



Oregon State University  
Utility Pole Research Cooperative

24th Annual Report  
September 30, 2004

Department of Wood Science & Engineering

J.J. Morrell  
C. Freitag  
H. Chen  
C. Love

<http://www.cof.orst.edu/coops/utilpole/>



# Cooperators

Arch Chemicals

Bonneville Power Administration

Dr. Wolman, GMBH

Genics Inc.

ISK Biosciences Inc.

New York State Electric and Gas

Osмосе Utilities Services, Inc.

Pacific Gas and Electric

Pacific Corp.

Pole Care, Inc.

Pole Maintenance Co. (Copper Care  
Wood Preservatives, Inc.)

Portland General Electric Company

The Southern Company

Western Wood Preservers' Institute



# PERSONNEL

## ADVISORY COMMITTEE

David Asgharian, Pacific Power  
James Cahill, Bonneville Power Administration  
Chris Damaniakes, Pacific Gas & Electric  
Brent Elton, Genics Inc  
Moira Fry, Pacific Gas and Electric Co.  
Randy Gross, Copper Care, Inc.  
Dennis Hayward, Western Wood Preservers' Institute  
Alan Holloman, Southern Co.  
Al Kenderes, New York State Electric & Gas Corp.  
Dr. Manfred Jung, Dr. Wolman GMBH  
Bill Mullenburg, Portland General Electric Company  
Alan Preston, CSI, Inc.  
David Reynolds, ISK BioSciences  
Rich Ziobro, Osmose Holdings, Inc.

## RESEARCH

### *Principle Investigator:*

Jeffrey J. Morrell, Professor, Department of Wood Science & Engineering (Wood Preservation),  
Oregon State University

### *Research Associates/Visiting Scientist:*

Jianju Luo, Department of Wood Science & Engineering, Oregon State University  
Michal Maoz, Department of Wood Science & Engineering, Oregon State University

### *Faculty Research Assistants:*

Hua Chen, Department of Wood Science & Engineering, Oregon State University  
Camille Freitag, Department of Wood Science & Engineering, Oregon State University  
Connie Love, Department of Wood Science & Engineering, Oregon State University

### *Graduate Students:*

Lori Elkins, M.S., Dept. of Wood Science & Engineering, Oregon State University  
Neil Melencion, Ph.D., Dept. of Wood Science & Engineering, Oregon State University  
Antonio Silva, Ph.D., Dept. of Wood Science & Engineering, Oregon State University  
Christoph Schauwecker, M.S., Dept. of Wood Science & Engineering, Oregon State University  
Adam Taylor, Ph.D., Dept. of Wood Science & Engineering, Oregon State University  
Ying Xiao, Ph.D., Dept. of Wood Science & Engineering, Oregon State University



# Table of Contents

## Objective I

DEVELOP SAFER CHEMICALS FOR CONTROLLING INTERNAL DECAY OF WOOD POLES .....	I-1
A. Effect of Temperature on Release Rates of MITC From MITC-Fume Ampules .....	I-1
B. Pre-Installation Fumigant Treatment of Douglas-fir Poles With MITC .....	I-3
C. Performance of Fluoride/Boron Rods in Douglas-fir Poles .....	I-5
D. Performance of Copper/Boron Paste as an Internal Remedial Treatment .....	I-8
E. Performance of Copper Amended Fused Boron Rods .....	I-15
Literature Cited .....	I-20

## Objective II

IDENTIFY CHEMICALS FOR PROTECTING EXPOSED WOOD SURFACES IN POLES .....	II-1
A. Evaluate Treatments for Protecting Field Drilled Bolt Holes .....	II-1
B. Develop Methods for Ensuring Compliance With Requirements for Protecting Field-Damage to Treated Wood .....	II-1
C. Ability of Topical Treatments to Limit Decay of Untreated Douglas-fir Timbers .....	II-5

## Objective III

EVALUATE PROPERTIES AND DEVELOP IMPROVED SPECIFICATIONS FOR WOOD POLES .....	III-1
A. Effects of Through Boring and Radial Drilling on Pole Strength Properties (Preliminary proposal of Lori Elkins) .....	III-1
B. Condition Assessment of Aging Douglas-fir Crossarms .....	III-22
C. Assessment of Bending Tests and Ground Penetrating Radar for Assessing Residual Strength of Western Redcedar Poles .....	III-50
D. Ability of External Pole Barriers To Limit Moisture Ingress Into Copper Naphthenate and Pentachlorophenol Treated Western Redcedar Poles .....	III-50
E. Effect of Pole Seasoning Methods on Residual Strength of Utility Poles ....	III-61
Literature Cited .....	III-66

Objective IV

PERFORMANCE OF EXTERNAL GROUNDLINE PRESERVATIVE SYSTEMS

- A. Performance of External Preservative Systems on Douglas-fir, Western redcedar, and Ponderosa Pine Poles in California ..... IV-1
- B. Performance of Selected Supplemental Groundline Preservatives in Douglas-fir Poles Exposed Near Corvallis, Oregon ..... IV-1
- C. Performance of External Treatments for Limiting Groundline Decay in Southern Pine Poles Near Beacon, New York ..... IV-1
- D. Performance of a Fluoride/Boron Bandage on Douglas-fir Pole Stubs ..... IV-4

Objective V

PERFORMANCE OF COPPER NAPHTHENATE-TREATED WESTERN WOOD SPECIES

..... V-1

Objective VI

ASSESS THE POTENTIAL ENVIRONMENTAL IMPACTS OF WOOD POLES

..... VI-1

- A. Assess the Potential for Preservative Migration From Pentachlorophenol Treated Poles in Storage Yards ..... VI-1
- B. Chemical Migration From Poles Treated With Inorganic Salt Preservative Preservative Systems ..... VI-7

Literature Cited ..... VI-15

Summary .....





**Objective I****DEVELOP SAFER CHEMICALS FOR CONTROLLING  
INTERNAL DECAY OF WOOD POLES**

Remedial treatments continue to play a major role in extending the service life of wood poles. While the first remedial treatments were broadly toxic, volatile chemicals, the treatments have gradually shifted to more controllable treatments. This shift has resulted in the availability of a variety of internal treatments for arresting fungal attack (Table I-1). In this section, we discuss the active field tests of the newer formulations as well as additional work to more completely characterize the performance of several older treatments.

Table I-1. Characteristics of internal remedial treatments for wood poles.

Trade Name	Active Ingredient	Conc. (%)	Toxicity (LD <sub>50</sub> rat)	Manufacturer
TimberFume	trichloronitromethane	96	205 mg/kg	Osmose Utilities Services, Inc.
WoodFume ISK Fume	sodium n-methyldithiocarbamate	32.1	1700-1800 mg/kg	Osmose Utilities Services, Inc. ISK Biosciences
MITC-FUME	methylisothiocyanate	96	305 mg/kg	Osmose Utilities Services, Inc.
Super-Fume UltraFume	Tetrahydro-3,5-dimethyl-2H-1,3,5-thiadiazine-2-thione (Dazomet)	98-99	320 mg/kg oral 2260 mg/kg dermal	Pole Care Inc. Copper Care Wood Preservatives, Inc.
Impel Rods	boron	100	>2000 mg/kg	Pole Care Inc.
Pole Saver Rods	boron/fluoride	58/24	>2000 mg/kg	Preschem Ltd.
Flurods	fluoride	98	105 mg/kg	Osmose Utilities Services, Inc.
Cobra-Rods	boron/copper	97/3	10000 mg/kg oral 5000 mg/kg dermal	Genics Inc.

**A. Effect of Temperature on Release Rates of MITC From MITC-Fume Ampules**

MITC-Fume has been commercially available for over 12 years, first as a glass encapsulated material and later in aluminum ampules. In both cases, the cap was removed and the tube was inserted, open end down, into the treatment hole. As with any encapsulated material, the time required for the chemical to move from the tubes and into the surrounding wood has important implications on efficacy. As a part of our initial evaluations of MITC-Fume, we established small scale trials to assess the rates of MITC release under varying temperature conditions. Eighteen untreated Douglas-fir pole sections (250 mm in diameter by 750 mm long) were obtained either freshly cut or air-seasoned. The objective of using green material was to determine if excess moisture would affect release rate. A single hole (205 mm long by 189 mm in diameter) was drilled at a 45 degree angle near the center of each pole section

and a single MITC-Fume ampule containing 29 g of MITC was added to the hole. The holes were plugged with rubber stoppers, and then sets of three poles each were stored at 5 C, outdoors at ambient temperatures (0 to 30 C) or at 32 C and 90 % relative humidity. The ampules were periodically removed and weighed to determine the rate of MITC release. As noted previously, ampules stored at 32 C lost most of their chemical within 1 year (Figure I-1). Ampules stored outdoors lost chemical more slowly and there was a slight, but noticeably more rapid release rate for pole sections that were initially seasoned. The reasons for these differences remain unclear. Ampules stored at ambient conditions required 4 to 8 years to lose all of the initial chemical, although the vast majority of chemical was lost within the first 4 years after treatment.

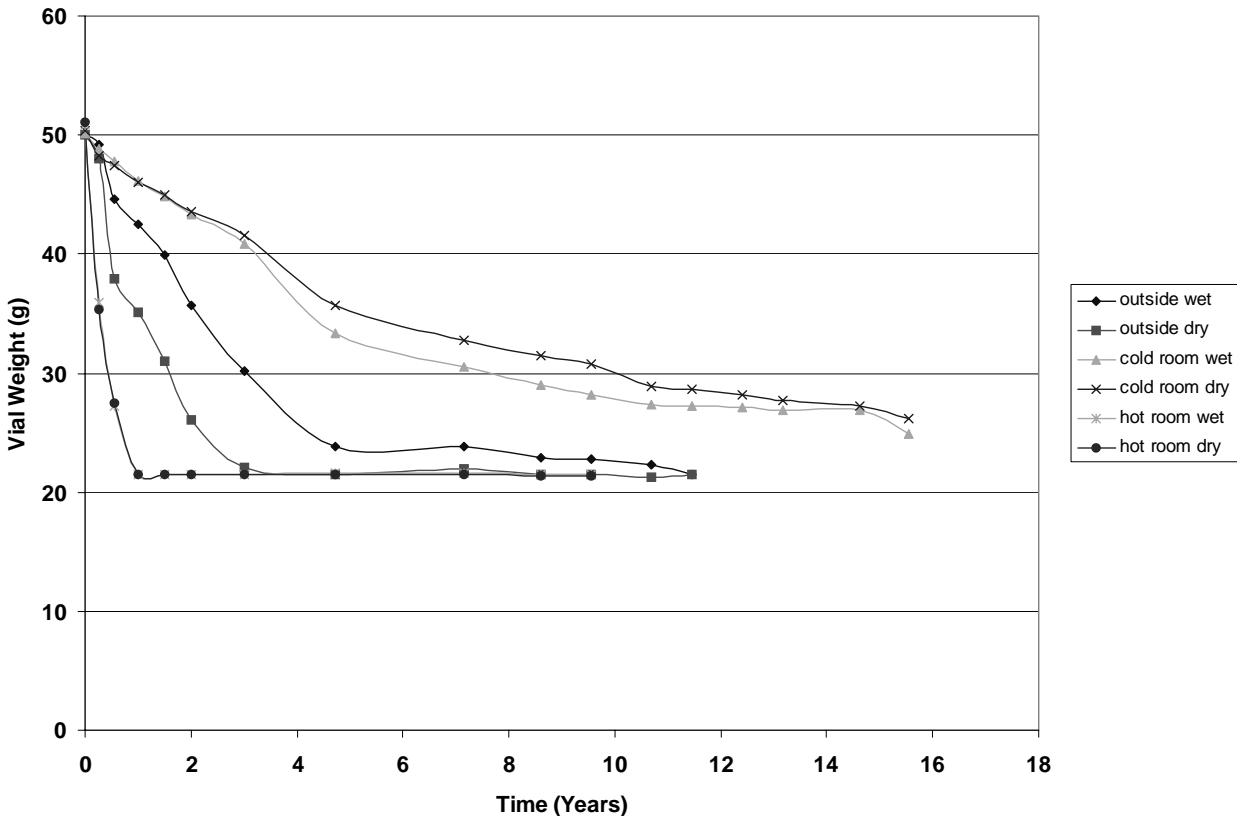

Figure I-1. MITC remaining in glass ampules installed in Douglas-fir pole sections exposed at 5 C, 32 C or ambient outdoor conditions.

Ampules stored at 5 C continue to lose chemical very slowly at rates that will require 25 to 30 years for the chemical to completely leave the ampule. MITC is an interesting chemical in that it sublimates directly from a solid to a gas at room temperature. Clearly, cooler temperatures retard this process. Conversely, decay fungi are only marginally active at 5 C, making it unlikely that any significant decay would occur under these conditions. Thus, the slow release of MITC may be attractive from a practical aspect for poles exposed in cooler climates. The only concern about this prolonged release would be that the ampules continue to retain active ingredient for many years. This might become a concern were the pole to be involved in a vehicle accident, since the ampule could be ejected from the hole, or the chemical could be released if the pole were cut through with a chainsaw. However, prior tests by the manufacturers have shown that even cutting through an ampule in the wood results in little or no airborne exposure to the chemical to workers. In addition, there is only 5 g of chemical in the tubes stored under the cooler condition at this time. Thus, there are minimal risks posed by long term residual chemical in the tubes.

## **B. Pre-Installation Fumigant Treatment of Douglas-fir Poles With MITC**

While MITC is currently sold in aluminum vials, the first tests with this chemical were actually performed using gelatin encapsulated MITC. The premise was that the gelatin would protect workers from contact with this caustic chemical during application, and then dissolve in water in the wood to release the chemical into the wood. This approach was dropped because of the cost of the gelatin as well as concerns about the potential for capsule damage prior to application.

One potential application for these systems, however, was the protection of the above ground zones of poles. In many coastal regions, wind-driven rain creates ideal conditions for decay well above the groundline. This problem can be both difficult to detect and costly. One approach to limiting this damage might be to apply fumigants along the length of the poles either at the treating plant or at a storage yard prior to installation. This process would limit the potential for internal decay and the holes could also be used for later supplemental treatment. We assessed the potential for using gelatin encapsulated MITC for this purpose in Douglas-fir transmission poles installed near North Bend, Oregon.

Twenty three pentachlorophenol treated Douglas-fir poles were treated by drilling holes (11.5 mm in diameter by 550 mm deep at 60 degree angles) in a spiral pattern from either 0 to 7.2 m above the intended groundline (10 % plus 0.6 m) or 1.2 m below the groundline to 6.0 m above this zone. Each pole received 1.15 L of chemical equally distributed among 6 treatment holes (192 ml per hole). A small amount of water (50 ml) was added to each hole, then the holes were plugged with penta-treated wood dowels. The poles were then installed in a transmission line located near North Bend, Oregon. The poles were inadvertently treated with chloropicrin in 1994, but this treatment should not interfere with our test.

MITC in the poles was assessed 11.5 and 19 years after treatment by removing increment cores from three locations around the poles 1.3 or 3.0 m above the groundline. Additional cores were taken at groundline or 0.3 m above this zone 19 and 11.5 years after treatment, respectively.

The outer 25 mm of the treated zone was discarded, then the outer 25 mm nearest the discarded treated zone and the inner 25 mm next to the pith of each core was placed into individual test tubes containing 5 ml of ethyl acetate. The remainder of each core segment was placed into a plastic straw, returned to the lab, plated onto malt extract agar in petri dishes, and observed over a 30 day period for fungal growth. Any growth was examined for characteristics of basidiomycetes, a class of fungi containing many important wood decayers.

The cores in ethyl acetate were extracted for a minimum of 48 hours, then the resulting extract was analyzed for residual MITC content by gas chromatography. The wood core was air-dried, then oven dried and weighed. MITC content was expressed as ug MITC per gram oven dried wood basis. For reference, chemical levels above 20 ug/g of wood are considered to be protective.

MITC was detectable at nearly all sample locations 19 years after treatment (Table I-2). Prior tests of MITC-FUME found that residual MITC levels declined sharply between 5 and 7 years. Chemical levels in the pre-installed poles had declined only slightly in most zones between 11.5 and 19 years. The differences probably reflect the relatively high dosages applied at pre-installation, since the current tests applied nearly four times as much chemical to the poles as was applied in the original MITC-FUME test. They may also reflect the differences in initial treatments since these poles were treated with pentachlorophenol in P9 Type A oil while the original test poles were treated with CCA. The results, however, do illustrate the potential benefits for long term protection of the aboveground zones of poles exposed to a high decay hazard.

Fungal isolations, while less useful because of the prior chloropicrin treatment, showed the lack of any decay fungi on the test poles, even 3.0 m above the groundline (Table I-3). The 3.0 m zone is less likely to have been affected by the chloropicrin treatment.

Table I-2. Residual MITC (ug/g ODW) in Douglas-fir poles 11.5 or 19 years after application of 1.15 L of MITC.

Pole #	ug MITC/ g O.D. Wood after 11.5 or 19 Years											
	0.0 m				1.3 m				3.0 m			
	inner		outer		inner		outer		inner		outer	
	11.5 yr	19 yr	11.5 yr	19 yr	11.5 yr	19 yr	11.5 yr	19 yr	11.5 yr	19 yr	11.5 yr	19 yr
25861	15.7	0.0	7.7	0.0	<b>35.9</b>	<b>24.8</b>	<b>35.0</b>	6.0	<b>51.2</b>	<b>33.8</b>	<b>40.7</b>	0.0
25863	<b>27.1</b>	<b>54.7</b>	<b>31.5</b>	<b>29.2</b>	17.7	<b>23.4</b>	19.9	18.1	<b>26.3</b>	<b>53.2</b>	<b>23.6</b>	13.6
25864	17.4	19.8	17.0	12.0	<b>35.0</b>	<b>21.9</b>	12.3	11.3	<b>25.1</b>	<b>23.0</b>	19.3	15.2
25866	17.5	<b>21.8</b>	10.6	<b>25.9</b>	<b>29.3</b>	<b>25.0</b>	<b>21.8</b>	17.1	<b>44.0</b>	<b>30.9</b>	<b>27.5</b>	<b>26.0</b>
25870	<b>33.2</b>	<b>23.0</b>	18.9	<b>22.9</b>	<b>42.0</b>	<b>23.3</b>	<b>20.6</b>	<b>22.1</b>	<b>69.2</b>	<b>39.8</b>	<b>30.4</b>	<b>27.7</b>
25873	13.1	<b>21.1</b>	<b>21.1</b>	<b>48.9</b>	<b>24.1</b>	<b>24.0</b>	12.6	<b>21.2</b>	<b>57.0</b>	<b>43.1</b>	<b>24.4</b>	<b>34.7</b>
25874	18.9	<b>23.1</b>	12.3	13.8	<b>57.9</b>	<b>32.5</b>	16.5	15.1	<b>43.8</b>	<b>46.7</b>	<b>45.0</b>	16.2
25875	<b>55.4</b>	<b>23.3</b>	16.6	<b>35.5</b>	<b>51.6</b>	<b>23.3</b>	<b>32.7</b>	<b>25.1</b>	<b>52.9</b>	<b>32.6</b>	<b>32.5</b>	<b>25.0</b>
25877	14.3	15.9	<b>21.9</b>	<b>34.6</b>	17.2	<b>30.4</b>	11.4	18.9	10.5	17.9	12.4	12.5
25878	<b>32.6</b>	<b>28.3</b>	<b>26.9</b>	<b>24.3</b>	<b>26.2</b>	<b>41.2</b>	18.5	18.0	<b>47.4</b>	<b>57.8</b>	16.6	<b>59.5</b>
25879	13.9	<b>20.4</b>	8.2	12.2	13.6	<b>21.4</b>	7.4	9.0	<b>46.1</b>	<b>27.2</b>	10.6	13.6
25882	<b>44.3</b>	<b>32.1</b>	<b>30.1</b>	<b>38.3</b>	<b>24.4</b>	<b>28.4</b>	19.2	12.0	<b>24.2</b>	<b>35.6</b>	15.8	19.5
25884	7.9	19.2	12.0	<b>22.9</b>	<b>32.2</b>	<b>21.2</b>	<b>29.7</b>	<b>32.7</b>	<b>63.7</b>	<b>45.3</b>	<b>51.3</b>	16.9
25888	10.6	<b>30.4</b>	<b>21.6</b>	<b>35.2</b>	10.6	<b>22.1</b>	9.1	15.5	<b>20.7</b>	<b>21.9</b>	12.8	18.5
25889	<b>45.8</b>	<b>26.7</b>	<b>46.0</b>	<b>30.4</b>	<b>54.6</b>	<b>25.8</b>	<b>23.8</b>	19.8	<b>55.8</b>	<b>36.6</b>	<b>24.5</b>	<b>23.7</b>
25891	<b>30.4</b>	<b>23.2</b>	<b>20.6</b>	<b>24.5</b>	<b>68.1</b>	<b>20.2</b>	<b>22.9</b>	11.2	<b>80.9</b>	<b>31.0</b>	<b>45.6</b>	14.1
Avg.	<b>24.9</b>	<b>24.0</b>	<b>20.2</b>	<b>25.7</b>	<b>33.8</b>	<b>25.6</b>	19.6	17.1	<b>44.9</b>	<b>36.0</b>	<b>27.1</b>	<b>21.0</b>
S.D.	14.2	10.9	10.0	12.1	17.0	5.4	8.1	6.6	19.2	11.2	12.9	13.0

Values in bold are above the toxic threshold of 20 ug/g O.D. Wood.

Table I-3. Isolation frequency of decay and non-decay fungi from Douglas-fir poles 11.5 or 19 years after application of 1.15 L of MITC.

Pole #	0.3 m above GL				1.3 m above GL				3.0 m above GL			
	decay		other		decay		other		decay		other	
	11.5 yr	19 yr	11.5 yr	19 yr	11.5 yr	19 yr	11.5 yr	19 yr	11.5 yr	19 yr	11.5 yr	19 yr
25861	0	0	0	100	0	0	0	0	0	0	0	50
25863	0	0	0	0	0	0	0	0	0	0	0	0
25864	0	0	0	0	0	0	0	0	0	0	0	0
25866	0	0	0	0	0	0	0	0	0	0	0	0
25866	0	0	0	0	0	0	0	0	0	0	0	0
25870	0	0	0	0	0	0	0	0	0	0	0	0
25873	0	0	0	0	0	0	0	0	0	0	0	0
25874	0	0	0	0	0	0	0	0	0	0	0	0
25875	0	0	0	0	0	0	0	0	0	0	0	0
25877	0	0	0	0	0	0	0	0	0	0	0	0
25878	0	0	0	0	0	0	0	0	0	0	67	0
25879	0	0	0	33	0	0	0	0	0	0	0	0
25882	0	0	0	0	0	0	0	0	0	0	0	33
25884	0	0	0	0	0	0	0	0	0	0	0	0
25888	0	0	0	0	0	0	0	0	0	0	0	0
25889	0	0	0	0	0	0	0	0	0	0	0	0
25890	0	0	0	0	0	0	0	0	0	0	0	0
25891	0	0	0	0	0	0	0	0	0	0	0	0
25892	0	0	0	0	0	0	0	0	0	0	0	0
Avg.	0.0	0.0	0.0	7.8	0.0	0.0	0.0	0.0	0.0	0.0	3.5	4.9
S.D.	0.0	0.0	0.0	25.1	0.0	0.0	0.0	0.0	0.0	0.0	15.4	14.1

The cultural results support the premise that the residual MITC continues to protect the poles almost 19 years after treatment. We will continue to monitor these poles to determine when chemical levels decline to the point where some retreatment might be advisable.

### **C. Performance of Fluoride/Boron Rods in Douglas-fir Poles**

Fluoride/boron rods are used in Australia for remedial treatment of internal decay in Eucalyptus poles. Although not labeled in the U.S, these rods have potential for use in this country. The rods contain 24.3 % sodium fluoride and 58.2% sodium octaborate tetrahydrate (Preschem, Ltd) and have a chalk-like appearance. In theory, the boron/fluoride mixture should take advantage of the properties of these two chemicals which have relatively low toxicity and can move with moisture through wood.

Pentachlorophenol treated Douglas-fir poles (250-300 mm in diameter by 3.6 m long) were set to a depth of 0.6 m and a series of three steeply sloping holes were drilled into each pole, beginning at groundline and moving upwards 150 mm and around the pole 90 or 120 degrees. A total of 70.5 or 141 g of boron/fluoride rod (3 or 6 rods per pole) was equally distributed among the three holes which were plugged with tight fitting wooden dowels. Each treatment was replicated on five poles.

Chemical movement was assessed 1, 2, 3, 5, 7, and 10 years after treatment by removing increment cores from three equidistant sites around each pole 300 mm below groundline (GL), 300 mm above GL and 800 mm above GL. The outer, treated shell (around 25 mm) was discarded, and the inner and outer 25 mm of each core was retained. Core segments from a given zone for the same sampling height were combined for the five poles in each treatment. The cores were then ground to pass a 20 mesh screen and the resulting sawdust was thoroughly mixed before being divided into two equal portions. One portion was extracted in hot water and analyzed for boron content using the Azomethine H method. The other sawdust portion was extracted in hot water, then the fluoride levels were measured using a specific ion electrode.

Fluoride levels were initially elevated in both the 3 and 6 rod treatments, but were all well below the presumed threshold for this chemical as an internal treatment (Figure I-2). A level of 0.6 kg/m<sup>3</sup> is necessary to protect wood from a fungal infestation while a level of 2.2 kg/m<sup>3</sup> may be required to kill an actively growing infestation. Fluoride levels tended to fall off sharply after the first year, even in the wetter belowground zones. Fluoride levels also tended to be slightly higher in poles treated with 3 rods in the 90 degree spacing, compared to the 120 degree spacing, but this effect was not apparent for the 6 rod treatment.

a.

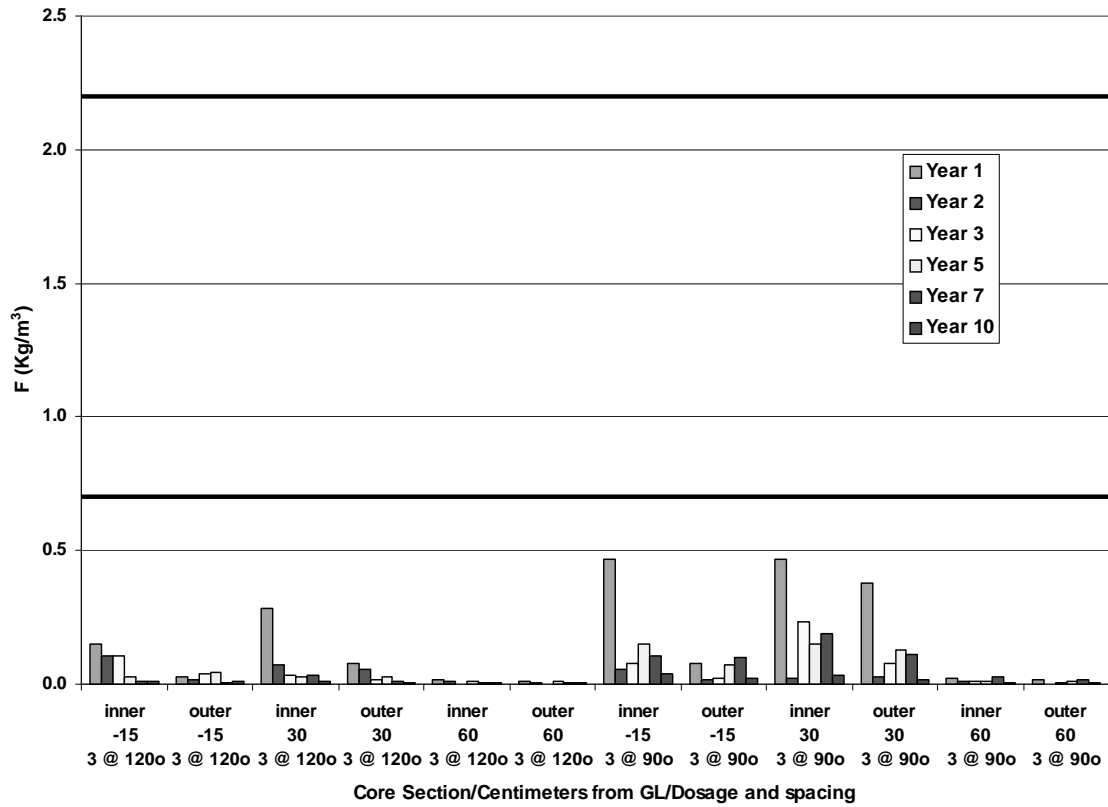

b.

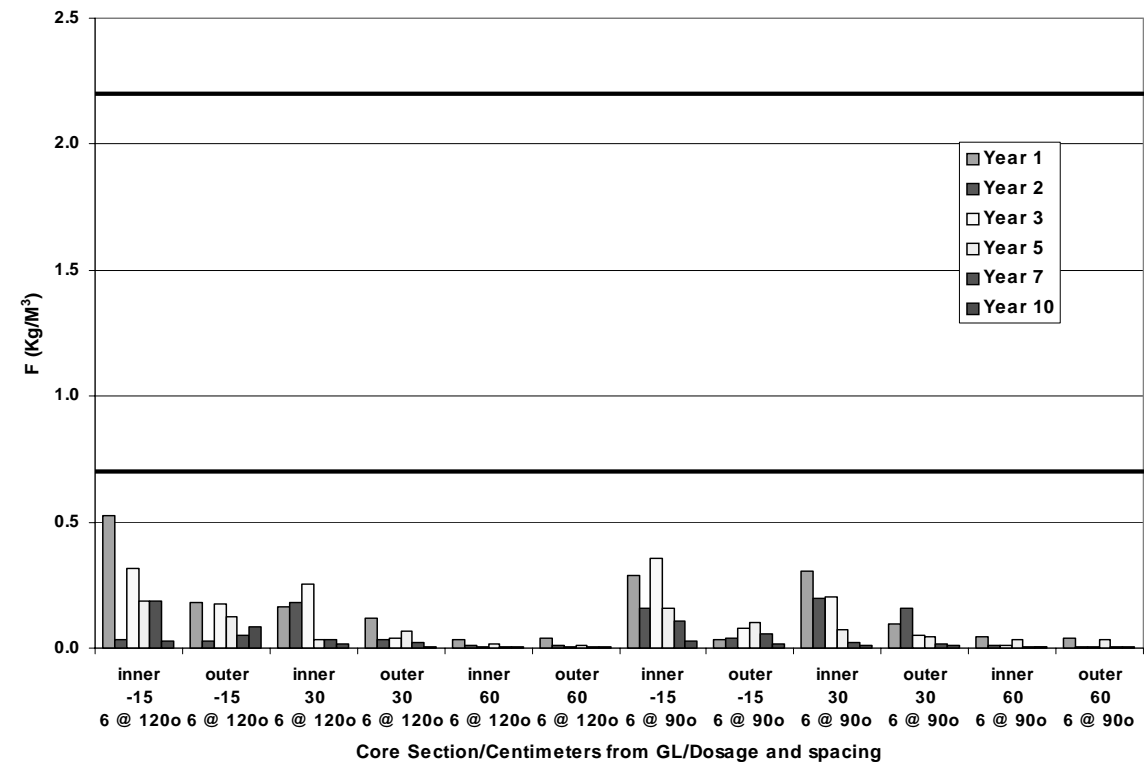

Figure I-2. Residual fluoride levels at selected distances from the groundline and wood surface (inner vs outer) in Douglas-fir pole sections 1 to 10 years after treatment with a) 3 or b) 6 fluoride/boron rods.

Boron levels in the 3 rod treatment were above the threshold below groundline and 300 mm above groundline one to five years after treatment in both the 90 and 120 degree spacings (Figure I-3). Chemicals levels then fell below the lower threshold at most locations. Chemical levels 600 mm above groundline were generally low throughout the test suggesting that upward movement from the rods was minimal.

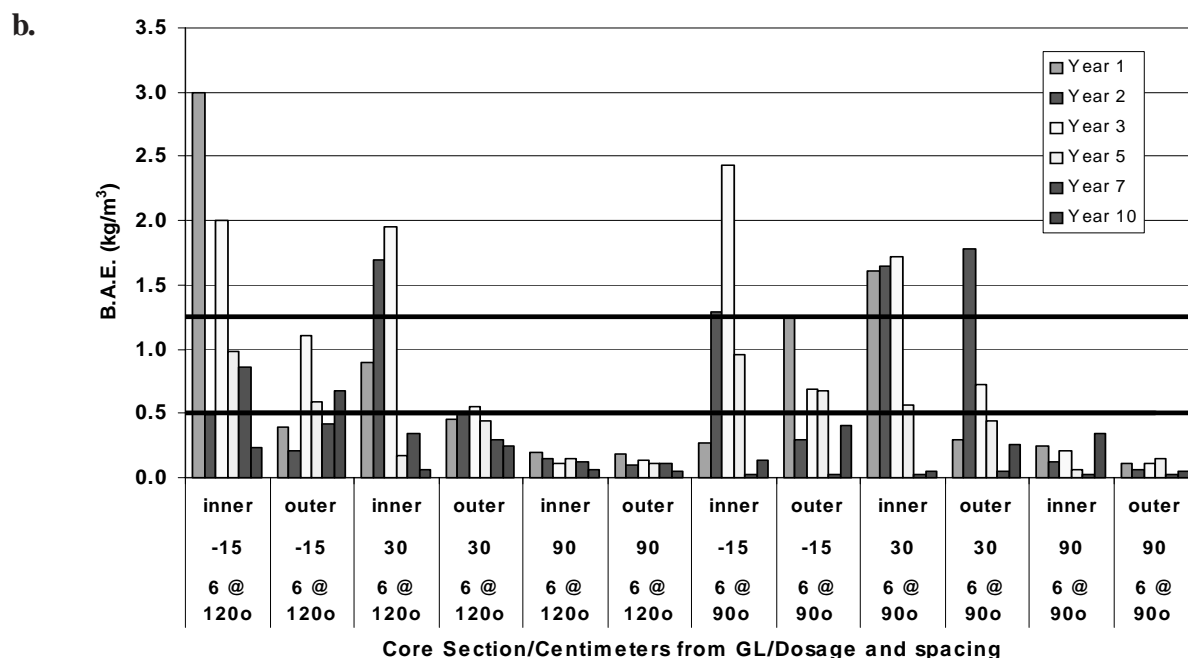
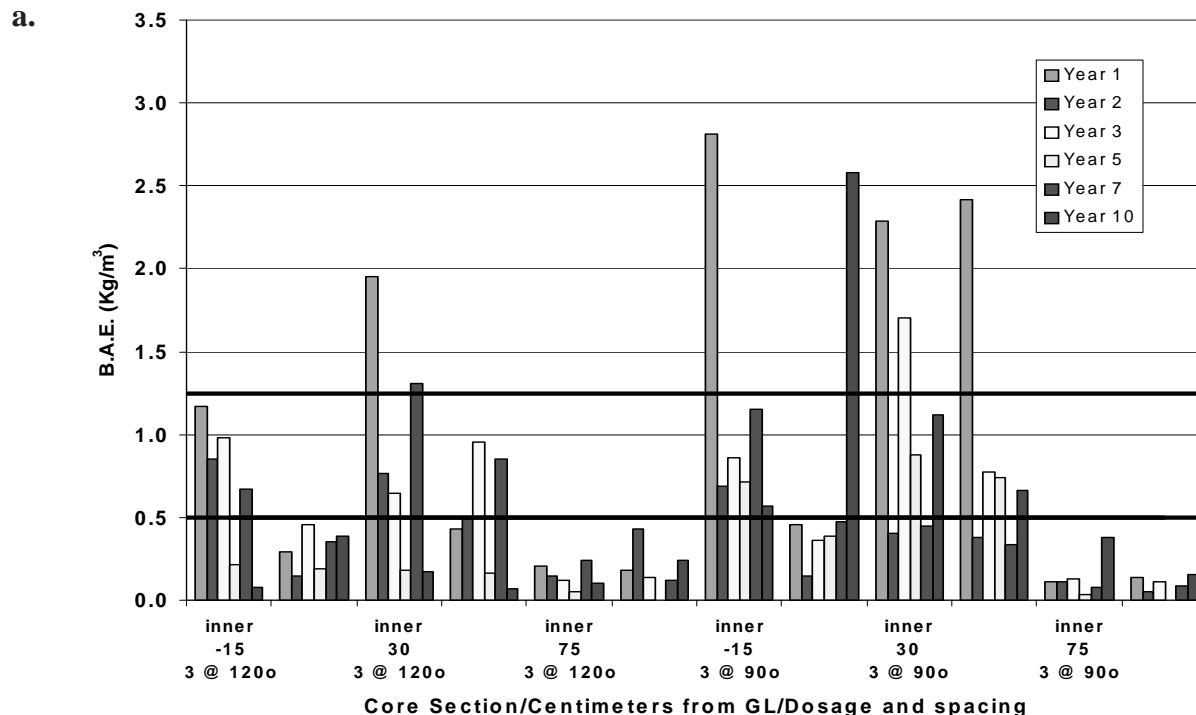

Figure I-3. Residual boron levels at selected distances from the groundline and wood surface (inner vs outer) in Douglas-fir pole sections 1 to 10 years after treatment with a) 3 or b) 6 fluoride/boron rods.



---

Boron movement in the 6 rod treatment tended to be higher over the course of the test, but was sometimes lower above the groundline and declined to below thresholds 7 years after treatment. Given the overall trends, it would be difficult to justify the use of 2 rods per hole.

The overall results after 10 years are consistent with the previous results. The fluoride, while potentially useful as a biocide, appears to move at low rates through the wood and its role in this system is questionable. Boron does appear to move well from the rods and remained at effective levels for 5 years after treatment at or near the groundline. As with many internal remedial treatments, it would be expected that fungal reinvasion would not occur immediately after the chemical has depleted to levels below the threshold level. For example, metam sodium is only detectable in wood for 3 to 5 years after treatment, but the treatment provides 7 to 10 years of protection against renewed fungal attack. We might expect similarly slow rates of recolonization with boron based treatments.

#### **D. Performance of Copper/Boron Paste as an Internal Remedial Treatment**

While the copper naphthenate/ boron paste is typically sold as an external supplemental preservative, it is also labeled for internal remedial treatment. We assessed the potential efficacy of this system in pentachlorophenol treated Douglas-fir pole sections (250-300 mm in diameter by 3.0 m long) that were set to a depth of 0.6 m. Three holes were drilled beginning at groundline and moving upward 150 mm and around the pole 120 degrees. Ten poles each received 150 or 300 g of a paste containing 18.16 % amine copper naphthenate and 40 % sodium tetraborate decahydrate. The chemical was applied using a grease gun and then the holes were plugged with tight fitting wooden dowels.

Chemical movement was assessed 3, 5, 8, 10 and 15 years after treatment by removing increment cores from three equidistant sites at ground line as well as 75, 150, 225 and 300 mm above groundline. The outer 25 mm of treated shell was removed and discarded, then the remaining core was divided into inner and outer halves. The cores from a given height and treatment were combined and ground to pass a 20 mesh screen. The resulting sawdust was first analyzed for copper by x-ray fluorescence spectroscopy, then the dust was hot-water extracted and the resulting extract was analyzed for boron using the Azomethine H method.

Copper levels in poles treated with 150 g of the copper/boron paste were extremely low throughout the course of the test and never approached what would be considered a protective level (Figure I-4). Copper levels in the 300 g treatment were considerably higher over 15 year sampling period. (Figure I-5). Levels are higher within the treatment zone and decline as distance from the treatment increases. While the amine copper naphthenate is presumed to have greater mobility in wood in the presence of moisture, the effects tend to decline once the wood has dried. Thus, the limited copper movement in both treatments is consistent with the premise that the copper component in this system is primarily present to protect the area around the treatment site. Similar trends have been noted in our external groundline tests.

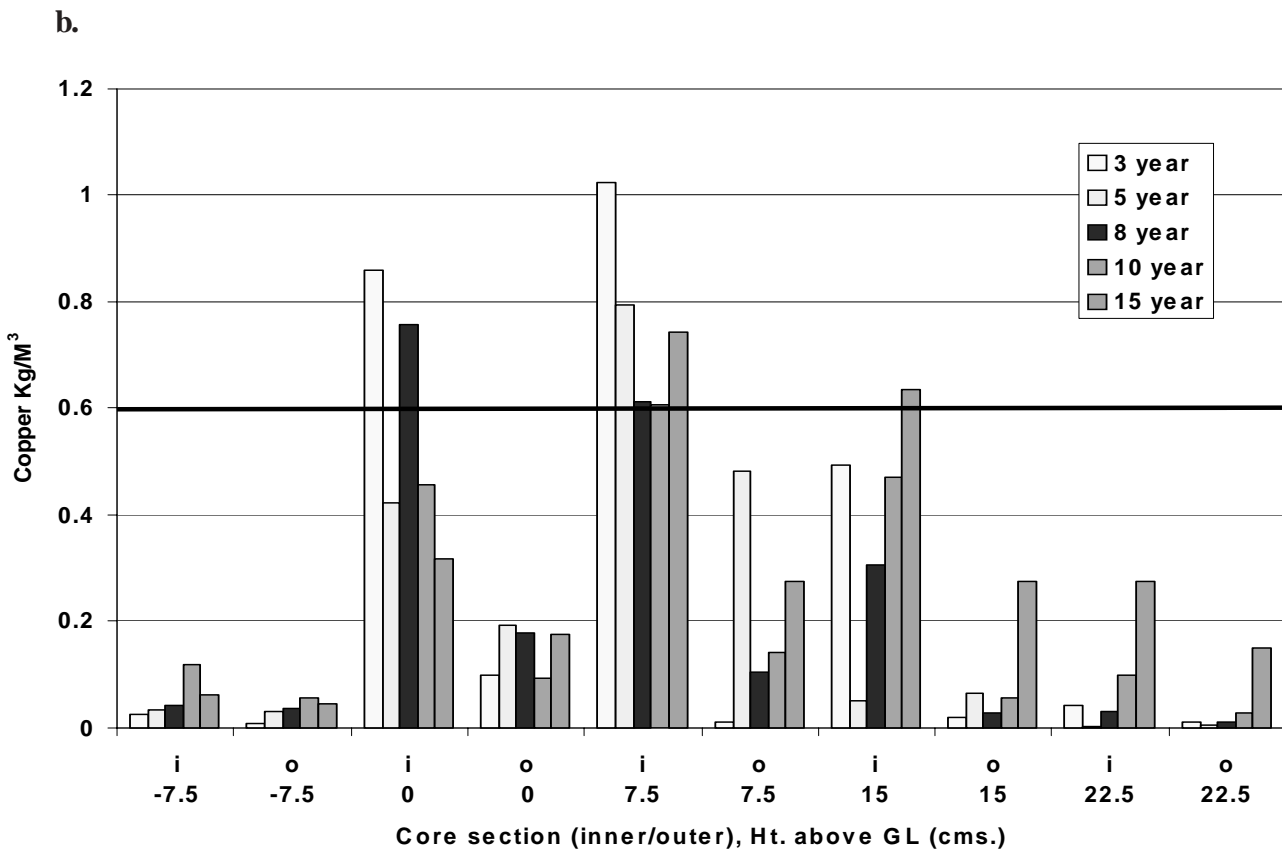
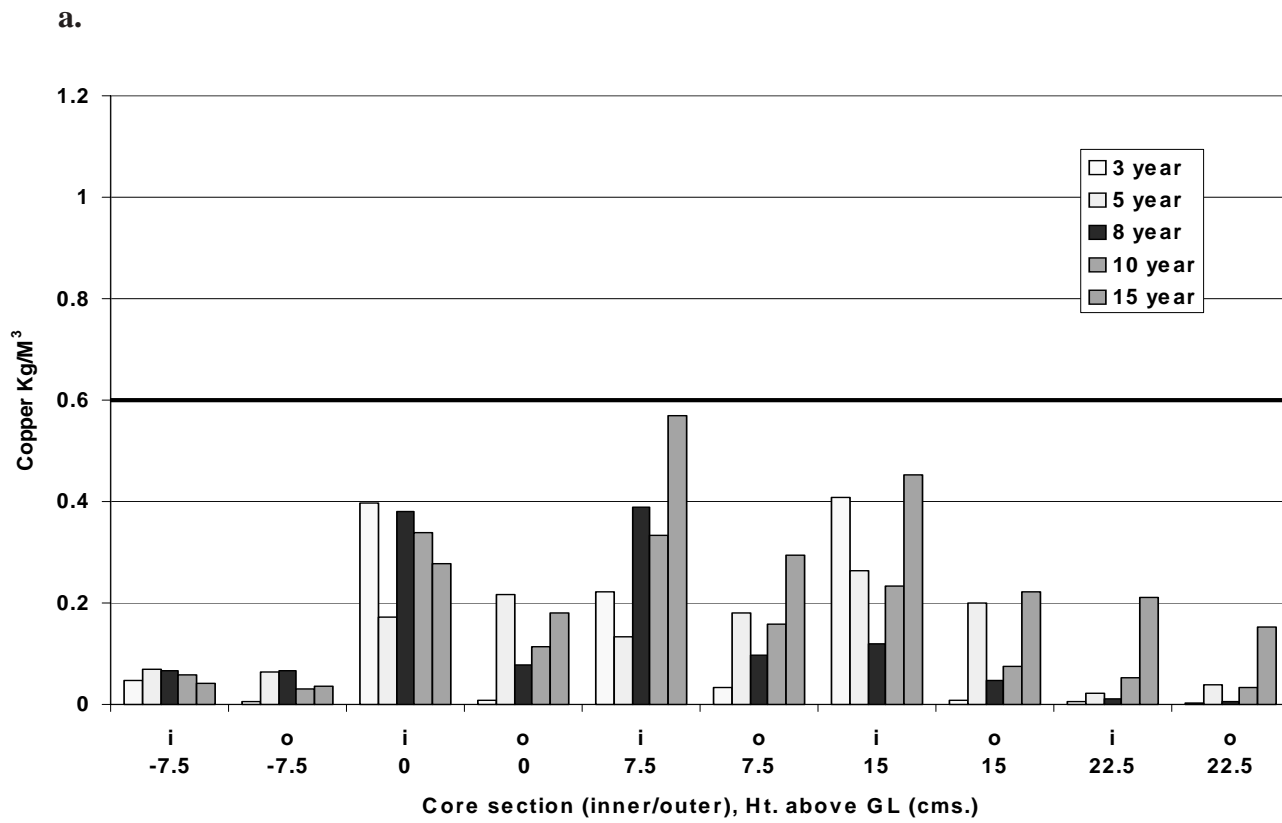

Figure I-4. Residual copper in Douglas-fir poles 3 to 15 years after treatment with a) 150 g or b) 300 g of a copper naphthenate/boron paste

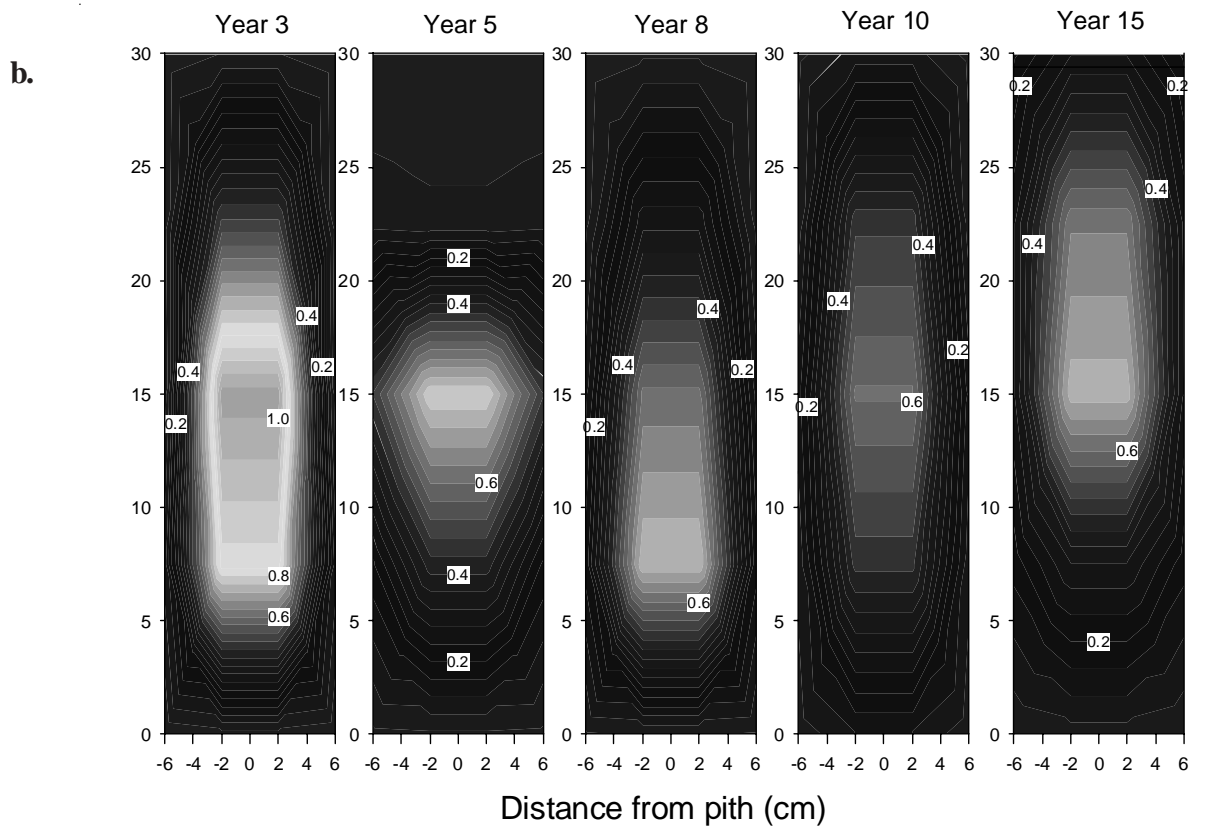
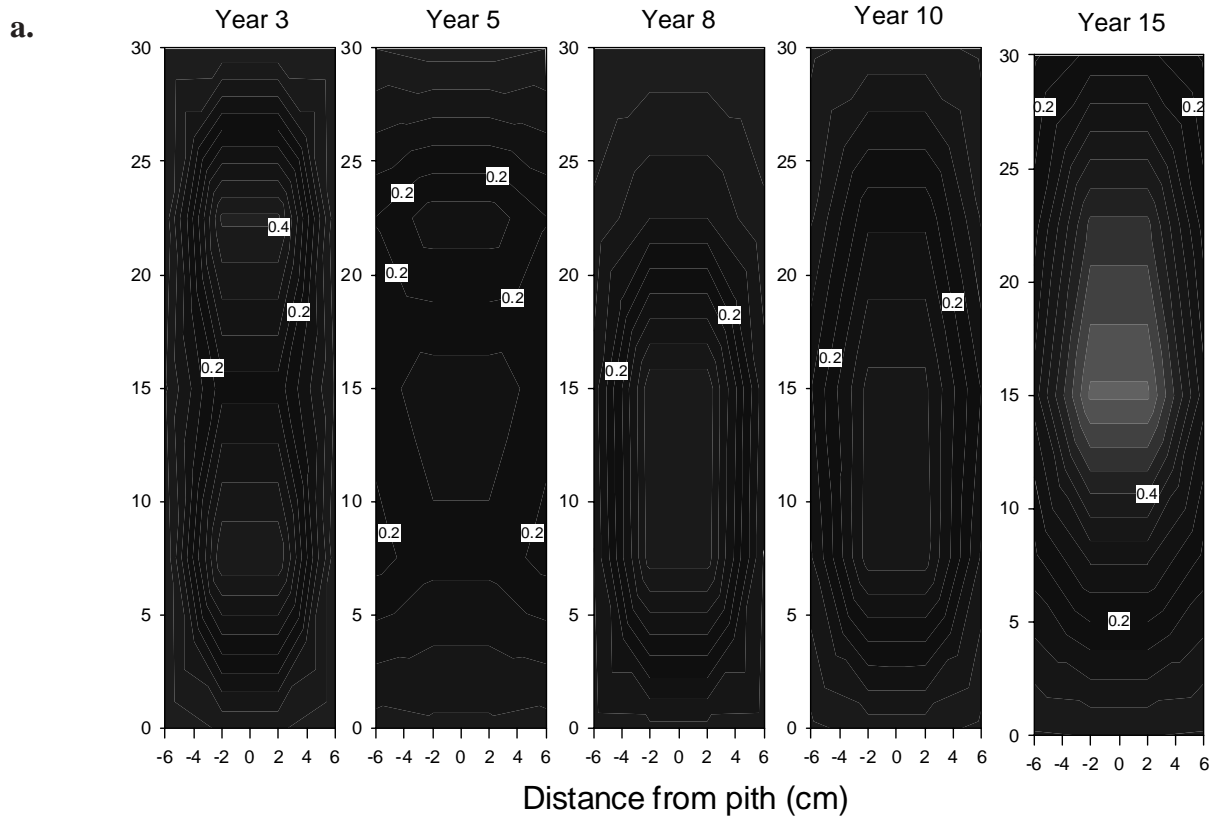

Figure I-5. Maps showing residual copper naphthenate (as Cu) distribution at selected distances above ground and inward from the surfaces of Douglas-fir poles 3 to 15 years after treatment with a) 150 g or b) 300 g of a copper naphthenate/boron paste.

Boron levels in poles treated with 150 g of the copper naphthenate/boron paste were well above the threshold in the entire 3.0 m sampling zone 3 years after treatment, then declined slightly after another two years (Figure I-6). Boron levels plummeted to below threshold levels 8 years after treatment and little boron was detectable from then onward (Figure I-7). A similar trend was noted in the 300 g treatment, but some boron was detectable in the middle of the original treatment zone 8 years after treatment. Boron levels were around the lower threshold 10 and 15 years after treatment with both dosages (Figure I-6).

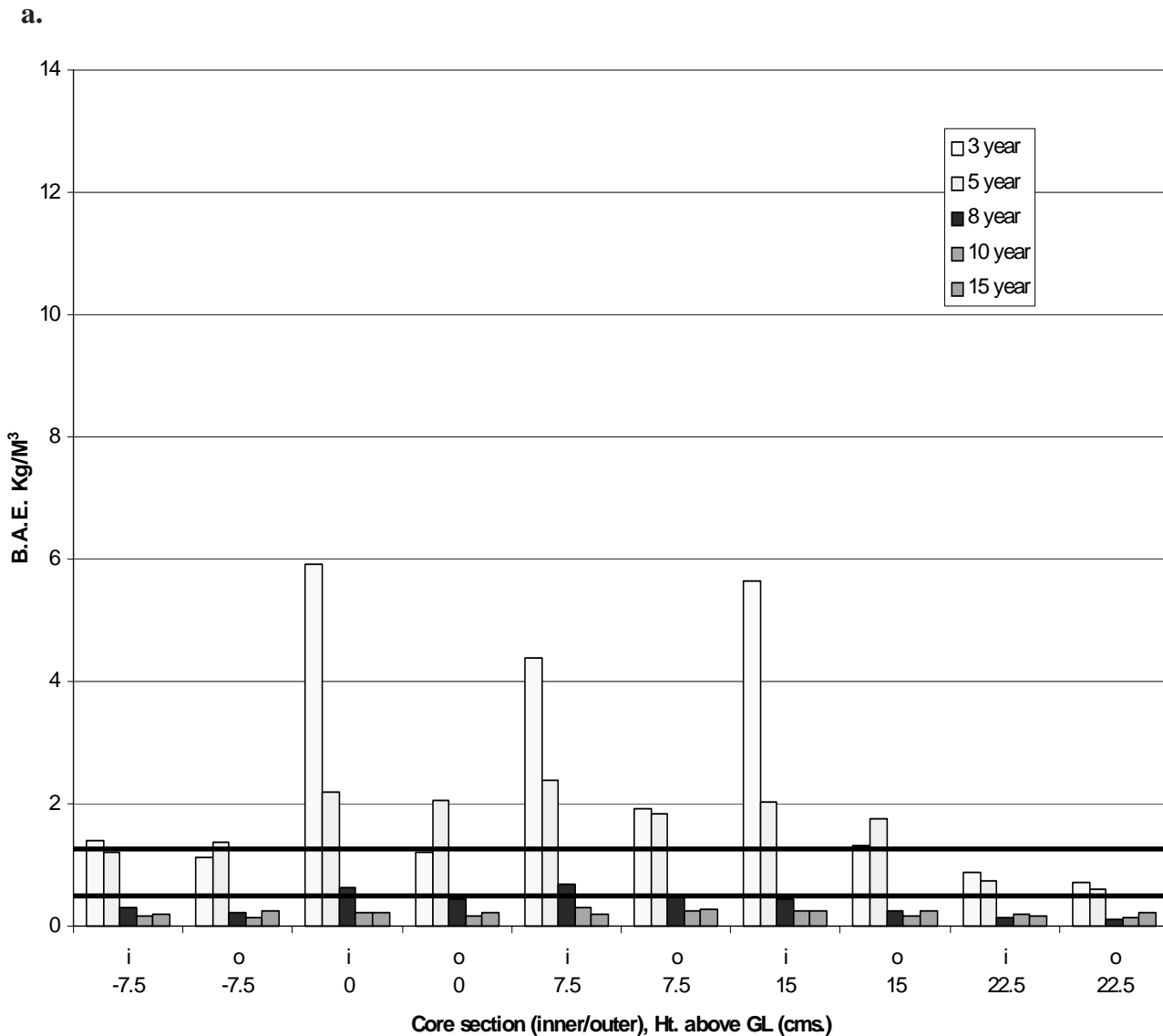

Figure I-6 Residual boron distribution in Douglas-fir poles 3 to 15 years after treatment with a) 150 g or b) 300 g of a copper naphthenate/boron paste

b.

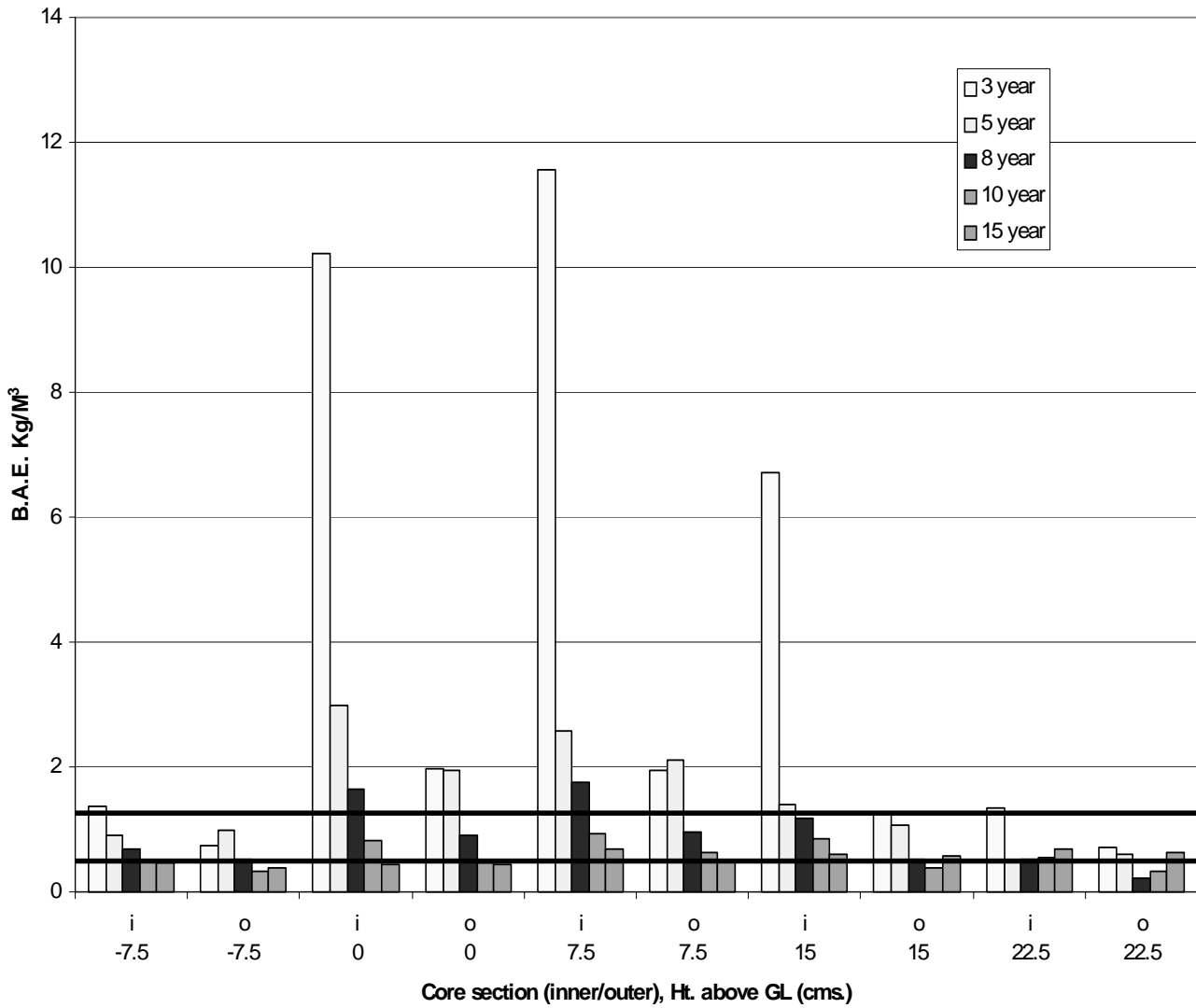
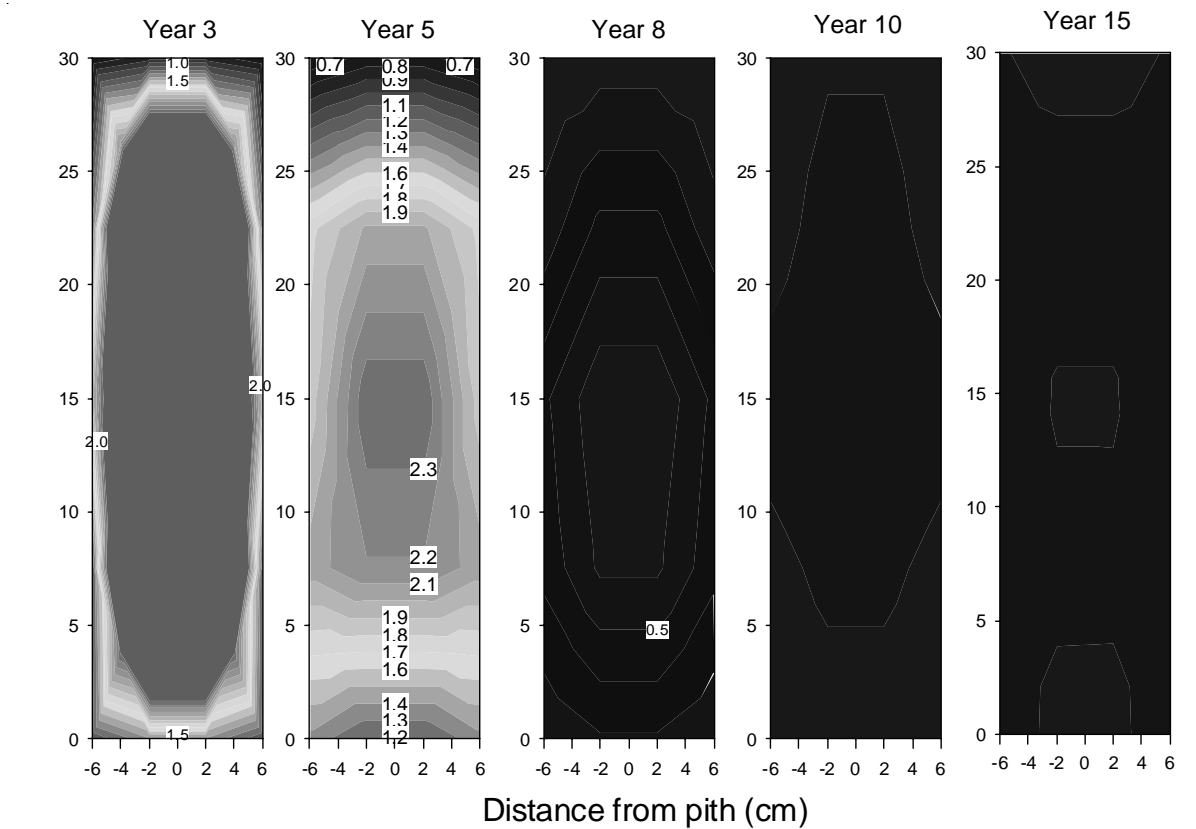

Figure I-6 Residual boron distribution in Douglas-fir poles 3 to 15 years after treatment with a) 150 g or b) 300 g of a copper naphthenate/boron paste

**a.**



**b.**

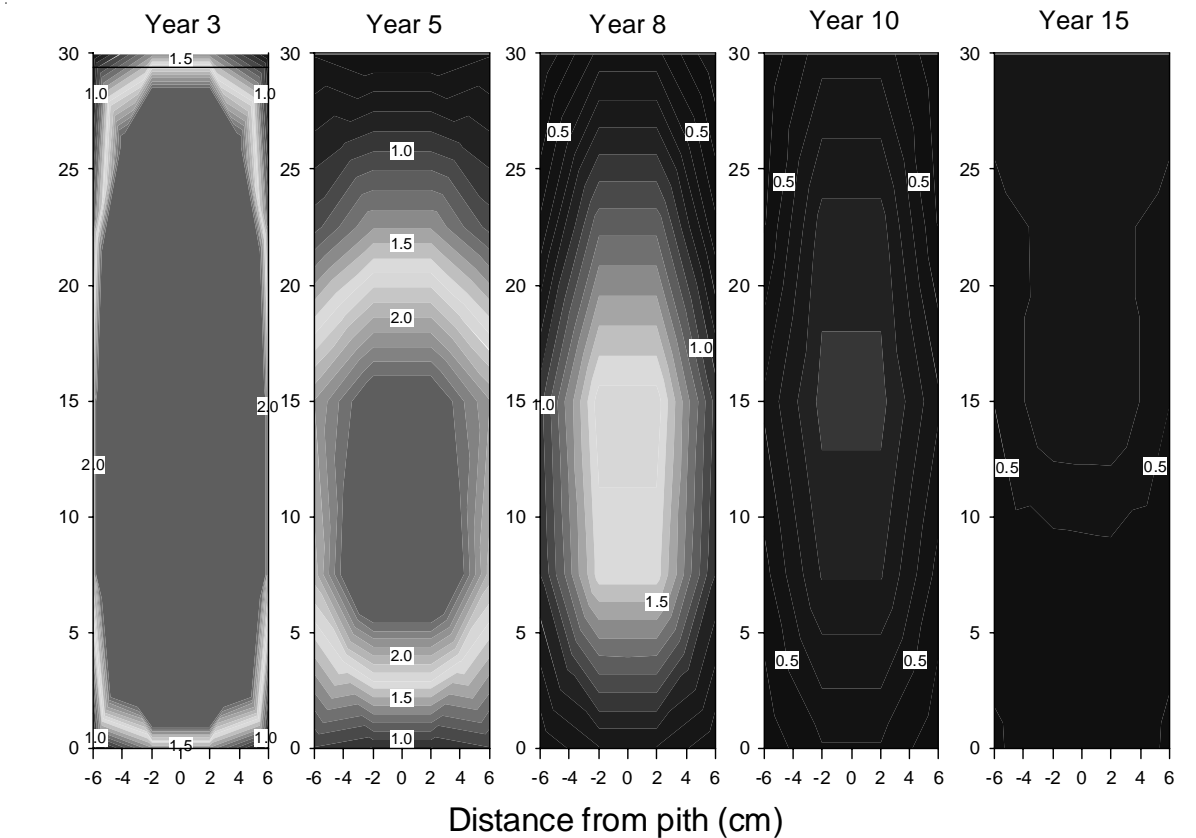

Figure I-7. Maps showing residual boron distribution at selected distances above ground and inward from the surfaces of Douglas-fir poles 3 to 15 years after treatment with a) 150 g or b) 300 g of a copper naphthenate/boron paste.

The results indicate that the copper naphthenate/boron paste was able to move to protective levels within the groundline zone, but this protective effect declined between 5 and 8 years after treatment. These results are consistent with many other internal remedial treatments and suggest that overall performance of this internal treatment should be similar as well.

### E. Performance of Copper-Amended Fused Boron Rods

The ability of boron and copper to move from fused rods was assessed by drilling holes perpendicular to the grain in pentachlorophenol treated Douglas-fir poles beginning at the groundline and then moving upward 150 mm and either 90 or 120 degrees around the pole. The poles were treated with either 4 or 8 copper/boron rods or 4 boron rods. The holes were then plugged with tight fitting plastic plugs. Chemical movement was assessed 1 and 2 years after treatment by removing increment cores from locations 150 mm below groundline as well as at groundline, and 300 or 900 mm above this zone. The outer, treated shell was discarded, then the core was divided into inner and outer halves. The cores from a given height and treatment were combined and then ground to pass a 20 mesh screen. The sawdust was first analyzed for copper by x-ray fluorescence spectroscopy, and then extracted in hot water. The resulting extract was analyzed for boron content using the azomethine H method.

Copper levels in poles treated with 4 rods were slightly elevated at groundline in the inner zones of poles treated using both the 90 and 120 degree treating patterns, but even these levels were well below the threshold for wood protection (Figure I-8). Copper was barely detectable away from these zones. Copper levels in the 8 rod treatment tended to be lower than those found with the 4 rod treatment. While the lower levels appear to be counterintuitive, they are consistent with previous tests of water diffusible systems. In many cases, higher dosages appear to slow initial chemical movement, possibly as the rods sorb moisture from the surrounding wood, thereby reducing water available for diffusion to occur.

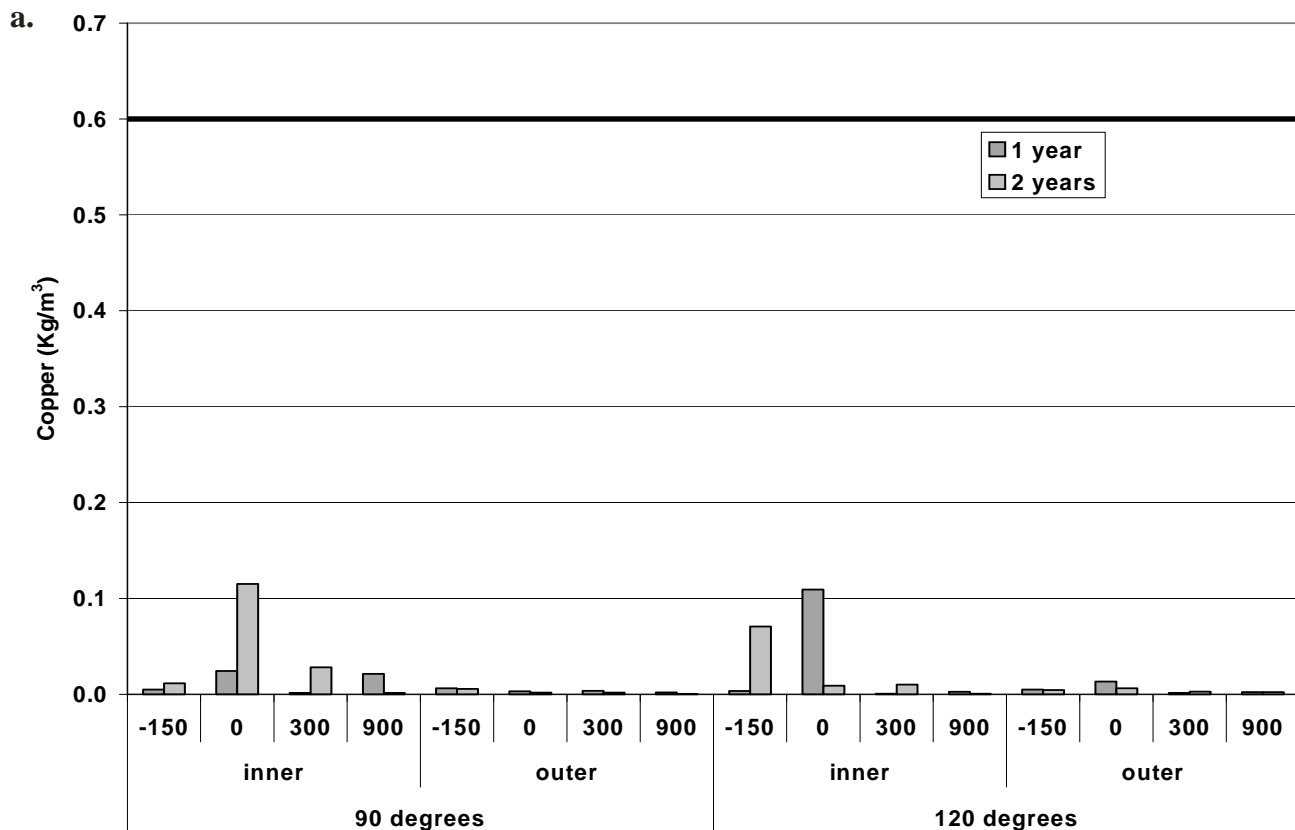

Figure I-8. Residual copper in Douglas-fir poles 1 and 2 years after treatment with a) 4 or b) 8 copper/boron rods

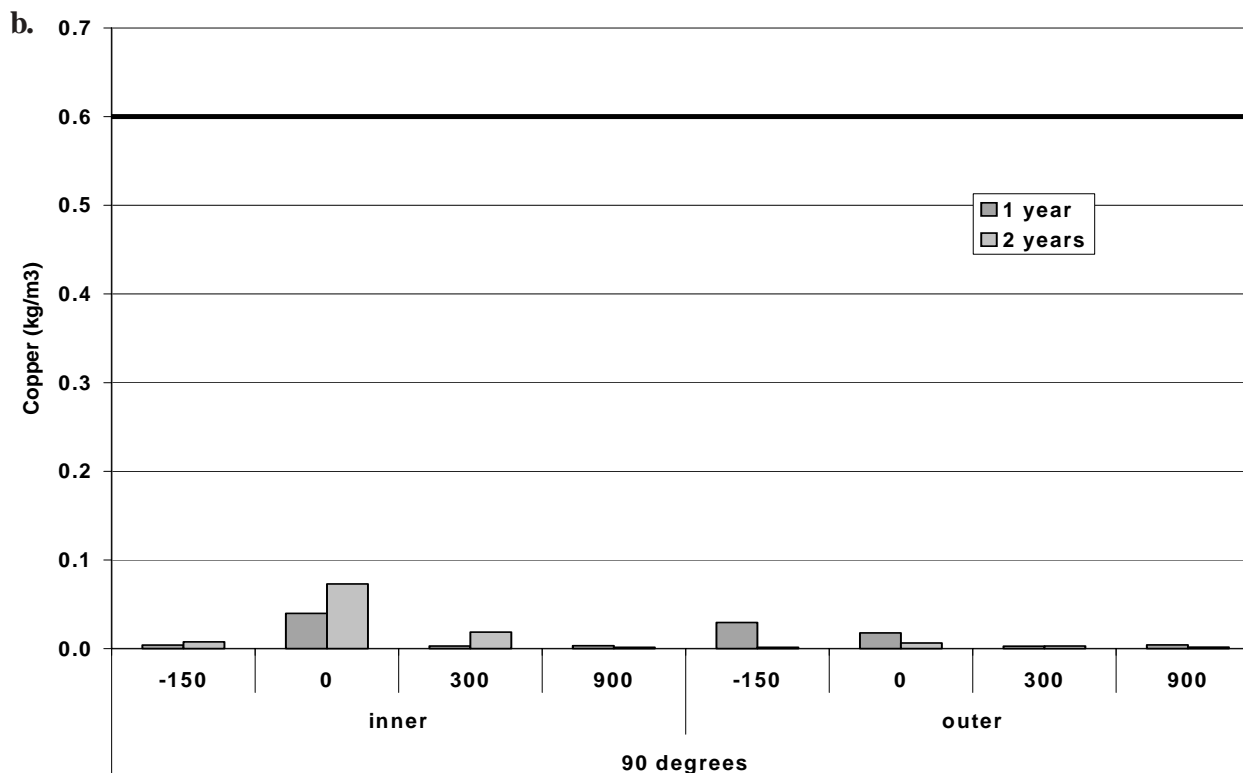

Figure I-8. Residual copper in Douglas-fir poles 1 and 2 years after treatment with a) 4 or b) 8 copper/boron rods

Boron levels in the inner zones of poles receiving 4 copper/boron rods were above the threshold for internal protection at and below groundline 2 years after treatment regardless of hole orientation (Figure I-9). Boron levels were at or slightly below the threshold 300 mm above groundline. These results suggest that the boron is diffusing well from the rods. Boron levels in the outer zones tended to be lower and were only approaching the lower threshold at groundline 2 years after treatment.

Boron levels in the boron rods were sometimes slightly higher than those for the copper/boron rods, but the differences appeared to be slight. Once again, the boron levels below groundline and at groundline were at or above the threshold.

Boron levels in poles treated with 8 copper/boron rods tended to be lower than those found with the 4 rod treatment, again suggesting that excessive chemical in the hole retards boron distribution. As a result, more chemical may not necessarily be the best approach to rapid decay control when these systems are employed. Instead, supplemental moisture addition may be a more fruitful approach to enhance boron movement and more quickly arrest fungal attack.

Cultural results of wood removed from the boron and copper/boron rod treated poles suggests that the poles are being invaded by a number of non-decay fungi at or near groundline. Basidiomycete isolations were minimal and did not appear to be tied to any particular treatment (Table I-4). The comparative results suggest that there was little difference in boron movement from the two types of rods.



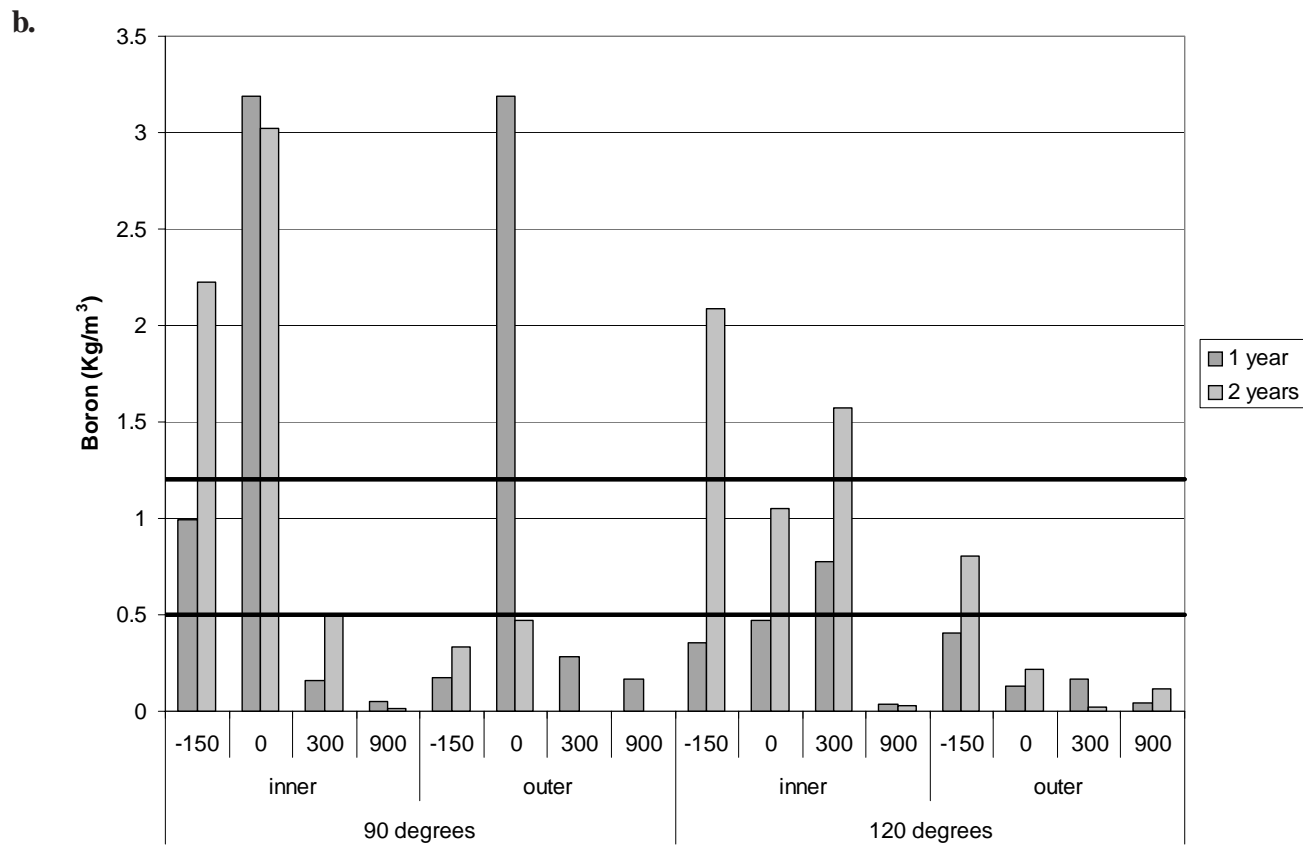
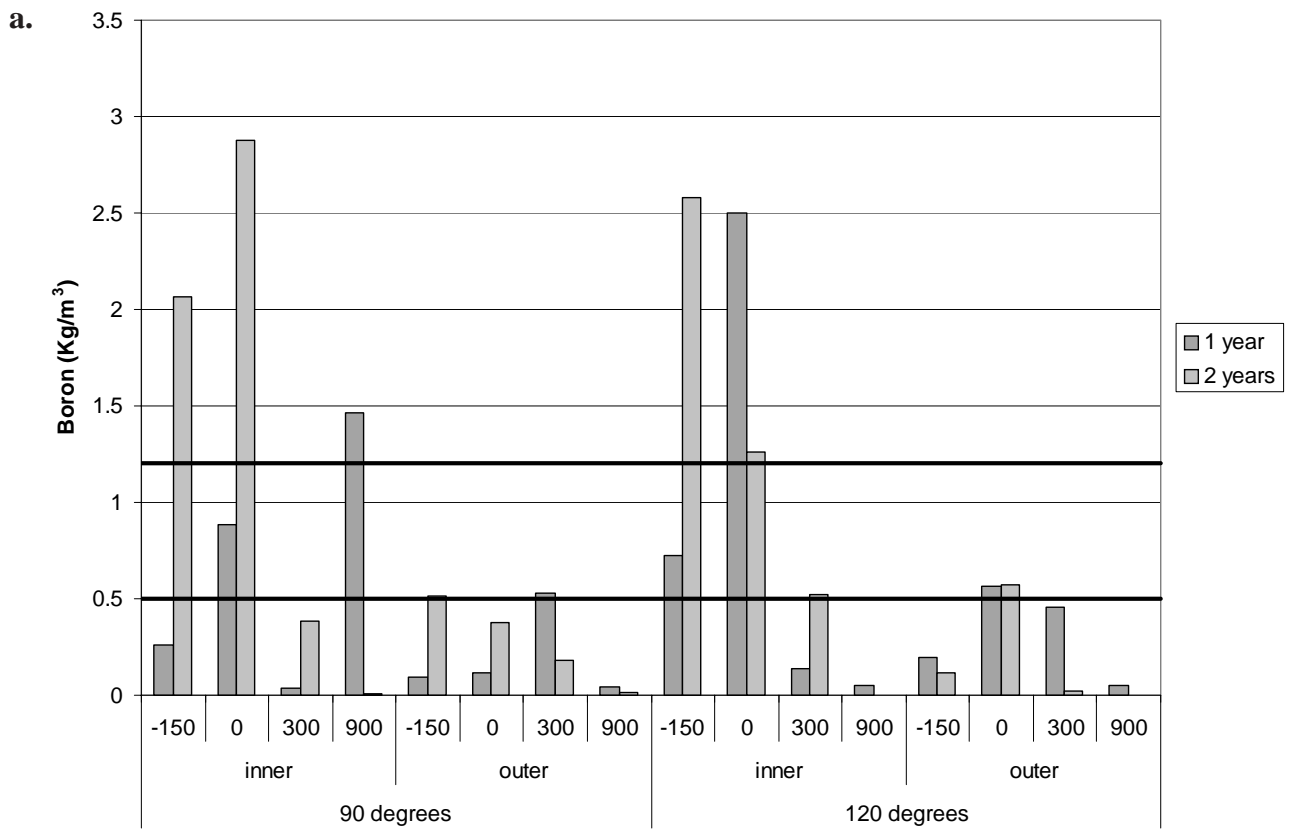

Figure I-9. Residual boron in Douglas-fir poles 1 and 2 years after treatment with a) 4 copper/boron rods, b) 4 boron rods, or c) 8 copper/boron rods.

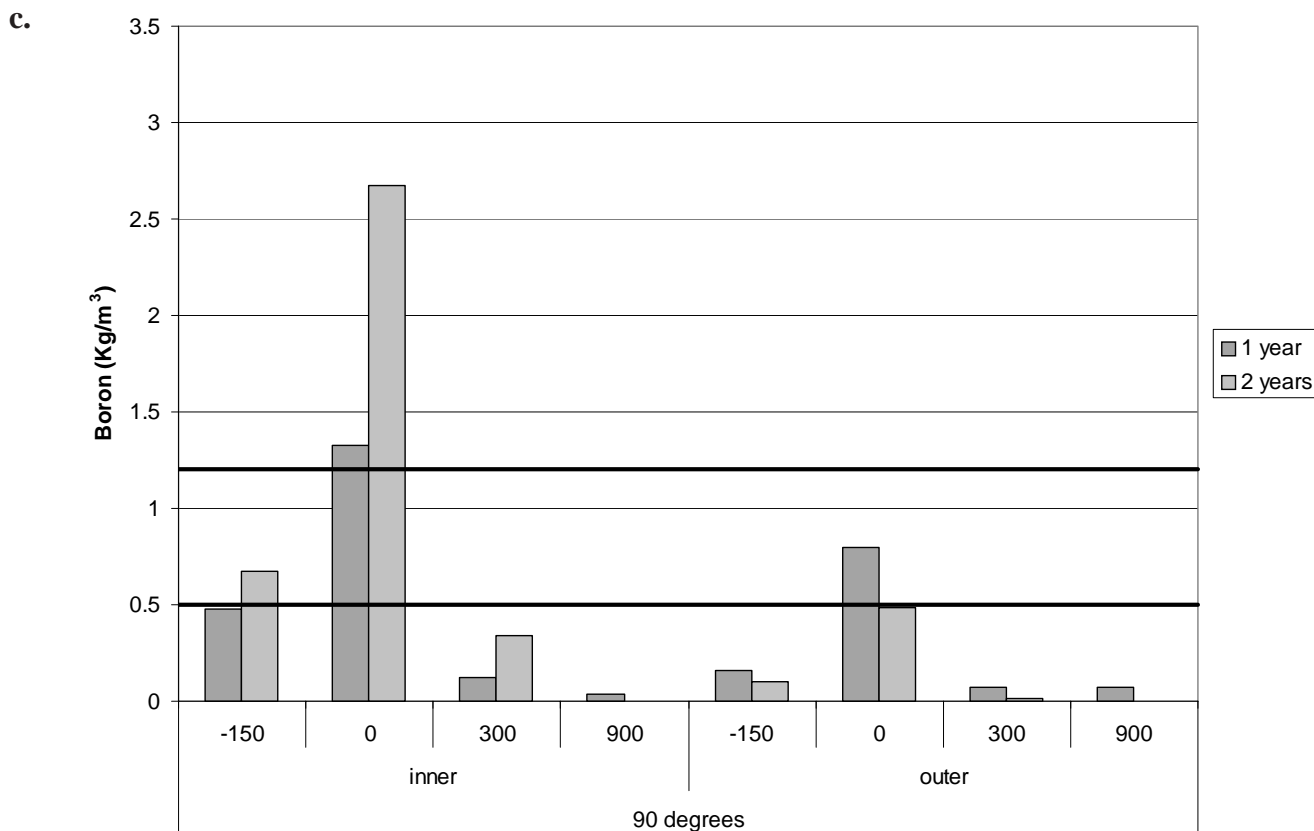

Figure I-9. Residual boron in Douglas-fir poles 1 and 2 years after treatment with a) 4 copper/boron rods, b) 4 boron rods, or c) 8 copper/boron rods.

Table I-4. Isolation frequencies of decay and non-decay fungi from boron or copper/boron rod treated Douglas-fir poles 1 and 2 years after treatment.

Treatment Spacing	Ht Above GL (mm)	4 Cobra Rods				4 Impel Rods				8 Cobra Rods			
		Decay Fungi		Other Fungi		Decay Fungi		Other Fungi		Decay Fungi		Other Fungi	
		1 yr	2 yr	1 yr	2 yr	1 yr	2 yr	1 yr	2 yr	1 yr	2 yr	1 yr	2 yr
90°	-150	0	0	7	33	0	0	7	20	0	0	7	7
	0	0	0	10	20	0	10	10	10	0	0	0	0
	300	0	0	20	10	0	0	0	0	0	0	0	20
	900	0	7	7	0	0	7	0	0	0	0	7	7
120°	-150	0	0	40	33	0	7	0	13	--	--	--	--
	0	0	0	0	20	0	0	0	10	--	--	--	--
	300	0	0	0	0	0	0	0	0	--	--	--	--
	900	0	0	13	0	0	0	20	0	--	--	--	--

---

---

## Literature Cited

- American National Standards Institute (ANSI). 1995. ANSI Standard for wood poles. Specifications and dimensions. ANSI 05.1. ANSI, New York, NY. 126 pages.
- American Wood Preservers Association. 2002. Standard C4-99. Poles: preservative treatment by pressure processes. In: AWP Book of Standards. Granbury, TX.
- Becker, G. 1976. Treatment of wood by diffusion of salts. International Research Group on Wood Preservation. Documents No. IRG/WP/358. Stockholm, Sweden.
- Brooks, K.M. 1997. Literature review and assessment of the environmental risks associated with the use of ACZA treated wood products in aquatic environments. Western Wood Preservers Institute Vancouver, WA. 99 pages.
- Brucato, M. 1994. Reduced woodpecker damage in ACZA treated utility poles. Proceedings American Wood Preservers=Association 90:114.
- Chudnoff, M., W.E. Eslyn, and R. Wawriw. 1977. Effectiveness of groundline treatments of creosoted pine poles under tropical exposures. Forest Products Journal 28(4):28-32.
- Conklin, S.W. 2001. Is Florida over-reacting: Modeling CCA treated wood. Proceedings American Wood Preservers=Association 97:109-114.
- Cooper, P.A., D. Jeremic, J.L. Taylor, Y.T. Ung, and F. Kazi. 2001. Effect of humic acid on leaching of CCA from treated wood. Forest Products Journal 51(9):73-77.
- Dahlgren, S.E. and W.H. Hartford. 1972. Kinetics and mechanisms of fixation of Cu-Cr-As wood preservatives. II. Fixation of Boliden K33. *Holzforschung* 26(3):105-113.
- DeGroot, R.C. 1981. Groundline preservative treatments of southern pine posts. Research Paper FPL-409. U.S. D.A. Forest Service, Forest Products Laboratory, Madison, Wisconsin
- Morrell, J.J., M.A. Newbill, G.G. Helsing, and R.D. Graham. 1998c. Surface treatments protecting untreated Douglas-fir timbers from internal decay. *Forest Products J.* 48(5):63-66.
- Morrell, J.J., P.G. Forsyth, and M.A. Newbill. 1994a. Distribution of biocides in Douglas-fir poles 42 months after application of groundline preservative systems. *Forest Products Journal* 44(6):24-26.
- Morrell, J.J. and J. Huffman. Copper, chromium, and arsenic levels in soils surrounding posts treated with chromated copper arsenate (CCA). *Wood and Fiber Science* (in press)
- Morrell, J.J., D. Keefe, and R.T. Baileys. Copper, zinc, and arsenic in soil surrounding Douglas-fir poles treated with ACZA. *J. Environmental Quality* (in press).
- Morrell, J.J., M.A. Newbill, and C.M. Sexton. 1994b. Capacity of surface and internal groundline treatments to protect untreated Douglas-fir poles. *Holzforschung* 48:113-116.

- DeGroot, R.C., T.W. Popham, L.R. Gjovik, and T. Forehand. 1979. Distribution gradients of arsenic, copper and chromium around preservative-treated wooden stakes. *J. of Environmental Quality* 8(1):39-41.
- Leutritz, J., Jr. and G.Q. Lumsden. 1962. The groundline treatment of standing southern pine poles. *Proceedings American Wood Preservers= Association* 58:79-86.
- Forsyth, P.G., J.J. Morrell and H. Chen. 1998. Rates of MITC release from Basamid applied to Douglas-fir poles. *Forest Products Journal* 48(2):40-43.
- Gordon, A. 1947. Chemonite- Its history and development. *Proceedings American Wood Preservers= Association* 43:278-285.
- Graham, R.D. 1983. Improving the performance of wood poles. *Proceedings American Wood Preservers= Association* 79:222-228.
- Hartford, W.H. 1996. A chemists view of the treatment of Douglas-fir with ACZA. *Proceedings American Wood Preservers= Association* 92:27-31.
- Matus, R. 2001. Wood Worries: could your home make you sick? *The Gainesville Sun* 125(253):Pages 1, 8A-9A.
- Morgan III, J. 1989. The evaluation and commercialization of a new wood preservative. *Proceedings American Wood Preservers= Association* 85:16-26.
- Morrell, J.J., C.S. Love, and H. Chen. 1998b. Field performance of controlled release chloropicrin. In: *Proceedings International Conference on Utility Line Structures*. Fort Collins, Colorado. Pages 129-138.
- Morrell, J.J. and M.E. Corden. 1986. Controlling wood deterioration with fumigant: a review. *Forest Products Journal* 36(10):26-34.
- Morrell, J.J. 1996. *Wood Pole Maintenance Manual: A guide to specification, inspection and maintenance*. Research Contribution 14, Forest Research Laboratory, Oregon State University, Corvallis, Oregon.
- Morrell, J.J., M.A. Newbill. And C.M. Sexton. 1992. Remedial treatment of Douglas-fir and southern pine poles with methylisothiocyanate. *Forest Products Journal* 42(10):47-54.



## ***OBJECTIVE II***

### **IDENTIFY CHEMICALS FOR PROTECTING EXPOSED WOOD SURFACES IN POLES**

---

Preservative treatment prior to installation provides an excellent barrier against fungal, insect, and marine borer attack, but this barrier only remains effective as long as it is intact. Deep checks that form after treatment, drilling holes after treatment for attachments such as guy wires, cutting poles to height after setting and heavy handling of poles that result in fractures or shelling between the treated and untreated zone can all expose untreated wood to possible biological attack. The Standards of the American Wood Preservers' Association currently recommend that all field damage to treated wood be supplementally protected with solutions of copper naphthenate. While this treatment will never be as good as the initial pressure treatment, it provides a thin barrier that can be effective above the ground. Despite their merits, these recommendations are often ignored by field crews who dislike the oily nature of the treatment and know that it is highly unlikely that anyone will later check to confirm that treatment has been properly applied.

In 1980, The Coop initiated a series of trials to assess the efficacy of various field treatments for protecting field drilled bolt holes, for protecting untreated western redcedar sapwood and for protecting untreated Douglas-fir timbers above the groundline. Many of these trials have been completed and have led to further tests to assess the levels of decay present in above ground zones of poles in this region and to develop more accelerated test methods for assessing chemical efficacy. Despite the length of time that this Objective has been underway, above ground decay and its prevention continues to be a problem facing many utilities as they find increasing restrictions on chemical usage. The problem of above ground decay facilitated by field drilling promises to grow in importance as utilities find a diverse array of entities operating under the energized phases of their poles with cable, telecommunications and other services that require field drilling for attachments. Developing effective, easily applied treatments for the damage done as these systems are attached can lead to substantial long term cost savings and is the primary focus of this objective.

#### **A. Evaluate Treatments for Protecting Field Drilled Bolt Holes**

The test to evaluate field drilled bolt holes was inspected in 2002 after 20 years of exposure. This test is largely completed, although some follow-up inspection to assess residual chemical levels around bolts in specific poles is planned.

#### **B. Develop Methods for Ensuring Compliance With Requirements for Protecting Field-Damage to Treated Wood.**

While most utility specifications call for supplemental treatment whenever a hole or cut penetrates beyond the depth of the original preservative treatment, it is virtually impossible to verify that a treatment has been applied without physically removing the bolt and inspecting the exposed surface. Most line personnel realize that this is highly unlikely to happen, providing little or no motivation for following the specification.

Given the low probability of specification compliance, it might be more fruitful to identify systems that ensure protection of field damage with little or no effort by line personnel. One possibility for this approach is to produce bolts and fasteners that already contain the treatment on the threaded surface. Once the "treated" bolt is installed, natural moisture in the wood will help release the chemicals so that they can be present to inhibit the germination of spores or growth of hyphal fragments of any invading decay fungi.

The potential for these treatments was evaluated using both field and laboratory tests. In the initial laboratory tests, bolts were coated with either copper naphthenate (Cop-R-Nap) or copper naphthenate plus boron (CuRap 20) pastes and installed in Douglas-fir pole sections which were stored for one or two weeks at 32 C. The poles were then split through the bolt hole and the degree of chemical movement was assessed using specific chemical indicators. Penetration was measured as average distance up or down from the bolt.

Penetration of copper from bolts coated with only copper naphthenate was 2 mm one week after treatment and not detectable after 2 weeks of exposure (Table II-1). These results suggest that the copper was largely unable to move from the threaded rod into the wood. While limited movement might not pose a problem if the preservative created a sufficient barrier around the surface of the bolt hole, small checks or cracks could easily compromise this barrier. The inability of the copper to move into these cracks would largely negate the benefits of treatment. The inability to move with moisture into freshly opened checks also appeared to be one of the primary causes of failure for topically applied bolt hole treatments such as the pentachlorophenol in diesel oil treatment used in the original bolt hole test in Objective IIA of this report.

Bolts treated with the copper/boron paste also had minimal copper penetration 1 week after treatment, but the depth of penetration increased markedly with a second week of exposure. Boron distribution proved more variable. Initially, boron movement appeared to be substantial, but samples exposed for 2 weeks tended to have much shallower boron penetration. These results suggest that measurement errors influenced the initial results. The boron indicator is very sensitive and even small amounts of boron inadvertently smeared across the wood surface could lead to a positive result.

The preliminary tests suggested that the presence of a water diffusible component in the paste would be useful for providing deeper protection to the field damaged wood. For this reason, we established the subsequent field trial.

Table II-1. Degree of longitudinal penetration of copper or boron from rods coated with preservative paste and installed in Douglas-fir poles for one or two weeks.

Treatment	Exposure Period (weeks)	Chemical Penetration (mm)			
		Copper		Boron	
		Upward	Downward	Upward	Downward
Cop-R-Nap	1	2	2	-	-
	2	0	0	-	-
CuRap 20	1	2	2	36	42
	2	7	10	6	5

Galvanized rods (300 mm long by 12.7 mm in diameter) were coated along the center 200 mm with a layer of either 5 g of Cop-R-Plastic (copper/fluoride) or 3 g of CuRap 20 (copper/boron) (oven dry basis). The rods were oven dried (54 C), and then painted with 2 coats of Plastidip (Figure II-1). One rod from each treatment was applied to each of 26 pentachlorophenol treated Douglas-fir poles sections that were exposed at the Peavy Arboretum test site. Selected poles were removed from the field one, two or three years after treatment and split lengthwise around the bolt hole. The average and maximum degree of diffusion of the each paste components was measured after the wood had been sprayed with the appropriate chemical indicator.



Figure II-1. Examples of galvanized rods coated with copper/boron (CuRap20) and copper/fluoride (Cop-R-Plastic) pastes.

The average degree of copper penetration away from the rods continues to be small, ranging from less than 1 mm to 4 mm, although the maximum penetration of copper approached 300 mm in some samples (Table II-2). Maximum copper penetration tended to be greater in the Cu/F system than in the Cu/B system for the first two years, however, these differences have disappeared after three years. Maximum distance may reflect the ability of the liquid to move for long distances in the wood along openings such as checks or splits. At this point, there appears to be little difference in movement between the two copper naphthenate systems, one of which is oilborne and the other an amine-based waterborne system.

Table II-2. Degree of copper, boron, or fluoride diffusion from galvanized rods one to three years after installation in creosote-treated Douglas-fir pole sections.

Treatment	Degree of chemical movement (mm) <sup>a</sup>											
	Copper						Boron/Fluoride					
	Average Diffusion			Average Maximum			Average Diffusion			Average Maximum		
	Year 1	Year 2	Year 3	Year 1	Year 2	Year 3	Year 1	Year 2	Year 3	Year 1	Year 2	Year 3
Cop-R-Plastic	<1	2.3 (1.3)	3.0 (0.8)	30 (29)	238 (64)	51 (48)	<1	2.0 (2.8)	2.0 (1.8)	118 (139)	108 (74)	15 (17)
CuRap 20	3.0 (1.0)	2.3 (0.5)	<1	21 (10)	110 (98)	51 (53)	3.3 (0.5)	6.3 (3.4)	2.8 (2.2)	50 (11)	46 (29)	50 (55)

<sup>a</sup> Values represent means, while figures in parentheses represent 1 standard deviation.



Average boron and fluoride diffusion were also somewhat limited 1 year after treatment. The degree of movement increased in the second year, but then failed to increase in the third year (Table II-2, Figures II-2,3). We suspect that the continued slow rate of diffusion might reflect, in part, the presence of the spray-on plastic coating, which was applied to protect the chemical prior to application. The pastes tended to dry after application to the rods and were prone to flaking during handling. The plastic coating was designed to limit flaking and we presumed that this coating would be disrupted as the rod was driven into the hole allowing the chemicals to interact with moisture in the poles. We also presumed that the coating would decompose in the presence of the oil. It is unclear if this, in fact, occurred, but the application of only one coat or the use of other less robust coatings might be prudent.



Figure II-2 Degree of a) copper [blue color] and b) fluoride [yellow color] movement away from the sites in Douglas-fir poles where Cop-R-Plastic coated galvanized rods were installed three years earlier.

The results show that the coated rods can deliver chemicals to a small area around the treatment hole. These results, coupled with previous trials of boron and fluoride sprays into field drilled bolt holes, suggest that treated bolts may represent one method for ensuring that field drilled wood is protected. This approach would allow utilities to specify specific treated bolts when other utilities occupy portions of the pole and must field drill for attachments. This approach would allow utilities to minimize the risk of decay in field drilled holes above the ground. As utilities continue to use



Figure II-3 Degree of a) copper [blue color] and b) boron [red color] movement away from the sites in Douglas-fir poles where CuRap 20 coated galvanized rods were installed three years earlier.

internal and external treatments to protect the groundline zone, slow development of decay above the ground may threaten the long term gains provided by groundline treatments. This type of treatment could be used to limit the potential for above ground decay, allowing utilities to continue to gain the benefits afforded by aggressive groundline maintenance.

### **C. Ability of Topical Treatments to Limit Decay of Untreated Douglas-fir Timbers**

Although not directly related to utility poles, we have also evaluated the ability of various surface treatments to protect untreated Douglas-fir from decay. The results of these tests can be directly related to the ability of these same chemicals to protect untreated wood exposed either through cutting or drilling.

Five simulated piers were constructed to create various end-grain and butt joints that would serve as water collecting points and encourage fungal attack. Each pier was supported by nine creosoted Douglas-fir piles that were equally spaced in a 3.6 m square area. A 50 by 300 mm by 2.1 m long plank was placed across each of three groups of piles to provide support for the caps. Each pier was constructed with 8 pairs of abutting 250 mm by 250 mm by 2.1 m long

caps, 10 pairs of abutting 100 mm by 250 mm by 2.1 m long stringers and 8 trios of abutting 100 mm by 250 mm by 1.6 m long deck planks (Figure II-4). A kerf was sawn to the center of the timber along the length of one face of each of eight caps. The kerfs were oriented downward in the piers to prevent water collection. The remaining eight caps were not kerfed.



Figure II-4. A simulated pier structure 25 years after construction

The five structures were used to evaluate nine different wood treatment combinations and roofing felt (Table II-3). Each treatment was applied to the upper surfaces of the caps, stringers and deck planks of one half of a structure. The remaining untreated deck served as a control. Each treatment was evaluated on 4 caps, 10 stringers, and 12 abutting deck planks. The decking, laid over roofing felt, received 3.5 liters of fluor-chrome-arsenic-phenol (FCAP), ammonium bifluoride (ABF) or disodium octaborate tetrahydrate (DOT) applied by spraying the upper surface and any seasoning checks or butt joints, approximately 2 years after installation.

Treatment	Carrier	Concentration (%)
Pentachlorophenol (penta)	Oil	10
Copper-8-quinolinolate	Oil	1 (Cu basis)
Fluor-Chrome-Arsenic-Phenol (FCAP)	Water	12
Ammonium bifluoride (ABF)	Water	20
Disodiumoctaborate tetrahydrate (DOT)	Water	9
FCAP-flooded felt <sup>a</sup>	Water	2
ABF-flooded felt	Water	20
DOT-flooded felt	Water	9
Roofing felt alone	-	-

<sup>a</sup> Felt was applied beneath stringers and decking planks

Resistance to fungal attack was assessed by removing increment cores from various locations and placing them on 1 % malt extract agar in petri dishes. The plates were observed for one month and any fungal growth was examined for characteristics typical of basidiomycetes, a class of fungi containing many important wood decayers. Two cores were removed from the underside of each cap adjacent to the creosote support. Four cores were removed from every fourth stringer, so that a stringer was sampled every fourth sampling time. Two of these cores were removed from directly under the overlaying deck plank, while the other two were removed from sites near the stringer/cap junction. The deck planks were sampled at the junction of abutting boards, at the mid-span between stringers and at the deck/stringer junction.



Levels of fungal isolations in caps without treatment gradually increased over time (Figure II-5). Initially, caps with kerfs tended to have lower levels of colonization, but this effect appeared to decline over time. Kerfing has been found to be especially effective at limiting internal decay in utility poles, but these poles also have a deeper preservative barrier. Kerfing untreated wood appears to have a reduced protective effect, probably because of the potential for fungal attack in smaller checks that can still develop on the upper surfaces of the kerfed timbers. Initial treatments with FCAP or ABF both limited fungal attack over time for both kerfed and non-kerfed caps with or without roofing felt. Both of these chemicals are capable of diffusion as checks open. Chemical effectiveness was enhanced when the treatments were applied in combination with roofing felt, which provided a reservoir of chemical and probably limited moisture uptake in the critical joint area. DOT appeared to have a limited protective effect, a finding that differs from previous tests on field drilled bolt holes. The reasons for this more limited protection are unclear, but they may reflect the higher leaching risk in the caps in comparison with the more protected bolt holes. DOT with roofing felt performed much better than without the felt. Initial applications of penta and Cu-8 both had limited effects on fungal isolations in comparison to the untreated control. Both of these chemicals are oil-borne and have limited potential to migrate into the wood. As a result, they are largely unable to move into the wood as seasoning checks open over time. Decay fungi landing in these unprotected checks can circumvent the surface protection afforded by these treatments.

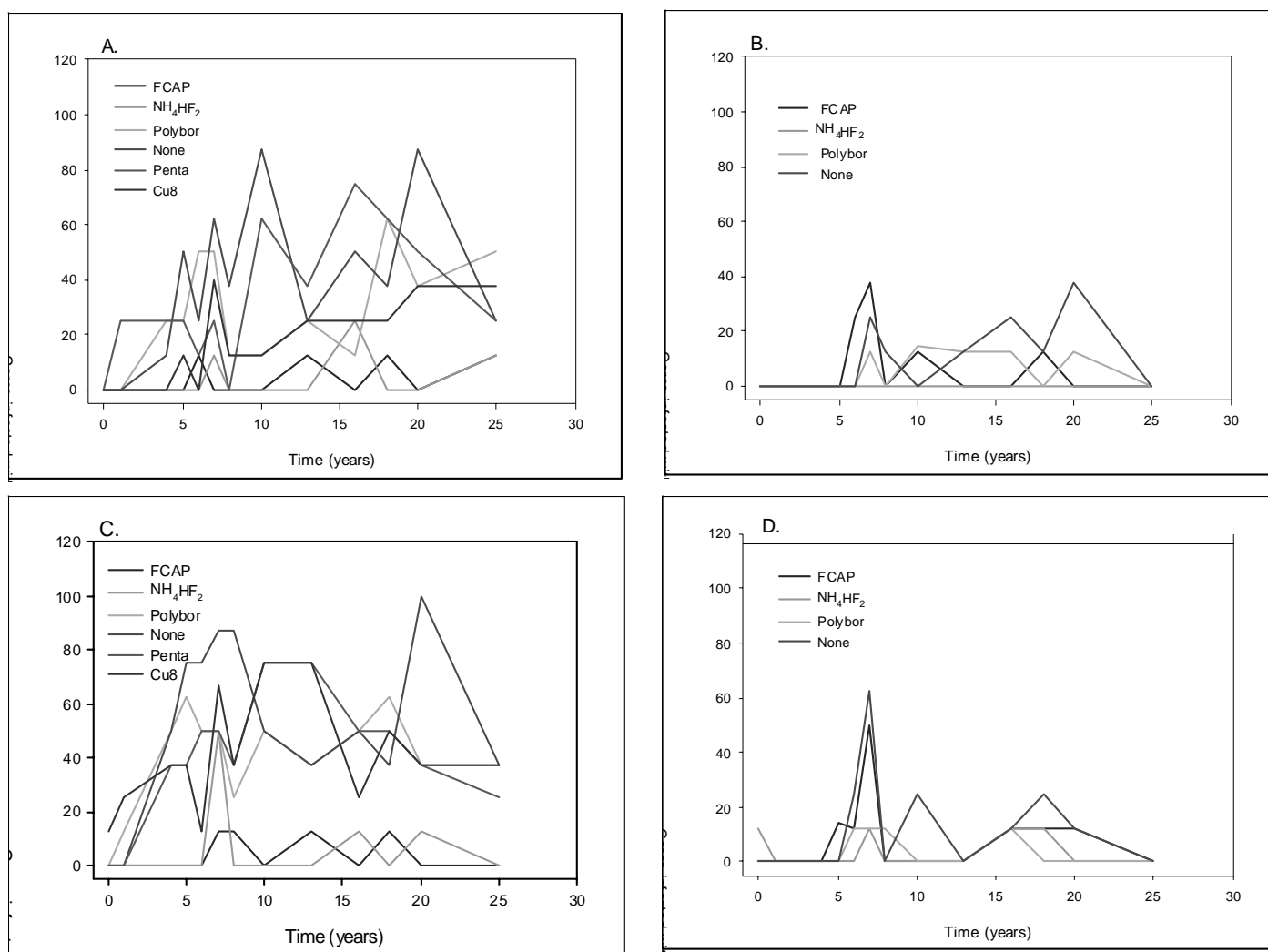

Figure II-5. Effect of selected fungicides on levels of fungal isolation from Douglas-fir caps with (a, b) or without kerfing (c, d) and with (b, d) or without (a, c) roofing felt between the caps and the stringers as measured over a 25 year period.

The use of roofing felt between wood connections produced a similar enhancing effect on chemical performance for stringers, but did not appear to enhance protection of the untreated controls (Figure II-6). In addition, there appeared to be less difference in fungal isolations between the various treatments than was found in the larger caps. The lack of differences may reflect the limited depth of checking on these smaller members. Smaller checks increase the likelihood that a sufficient quantity of chemical can migrate from the surface into the shallower checks. In addition, smaller timbers are likely to dry more quickly, reducing the overall risk of fungal colonization. This effect is supported by the lower overall levels of fungal colonization on the stringers in comparison with the caps.

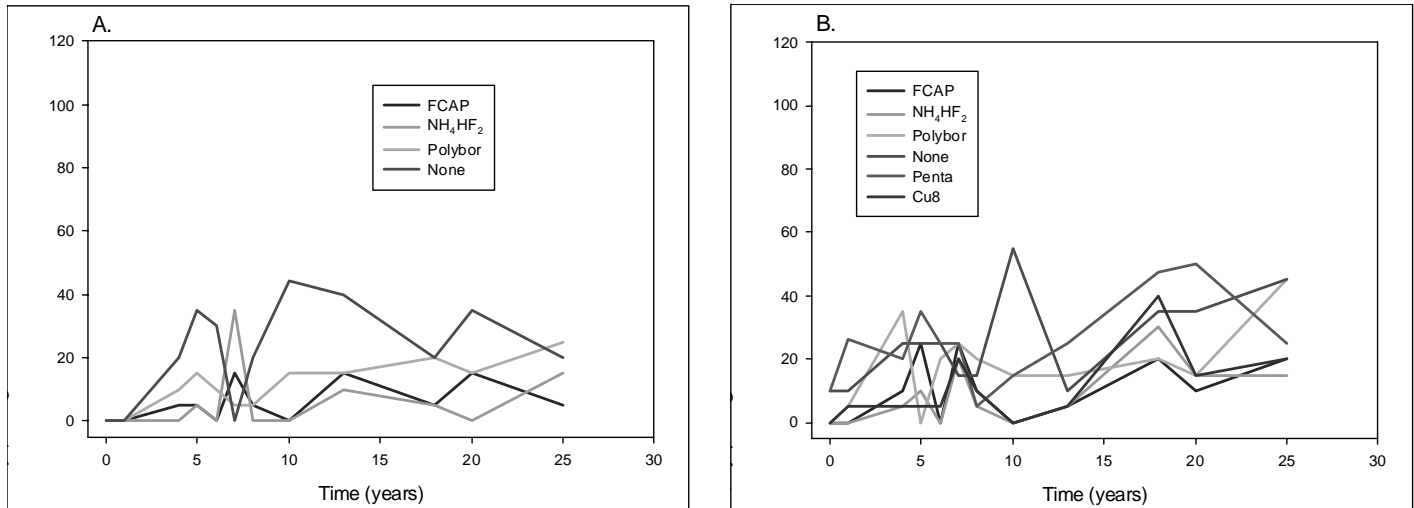

Figure II-6. Effect of surface applications of various fungicides to Douglas-fir stringers with (a) or without (b) roofing felt on fungal isolations 1 to 25 years after treatment.

Fungal isolations from the deck planks tended to be lower on the FCAP and ABF treatments than for the remaining treatments (Figure II-7). Roofing felt appeared to enhance ABF and FCAP performance slightly, suggesting that the felt limited fluoride losses and provided a reservoir for replenishing the treatment over time. The protection afforded by DOT was, once again, much lower, despite the water solubility of this system. The decks would clearly be exposed to the highest leaching exposure of the three members tested, increasing the likelihood that any surface boron could leach from the wood over time. Colonization of decking treated with one of the two oil-soluble systems (Penta and Cu-8) provided more variable protection that did not differ markedly from the control. These results suggest that less mobile treatments provide relatively little protection and confirm previous trials in field drilled bolt holes.

The results highlight the benefits of topical applications of water diffusible treatments, particularly fluoride, to otherwise unprotected wood. We would expect similar results for untreated wood exposed in pressure treated poles.

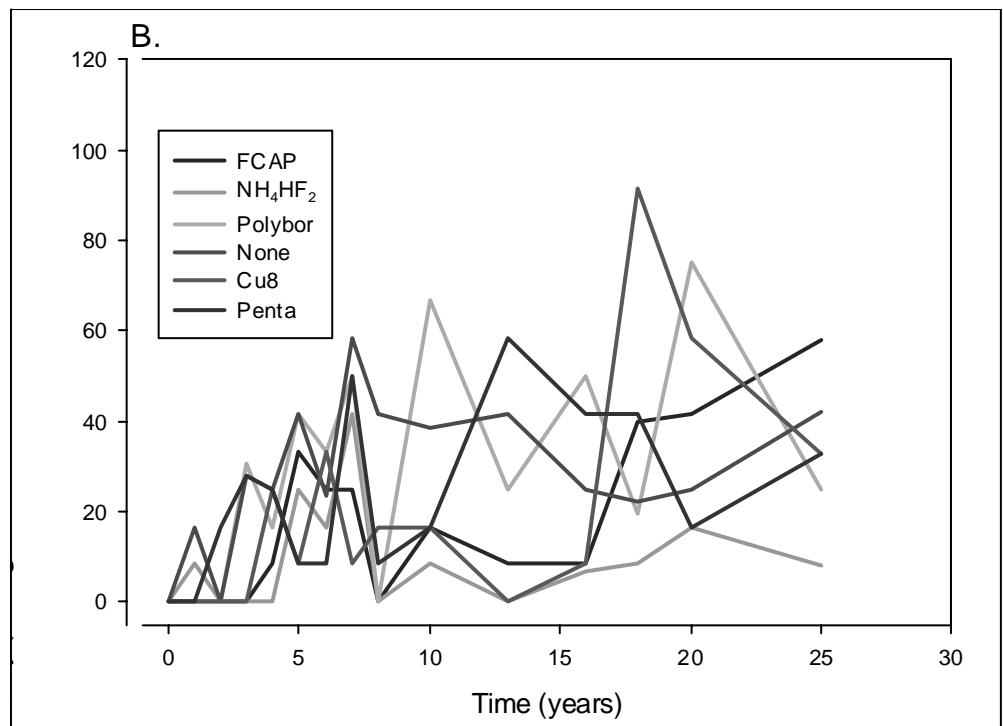
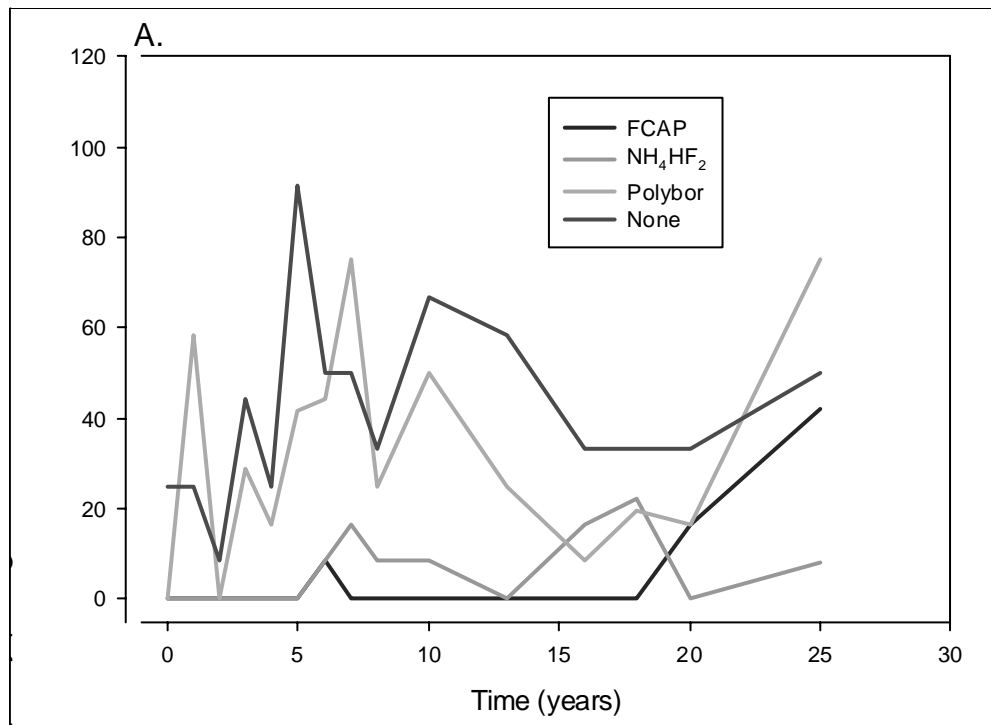

Figure II-7. Effect of surface applications of various fungicides to Douglas-fir decking planks with (a) or without (b) roofing felt on fungal isolations 1 to 25 years after treatment.



*Objective III*

**EVALUATE PROPERTIES AND DEVELOP IMPROVED  
SPECIFICATIONS FOR WOOD POLES**

---

A well treated pole will provide exceptional performance under most conditions, but even a properly treated structure can experience decay in service. While most of our efforts have concentrated on developing systems for arresting in-service decay, developing methods for preventing this damage would produce even greater investment savings for utilities. The goals of Objective III are to develop new treatment methods, explore the potential for new species, assess various inspection tools and explore methods for producing more durable wood poles.

**A. EFFECTS OF THROUGH BORING AND RADIAL DRILLING ON POLE STRENGTH  
PROPERTIES (this section represents the preliminary proposal of Lori Elkins)**

The use of either through boring or radial drilling in the groundline region of Douglas-fir poles largely eliminates the potential for fungal attack in this zone and is a major contributor to the excellent pole service lives being observed in many regions of the country (Figure III-1). Over the past 10 years, we have performed a number of studies examining the degree of preservative penetration in the through bored region of poles and found that poles with greater than 70 % preservative penetration in the through bored zone were free of decay. Based upon this work, we also examined the potential for using more widely spaced patterns to reduce the amount of wood removed from any given cross section and these data were used, in part, to increase hole spacing in poles specified by Bonneville Power Administration, Portland General Electric and PacifiCorp. In addition to this work, we examined the effects of full length through boring on pole bending properties and found that the process caused approximately a 10 % reduction in modulus of elasticity or modulus of rupture. The number of poles tested, however, was relatively small.

The question of how much strength is lost when a pole is through bored has long troubled engineers who object to the loss of any wood fiber. There is no question that through boring or radial drilling remove some wood in the critical bending zones that could affect pole wood strength, but the loss of wood is considered to be offset by the subsequent high degree of protection against fungal attack in this zone. As a result, these groundline boring processes have long been viewed as giving up some initial strength to provide more uniform pole performance. The body of data supporting either through boring or radial drilling is rather limited. Both strategies were developed in the 1960's in response to severe early failures of Douglas-fir poles due to internal decay. Two through boring patterns and one radial drilling pattern emerged from a series of utility tests involved relatively few full length poles. While no significant effects on bending strength were observed and the poles all broke above the drilled zone at their predicted bending moment, the overall number of poles tested for each of the processes remains low. Conversely, through-boring and radial drilling have been used to protect the groundline zone of millions of Douglas-fir poles with little or no evidence that the process produces weaker poles.





The previously employed BPA pattern resulted in the largest loss in section modulus of the 4 patterns examined (Table III-1). Section modulus was reduced over 10 % in this pattern. This loss of section occurred because, over the years, the treater had substituted larger drill bits for the process. While this reduced drifting of bits during drilling and undoubtedly reduce breakage, it also increased the possible effects of the process on section modulus. The results of this calculation (performed by Scott Kent, an OSU Graduate Student) led to changes in BPA specifications. The new pattern using smaller bits has a slightly lower reduction in section modulus. Spreading the pattern even further such as the widely spaced pattern used in full length through bored poles tested in cooperation with BPA, PGE and PacifiCorp, only produced 4 to 4.5 % loss in section modulus.

In all instances examining through boring, the loss in section was directional since the through boring holes are only applied on one side of the pole. As a result, section modulus reductions tended to be slightly lower perpendicular to the through boring direction. One outcome of these findings, which were confirmed by previous tests on through bored lodgepole pine, is the need to alternate poles to avoid a directional effect in the line. This is relatively simple to accomplish for BPA, since all poles are through bored in the cross arm zone so they can be field drilled, however, it becomes more problematic for utilities that use pre-boring for attachments (a highly recommended practice) since the treater must alternate through boring and pre-drilling patterns to create poles where these holes line up and where they are 90 degrees around from one another. This may not be feasible on a field basis and it will be important to determine if the 2 % gain in section modulus is really worthwhile given the wide variations in wood properties and the safety factors that are already applied to poles.

Boring pattern	Axis	Calculated Section Modulus (in <sup>3</sup> )	Reduction (%)
None	X-X	402	-
	Y-Y	402	-
Original BPA	X-X	328	10.4
	Y-Y	336	8.2
New BPA	X-X	372	7.5
	Y-Y	381	5.2
Simplified Radial	X-X	379	5.8
	Y-Y	379	5.8
Newbill Pattern	X-X	386	4
	Y-Y	384	4.5

<sup>A</sup> Values based upon a pole 15.5 inches in diameter at groundline for the old BPA pattern and 16 inches for all others. Newbill pattern is from full length through bored poles.

---

Calculations of section modulus loss applied to radial drilled poles using 4 inch long holes every 45 degrees around the poles (i.e. 8 holes around the pole in a given cross section) showed that section loses were 5.8 % in comparison with the non-bored pole. These values are slightly greater than those found with the Newbill pattern, but lower than those found with either BPA pattern. The radial drilling effect is uniform around the poles, reflecting the presence of holes on all faces.

### *OBJECTIVES*

The objectives of the research project are related to hole size, potential hole interaction, and the effect of holes on pole strength. Three specific objectives are:

1. To find a bore (hole) size that is optimal in terms of material removed and stress concentrations created due to geometry.
2. To create a spacing pattern that achieves adequate preservative penetration yet minimizes stress interactions.
3. To determine the strongest direction of loading of the poles with respect to the direction of the through-bored holes.

### *BACKGROUND*

In 2003, Kent examined the strength effect of through boring by conducting a static analysis of through bored poles based strictly on section removal. The results showed a strength loss of 8% up to 23% depending on interaction between layers of holes and loading direction. The worst case was assumed to be where holes within 6 in. of each other along the longitudinal axis acted on the same plane, and the best case was assumed to be a single layer of holes with no interaction with holes on another plane. He also found that the reduced section on a plane would have a greater effect if the poles were loaded parallel to the axis of the holes than perpendicular to the hole axis. The present study sought to delve deeper into the effects of through boring by using more advanced computational methods; specifically, examining the effect of stress concentration factors through finite element analysis.

Effects of stress concentration on failure are predicted by elastic stress concentration factors (SCF) (Wu and Hu 2003). A literature review of SCF attributable to holes showed that for the case of a solid shaft, the SCF is a function of hole diameter, as well as shaft diameter. Specifically, for round members with diametral holes under bending stresses, at first, SCFs decrease with decreasing hole diameter to some critical, very small diameter hole, but then the stress concentrations increase as the hole size is reduced further (Pilkey 1994). This trend accounts for both the material being removed and the stress concentration due to geometry.

Poles exhibit variations in their strength properties due to growth features such as knots, spiral grain, and proportions of juvenile wood to mature wood. The effects of such growth characteristics were beyond the scope of the current research and were not modeled in this analysis. Pellicane and Franco (1994) have developed a three-dimensional finite-element pole model that incorporated these features.

#### **Hole Size**

Using the empirical formula generated by Pilkey, for a class 4, 40-ft. pole the optimum hole size range is 3/4 in. to 1-1/8 in. (Fig III-2). This assumes a fixed pole diameter of 10.66 in., which is the minimum groundline diameter for this class as specified by ANSI (1992). The groundline is approximately the average diameter of the bored section and the difference in taper across the region had a minimal effect on optimal hole size.

This same behavior is not seen in cylinders under other types of loading. In the case of tensile loads, the SCFs follow the more predictable trend of increasing with increasing bore diameter (Wu and Mu 2003). However, the SCF for a diametrical hole in a shaft subjected to torsion is higher than those for bending or tension (Jessop et al. 1958).

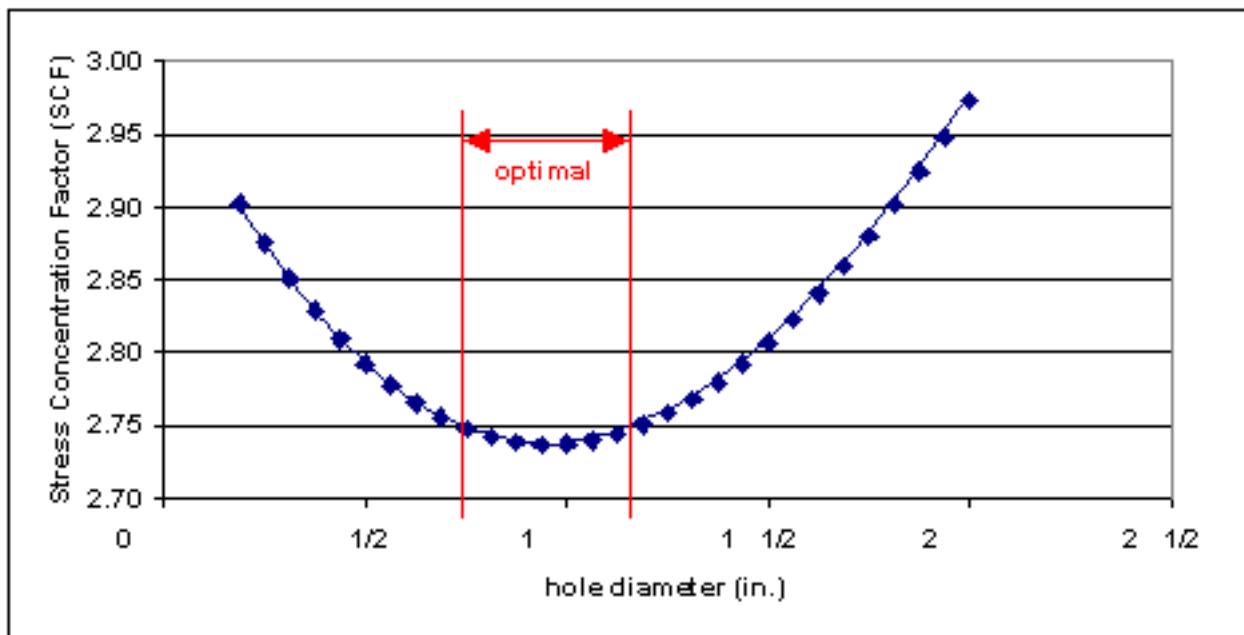

Figure III-2. Distribution of stress concentration factor in a 40 ft., Class 4 utility pole as a function of diameter of bore hole. The pole diameter of 10.66 in. was assumed constant for purposes of calculation.

The analytical solution from Pilkey (1994) that poles under bending stresses have a characteristic “dip” in the SCF is supported by the outcome from previous pole tests. Portland General Electric’s tests from 1961 found that two pole groups drilled with 1/4 in. holes, “showed consistently lower strengths than any of the poles bored with the 7/16 in. holes.” The report stated that the reason for this result was “obscure” but observed that fewer, larger holes in wood appeared better able to withstand stresses than the more numerous smaller holes.

### Hole Spacing

When designing an optimal bore pattern, the first factor to consider is preservative penetration. Research conducted by the Utility Pole Research Cooperative at Oregon State University found that creosote preservative penetration averaged 8.5 in. longitudinally ( $\pm 3.8$  in.) and 0.72 in. transversely ( $\pm 0.16$  in.) (1998). Using a conservative estimate of these values suggests that a longitudinal and transverse spacing of 5 in. and 1.5 in., respectively, would provide the necessary coverage (Fig. III-3).

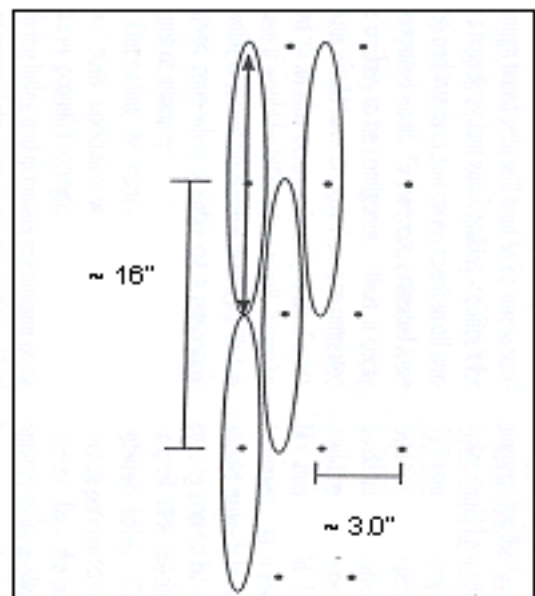

Figure III-3. Average preservative penetration based on Utility Pole Research Cooperative (1998).

The existing literature by Pilkey on the effect of unloaded, aligned, holes is limited to holes in plates and does not address cylinders. However, the research showed that for longitudinal spacing of the holes in a plate, in a two-hole configuration, the stress concentration continually increased up to a separation distance of about 10 hole radii ( $10a$ ). Then the holes were spaced far enough apart to act independently and the SCF was the same as for one hole. Thus, the SCFs for longitudinally spaced holes are never greater than the SCF for one hole when the longitudinal spacing is at least  $10a$ . For transverse hole spacing, the plate research shows that for aligned holes, a spacing equal to  $6a$  is the critical spacing where the SCF of the two holes will interact at spacings less than  $6a$ . The interaction of the two holes causes a stress reduction while holes spaced greater than a distance of  $6a$  will behave more like a single hole.

Falk et al. (2003) found that hole location may be as critical a factor as hole size when comparing bending stresses around holes in large dimensional lumber. Specifically, it is important to keep holes out of highly stressed regions.

### **Load direction**

Intuitively, poles will exhibit lower stresses if the loading is applied perpendicular to the axis of the bore holes and this is reflected in construction practice today. Jessop et al. (1959) found “much lower” SCFs for cylinders with holes under bending stress when the load was applied in a plane perpendicular to the axis of the bore hole.

## *BASIC MODELS*

### **Global Pole Model**

The research optimizing a standard through boring pattern began with finite element modeling the entire utility pole. The pole model was a 40-ft., Class 4, tapered cantilever pole with groundline and tip diameters equal to 11.55 in. and 7.5 in., respectively. The pole was modeled with typical Coastal Douglas-fir, linear, elastic, orthotropic material properties (USDA 1999).

The global coordinate system is X and Y as orthogonal diameters across the grain and Z is the longitudinal axis of the pole. The radial and tangential material properties were averaged and set equal so only two distinct directional elastic properties were entered, parallel and perpendicular to the grain. Solid elements were used to represent the volume, with a 1-kip load applied 2 ft. below the tip and the lower 6 ft. of the model was fixed from translation. The model output was compared against predicted stresses for verification. Figure III-4 shows the element stress solution; the range of non-peak stresses was within 10-15% of predicted stresses for a fixed cantilever at the groundline, and the maximum and minimum stress occurred, as predicted, at the top of the restricting boundary conditions (the groundline). Thus, the model was accepted.

Figure III-4. The three-dimensional, global, cantilever pole model with 1-kip test load applied 2 ft. from tip and bottom 6 ft. restrained from translation in all directions.

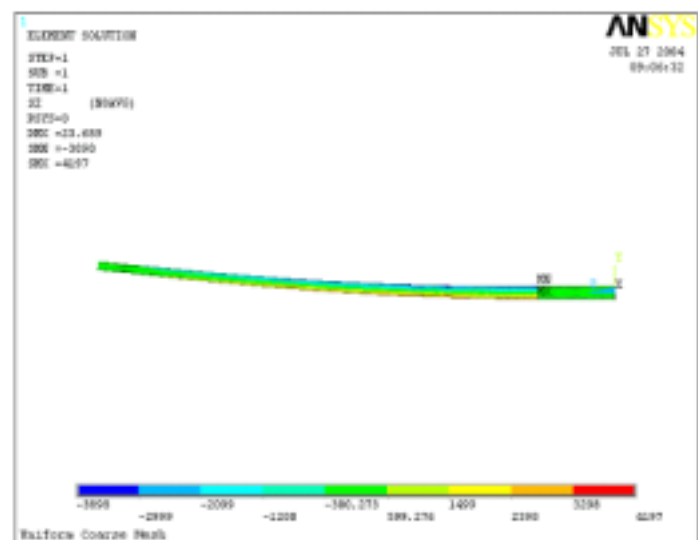

Next, the model was intended to run with the borings removed from the pole above and below the groundline. However, the complex geometry created by the addition of the borings made numerical convergence difficult to impossible. Once a solution with the borings was obtained, it was not sufficiently refined to ascertain the detailed, peak stresses, which are of primary importance in this research. Attempts to further simplify the geometry, such as removing the section of pole below ground, did not adequately reduce the problem.

### **Stump Submodel**

Submodeling was employed to examine the detailed stress effects around the borings. Most of the work was done on a 2 ft., tapered section of the pole, representative of the global pole at the groundline ( $\varnothing_{\text{top}} = 5.50$  in.,  $\varnothing_{\text{bottom}} = 5.74$  in.). The stump submodel is shown in Fig. III-5. Nodal translations are fixed at the groundline. The effect of the fixed boundary condition was that the stump submodel could not translate as a rigid body or rotate at the base. The magnitude of stress in the full-size pole under the 1-kip test load was applied to the stump submodel by applying a displacement to the free end.

The loading of the submodel was accomplished by imposing a displacement on the other, free end of the stump. This was a more efficient computational approach as it did not produce any false, peak stresses that are common around point loads and it adequately represented the section of the pole subjected to mechanical forces

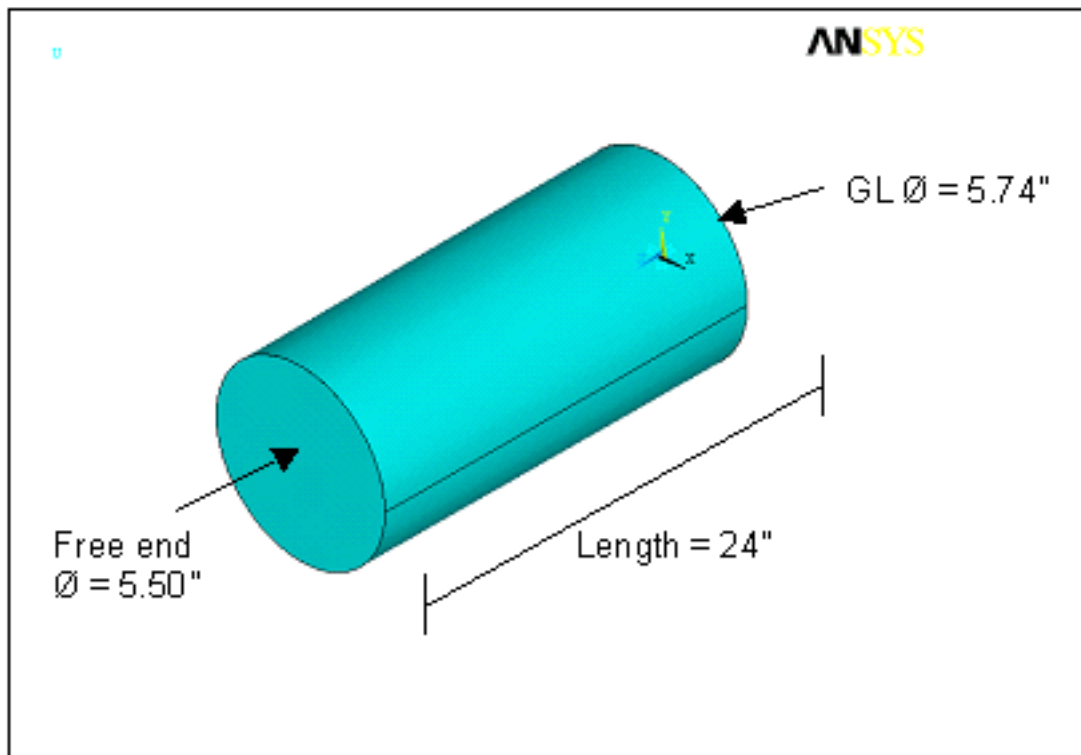

Figure III-5. Stump submodel represents the pole from groundline to 24 in. above the groundline.

## PARAMETER ASSESSMENT

### Hole Size

Eq. (1)

Finite-element analysis was used to model the effect of hole size on peak SCF. SCF is defined, for purposes of this analysis, as the maximum peak stress in or around the hole ( $\sigma_{PEAK}$ ), divided by the nominal stress at the same location

without the hole present ( $\sigma_{NOM}$ ):

$$SCF = \frac{\sigma_{PEAK}}{\sigma_{NOM}}$$

One hole was placed in the center of the stump, 12 in. from the groundline, and aligned with the Y-axis. Bending stresses were created by applying displacement separately in the stump, either parallel or perpendicular to the axis of the bore holes. Displacement applied parallel to the hole axis (FY), produced maximum stress in the center outer edge, parallel to the Y-axis, so the hole was positioned in the peak stress region in the transverse center of the pole (Fig. III-6). For loading perpendicular to the hole axis (FX), the center of the pole where the last hole was positioned is now the lowest stressed region in the pole with the peak stress occurring on the outer edges along the X-axis. As a result, the hole was offset approximately 2 in. to position the hole in the higher stress region and produce a peak stress at the hole instead of the groundline to adequately investigate the impact of the hole size.

The hole size was then varied in the model in 1/4 in. increments, from 1/4 in. up to 1-1/4 in. to evaluate its effect. All other conditions were kept as uniform as possible. The offset in the X-direction was adjusted for each hole size, so that the edge of the hole was consistently the same distance from the edge of the pole. This was done to minimize the effect of edge distance on the peak stress.

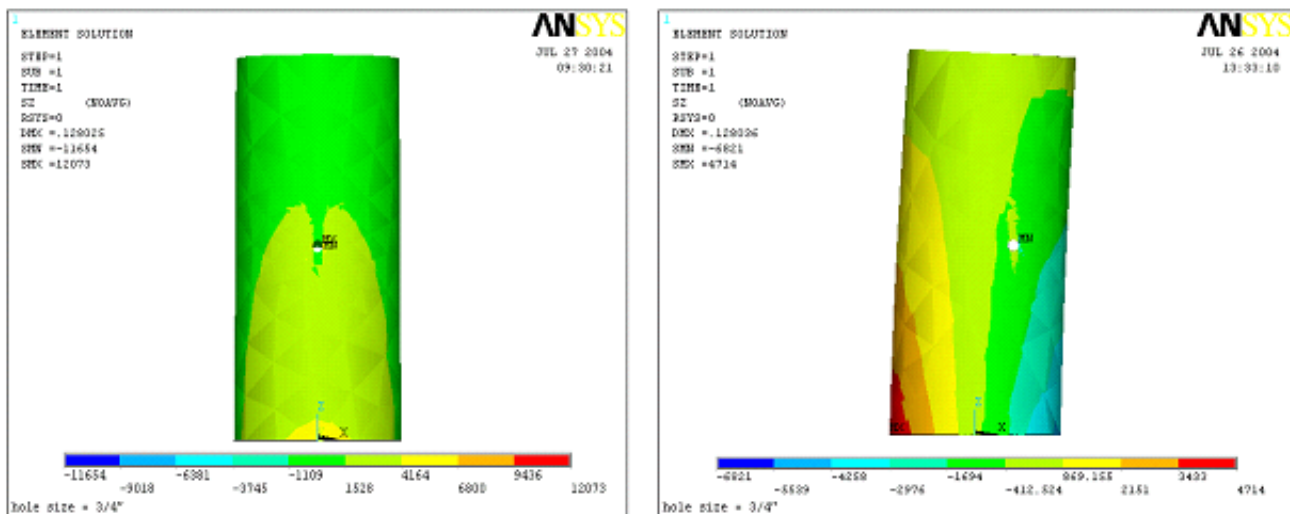

Figure III-6. Hole size models for loading in the Y-direction, parallel to the hole (FY) (shown left) and X-direction, perpendicular to the hole (shown right) as viewed in the X-Z plane.



Meshes around the varying hole sizes were difficult to consistently maintain and this made the stress analysis output for hole size somewhat inconsistent. As the hole size was changed in the model, the mesh around the hole changed also. Smaller diameter holes had a “tighter”, more refined mesh than the larger diameter holes. The finer meshes influenced the magnitude of the peak stress concentrations; typically, showing higher peak stresses. To address this, attempts were made to converge models with added refinement until a stable stress solution was reached but this was beyond the software capabilities. Alternatively, two model runs were used; one, where the mesh refinement was held constant, and the second, where refinement was increased in the areas of larger holes. Both results are presented in Figures III-7 and 8 and the two different refinements produce very similar stress outputs suggesting the refinement of the inside area of the holes is not a key factor in determining the peak stresses. Maximum tension stress is not shown for the FX loading case as the peak stress occurred at the groundline and was not pertinent for our analysis.

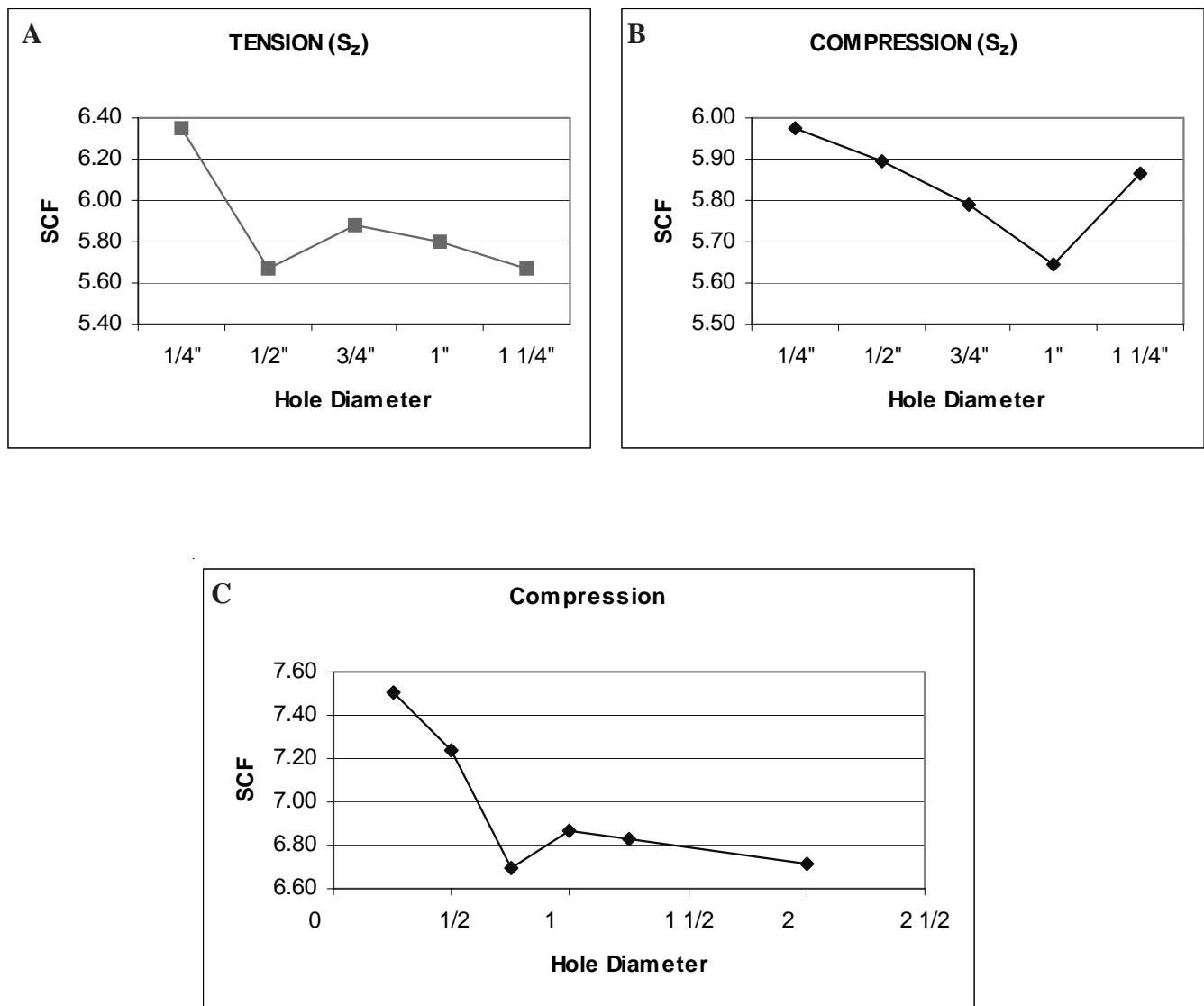

Figure III-7. SCF for bending stress ( $S_z$ ) as a function of hole size. INCREASING mesh refinement in area of holes. Loading is parallel to hole axis (FY) in (a) and (b). Loading is perpendicular to hole axis (FX) in (c).



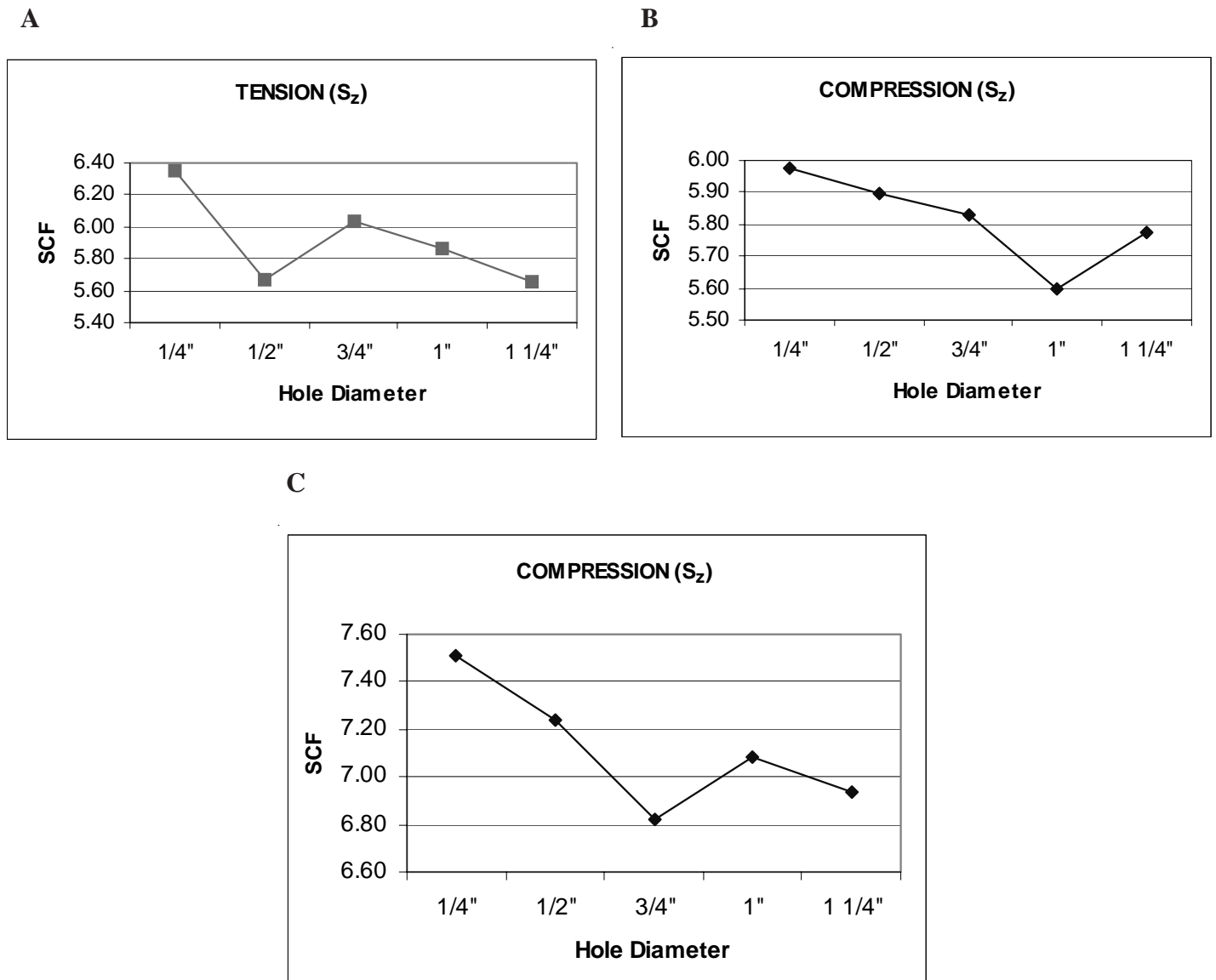

Figure III-8. SCF for bending stress ( $S_z$ ) as a function of hole size. UNIFORM mesh refinement in area of holes. Loading is parallel to hole axis (FY) in (a) and (b). Loading is perpendicular to hole axis (FX) in (c).

It is unreasonable to try to confirm model results experimentally by measuring stresses with strain gages, etc. as peak stresses in the model were consistently found inside the bore hole area (Figure III-9). This finding was consistent with the literature, confirming the adequacy of the submodel results (Jessop et al. 1958, EDSU 1989, and Thum and Kirmser 1943, cited in Pilkey 1994). The interior location of the peak stress was also the reason for mesh refinement being added to the inside areas of the hole in the models as opposed to around the exterior of the hole.

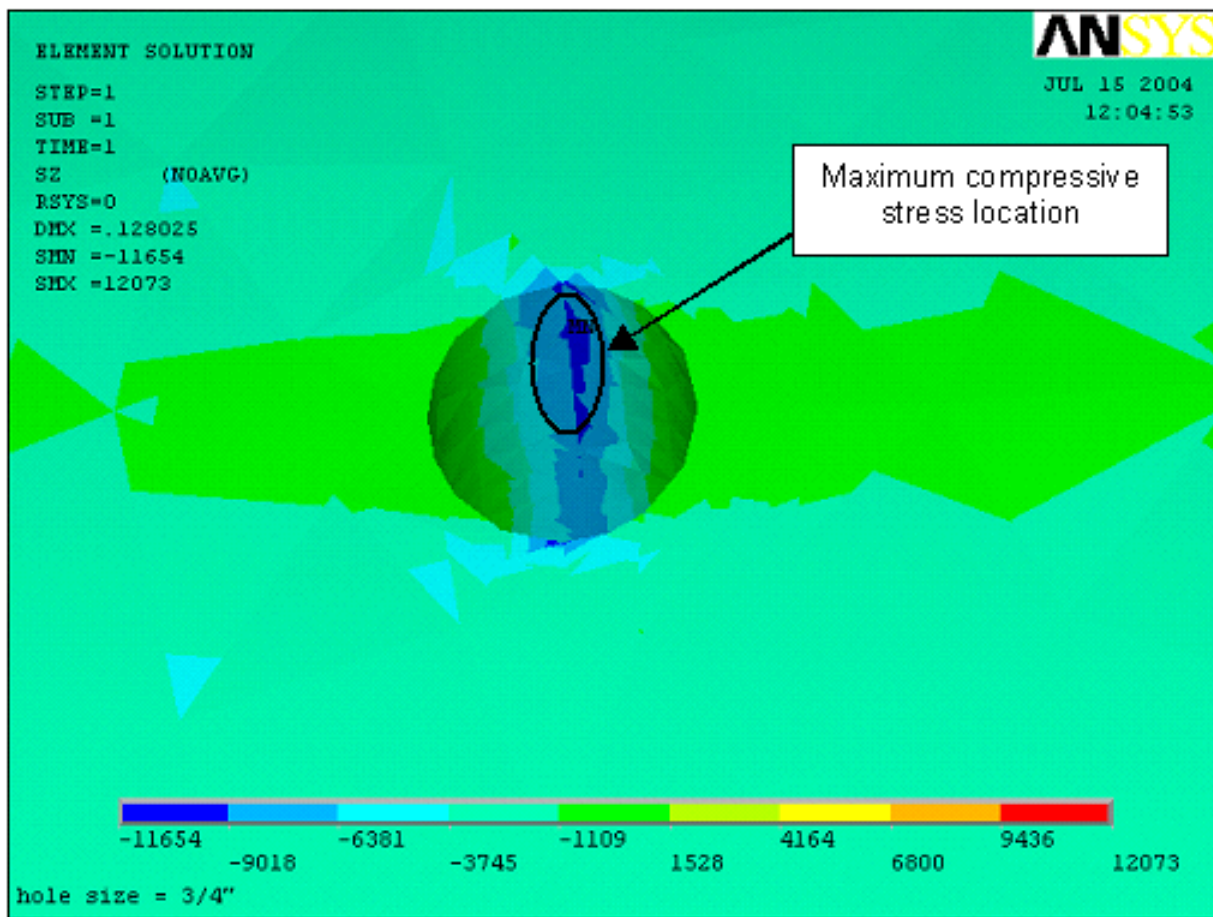

Figure III-9. Peak bending stress occurred in the interior of bore hole when loaded in the X and Y-directions

### **Hole Spacing**

Using finite-element analysis, the stump submodel was run with a progression of longitudinal and transverse hole spacings ranging from 3a to 12a. Longitudinal spacings are those parallel to the long axis of the pole and transverse spacings are diametrical. Two, 3/4 in. holes were placed at the center of the stump (12 in. above the groundline). With regard to the bending stress ( $S_z$ ), the stresses increased as the two holes were moved farther apart, but increased slightly again as the holes became very close (3a). This was generally true for compressive and tensile loading conditions as well as for the two bending conditions of strain applied in the Y (Fig. III-10) and X-directions (Fig. III-11).

This trend fits with the theory of using defense holes to reduce SCFs around the main hole (Ting et al. 1998). As transverse hole separation is increased, the SCF is the same as that for a single hole and as the transverse separation is decreased, the SCFs increase. However, at intermediate spacings, nearby holes can actually reduce the peak stresses around the main hole.

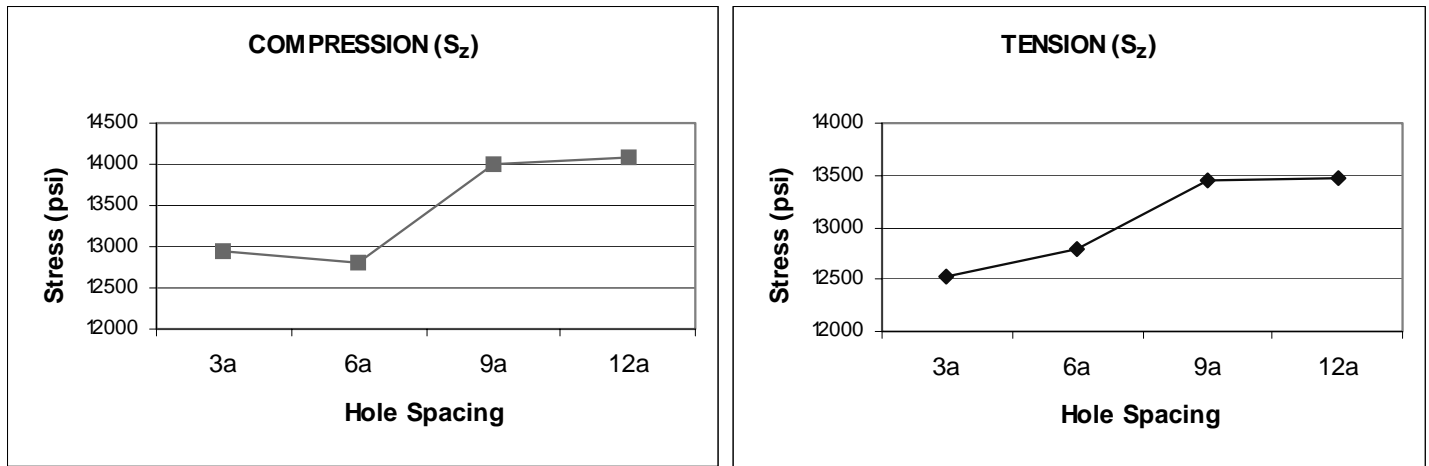

Figure III-10. Maximum bending stresses ( $S_z$ ) as a function of TRANSVERSE spacing. Loading was applied in the Y-direction.

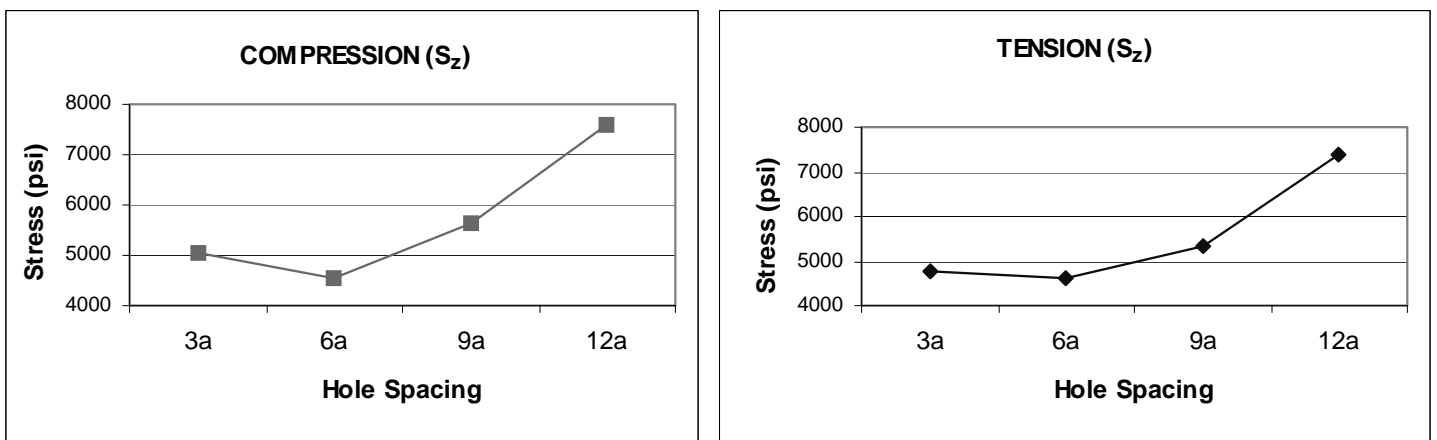

Figure III-11. Maximum bending stresses ( $S_z$ ) as a function of TRANSVERSE spacing. Loading was applied in the X-direction.

Longitudinal spacings with holes aligned were also run through the gamut of spacings and the results were similar to those predicted for a plate by Pilkey. The closer spaced holes had lower peak stresses than those spaced farther apart (Figure III-12). The larger spacing peak stresses were close to those from a single hole but slightly above the single values.

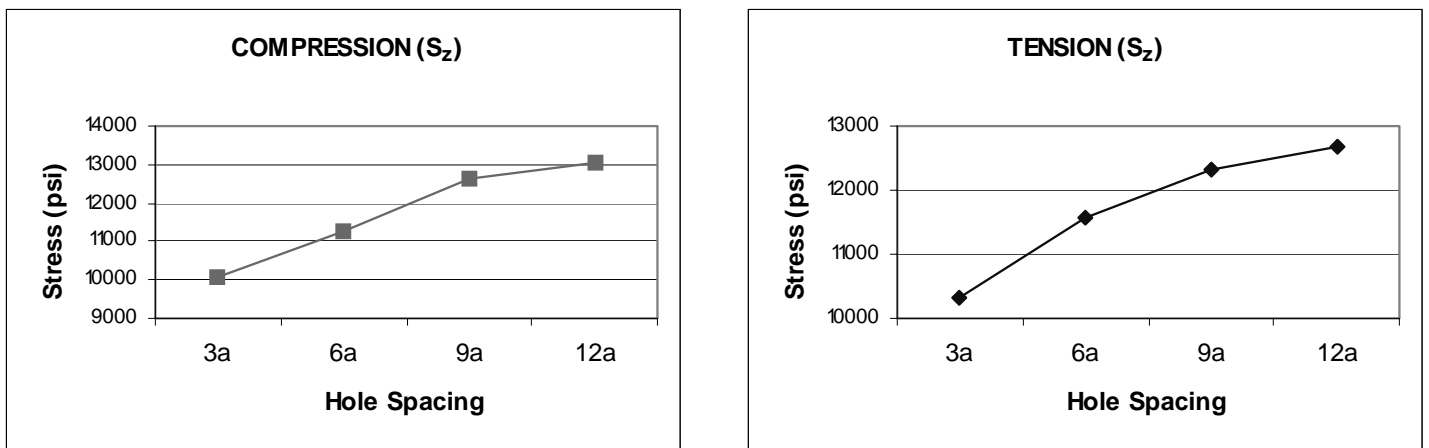

Figure III-12. Maximum bending stresses ( $S_z$ ) as a function of LONGITUDINAL spacing. Loading applied in the Y-direction.

Typical boring patterns, however, utilize holes offset at some angle to one another so this case was also examined. Two holes in the stump submodel were analyzed for lateral offset spacings of 1 and 2 in (Figure III-13). For 1-by spacing patterns, the initial hole was placed 1 in. above the groundline and 2 in. offcenter. For the 2-by spacings, the initial hole was placed at the groundline and 2 in. off center. When loaded by displacement, perpendicular to the holes, both of the spacing patterns produced the same location of peak stresses. The tensile peak bending stress was always inside the groundline hole and the compressive bending stress was always at the groundline.

No comparison was intended between the 1-by and 2-by spacing groups; the varying locations of the base hole were only to examine any effect of the groundline on the SCFs. The high stresses seen in the 2-by group are indicative of the effect of the imposed boundary restriction on the end and are not thought to be accurate in magnitude, but rather reflect the effect of increasing the longitudinal spacing while the lateral spacing is kept fixed.

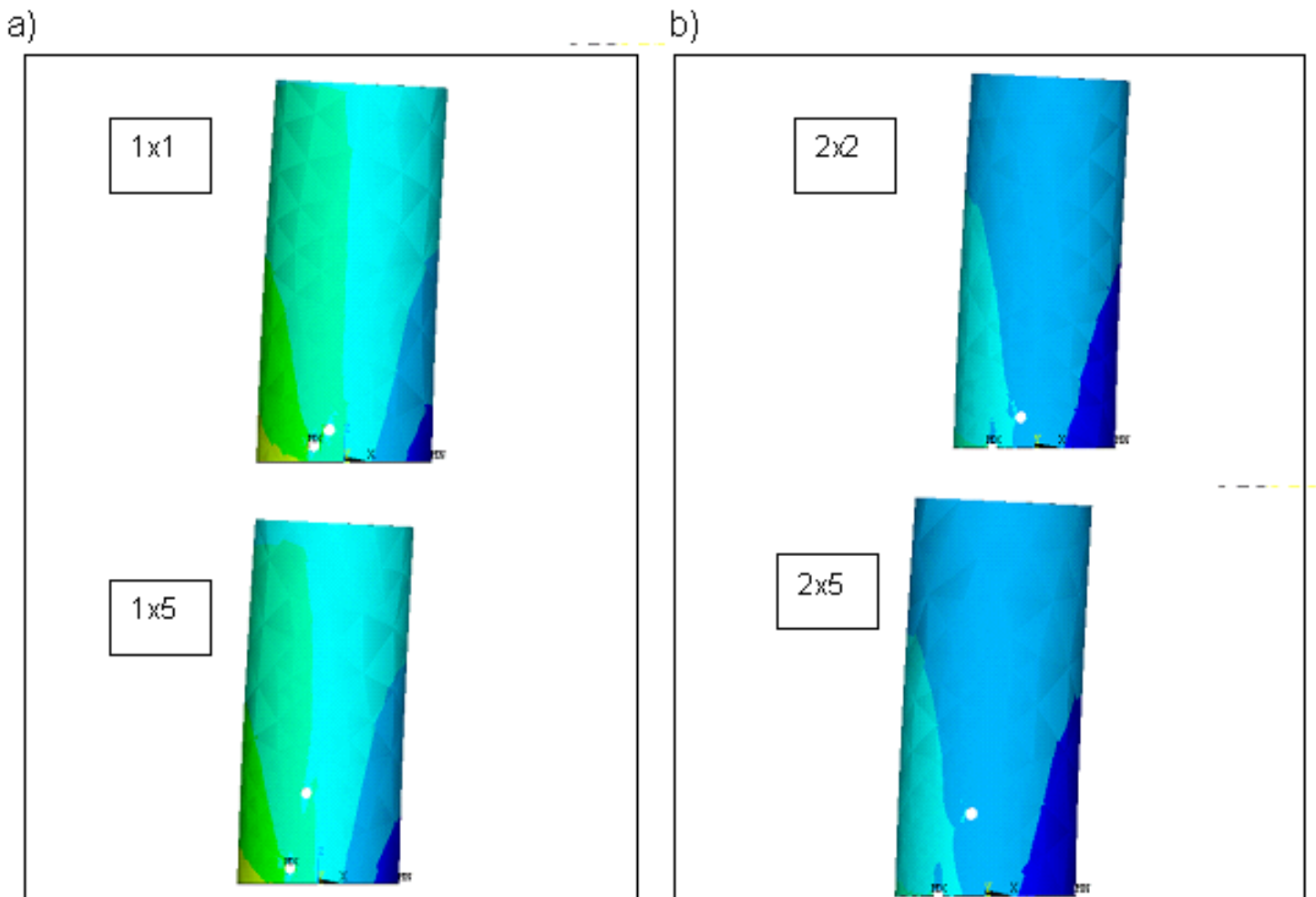

Figure III-13. Range of hole spacings in a two-dimensional plane. a) 1-by and b) 2-by spacing geometries.

Peak stress was consistently found in the same locations - inside the groundline hole (MX) and at the base of the stump (MN).

The maximum compressive stresses were higher at close spacings, then decreased in the intermediate spacings (except for one outlier) (Figure III-14). Stresses increased again as the holes were spaced further apart (1x3 was the exception to this trend).

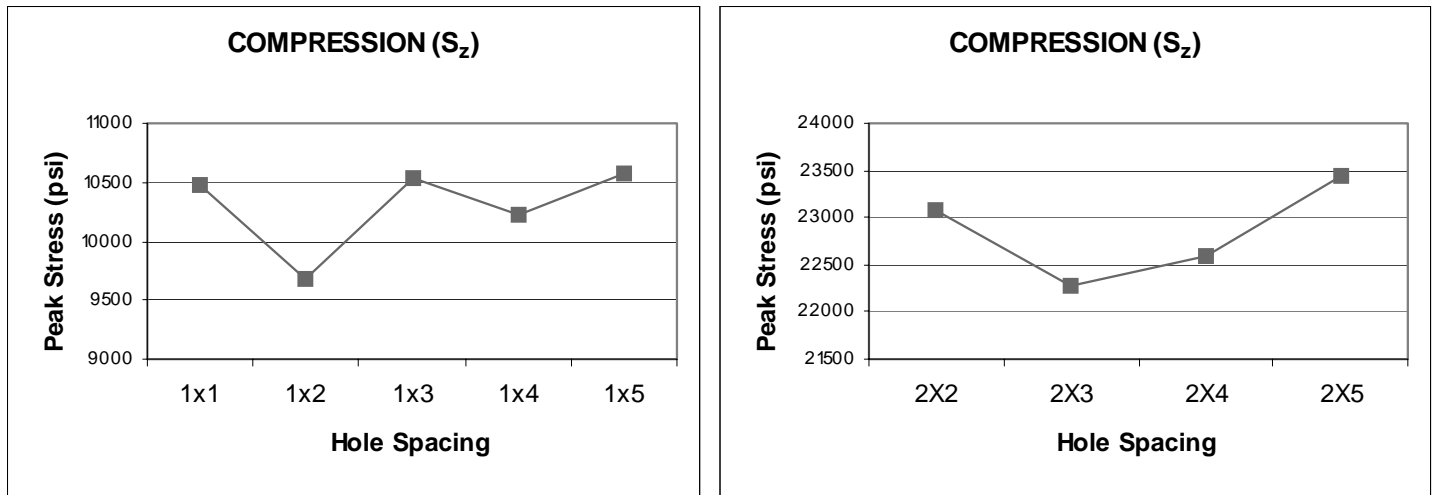

Figure III-14. 1-by and 2-by hole spacing comparison of peak bending, compressive, (S<sub>z</sub>) stress for various hole geometries.

Finally, in an attempt to examine a typical bored section, models were made of a 15 in. section of the stump bored in various pattern spacings (Figure III-15). Longitudinal spacings were utilized that produced an even number of holes along the 15 in. section and these were combined with typical lateral spacings: 1.5x3 compared to 1.5x5 (Fig. III-16) as well as 2x3 compared to 2x5 (Fig. III-17).

The transverse spacing appeared to have the largest influence on the peak groundline stresses as the larger spacing moved the hole farther from the axis of the pole and closer to the pole edge. In poles loaded perpendicular to the hole axis (the preferred loading orientation as discussed later in this document), holes in higher stressed regions produce higher SCFs. This follows the results by Falk et al. (2003). Longitudinal spacing, 3 in. versus 5 in., appeared to have little or no effect on peak SCFs.

Again, it should be noted that because the holes were modeled at the groundline where there will be an increase in stress due solely to the imposed boundary conditions, the magnitude of the stresses are over-estimated but the comparisons between the two lateral spacing configurations are valid.

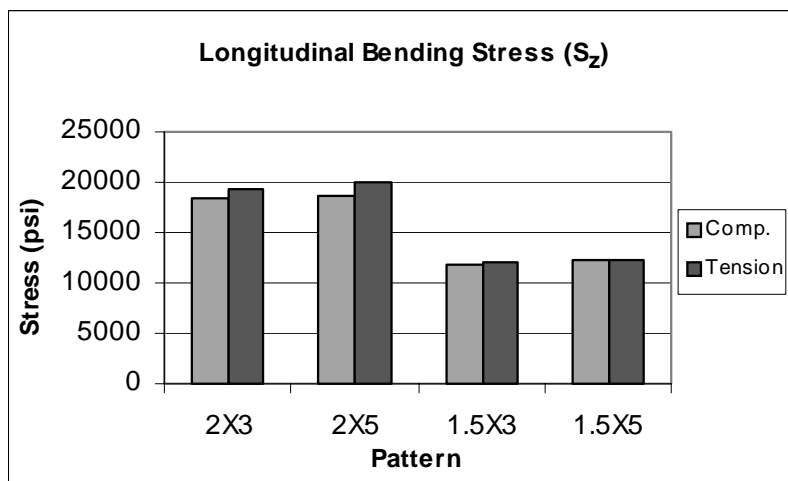

Figure III-15. Comparisons for 1-by and 2-by spacing patterns of peak bending stresses (S<sub>z</sub>) in at 15 in. stump with multiple holes.

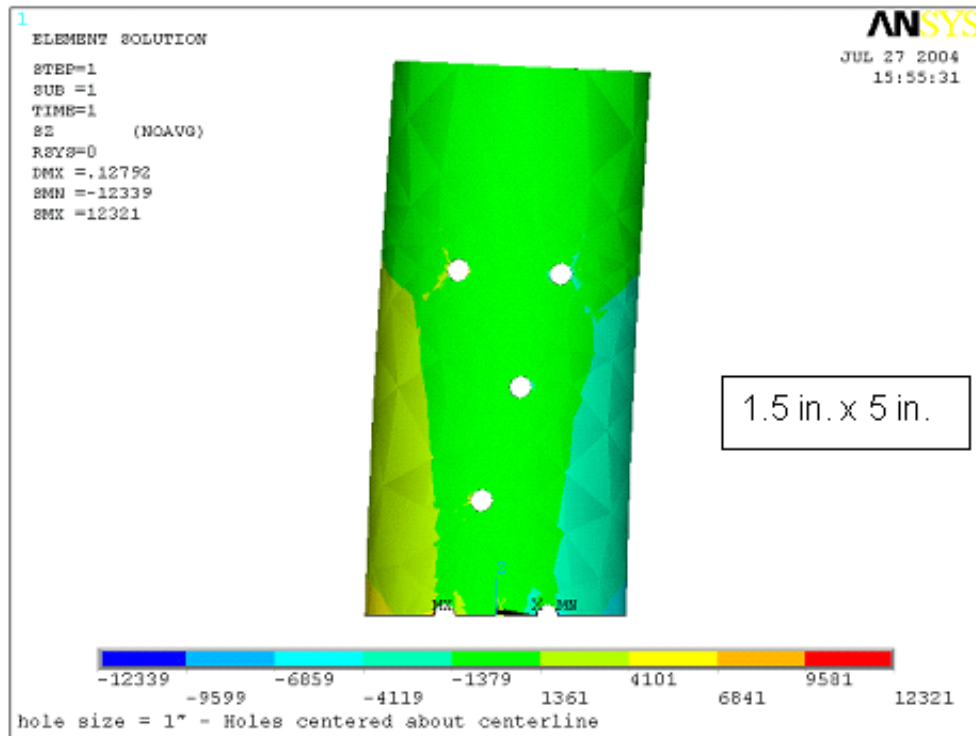
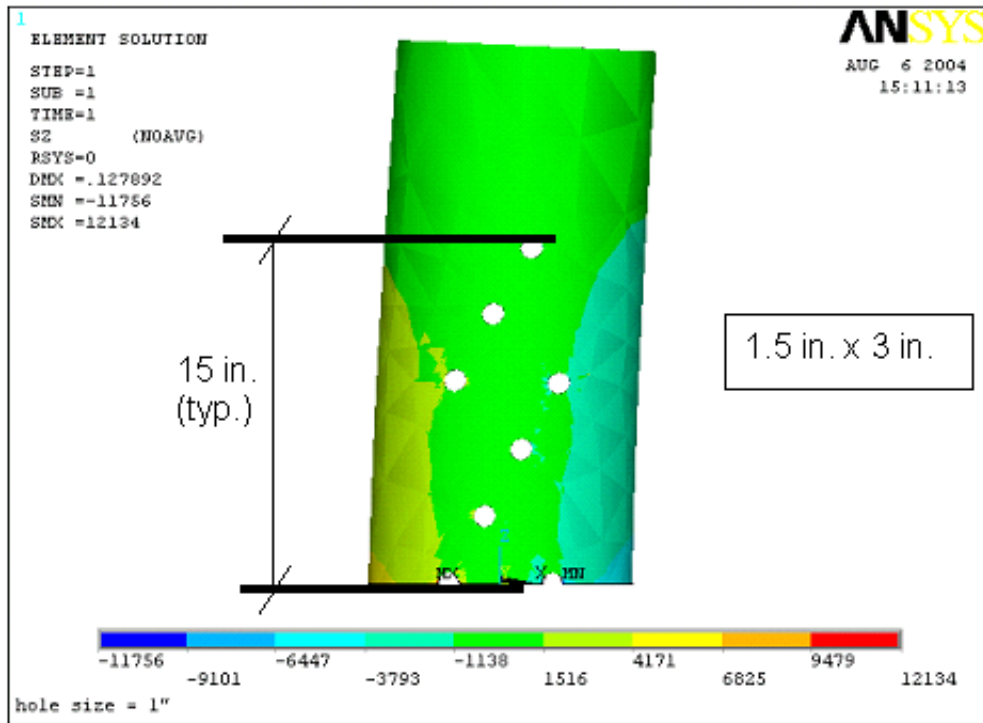

Fig. III-16. Longitudinal spacing comparisons over a 15 in. bored section with a 1.5 in. transverse spacing.

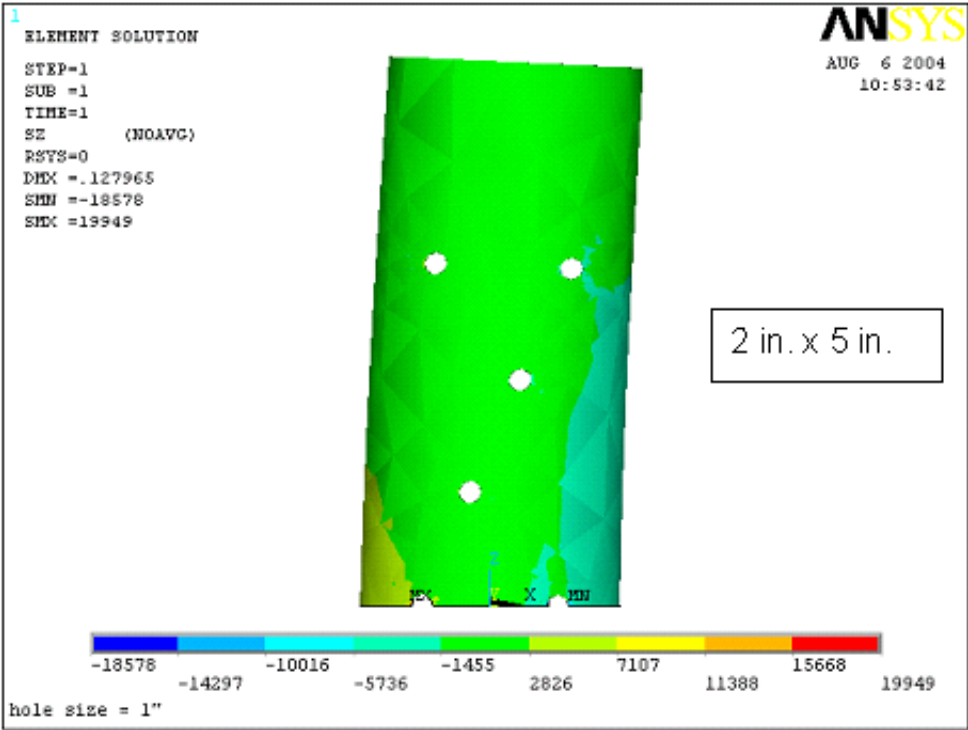
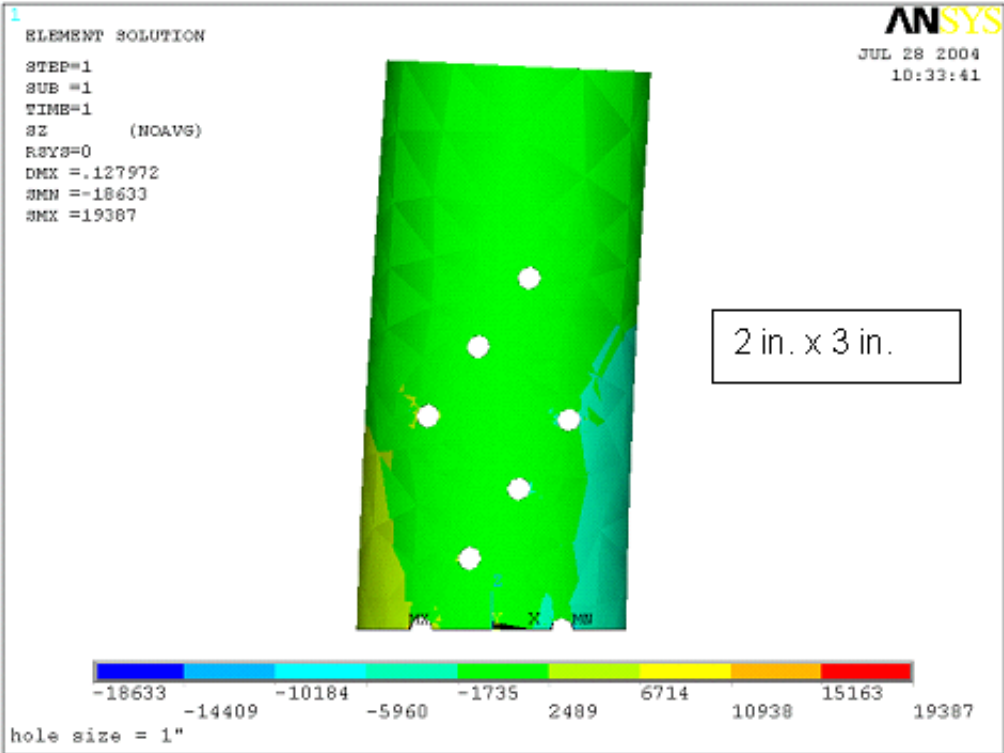

Fig. III-17. Longitudinal spacing comparisons over a 15 in. bored section with a 2.0 in. transverse spacing.



One other spacing issue that was examined, clear edge distance, had minimum effects on stresses. Various edge distances were run for three different pole sizes. The magnitudes of the peak stress as a function of edge distance are shown in Figure III-19 and show the expected trend of increasing stress with smaller edge distances.

As discussed in the previous transverse hole spacing section, the stresses increase as you move outward on the pole diameter (Fig. III-18). Therefore, the SCFs will be lower if holes are placed in the inner, lower stressed regions only. To examine if there is a critical edge dimension that should be maintained for all poles, it is necessary to analyze the results considering the increase in stresses inherent in the pole geometry and loading conditions. This was done by examining the SCFs for the various edge distances; dividing the peak stress around the hole by the peak stress in the pole region if the hole was not there. Peak stress estimates were based on finite-element stress contours with a linear increase as the hole was moved out to the edge of the pole.

In examining the SCFs for all three pole sizes, there was a large increase in SCFs between the edge distance of 1.5 in and 1.0 in (Figure III-20). However, the magnitude of the peak stresses were quite large and within the theoretical failure stresses for clear specimens at an edge distances of 2.0 in for the Class 4, 40-ft. pole and 2.5 in. for the Class 2, 70-ft. pole.

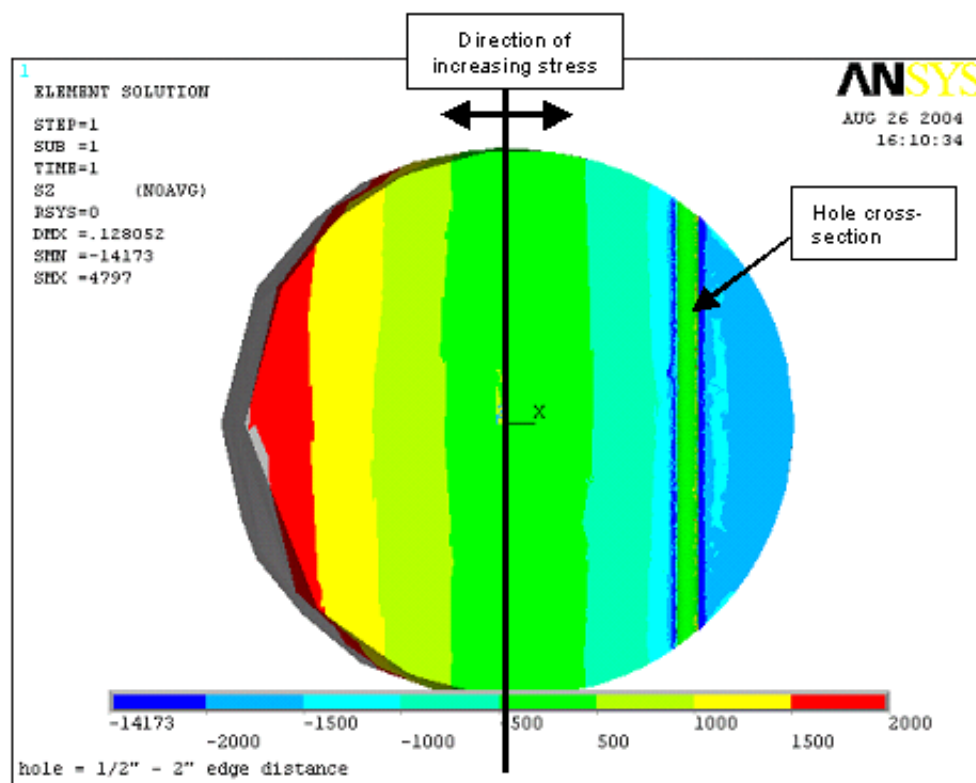

Figure III-18. Cross-section of stresses taken 12 in. up from the groundline with a 1/2 in. hole placed 2 in. from the edge.



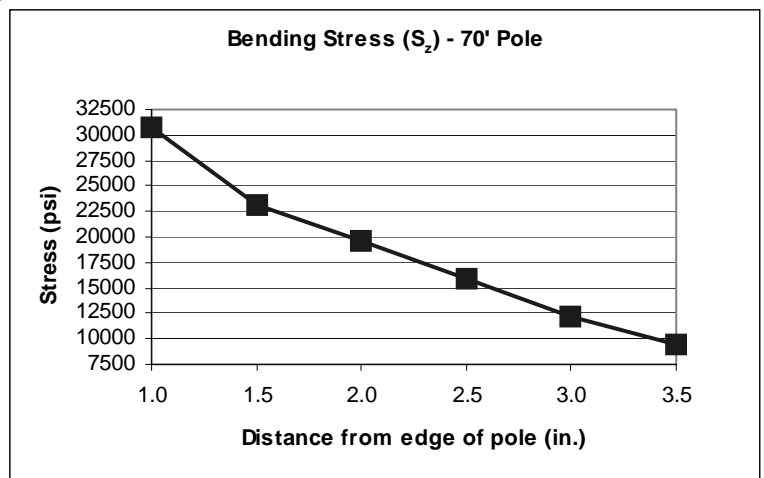
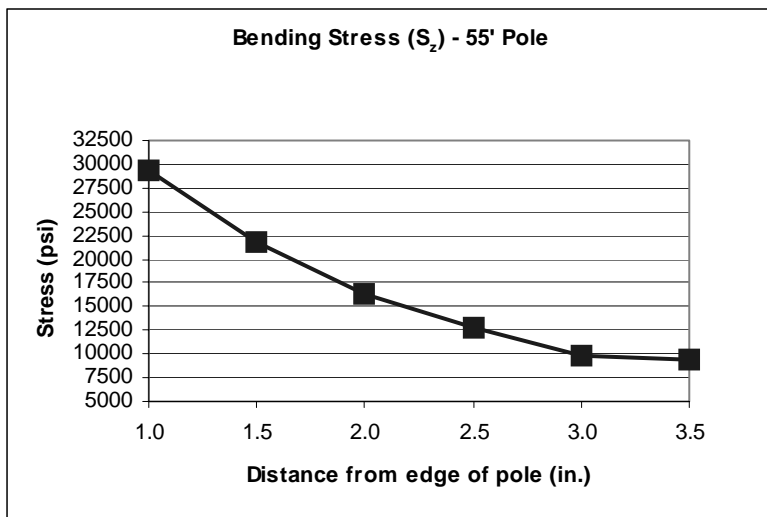
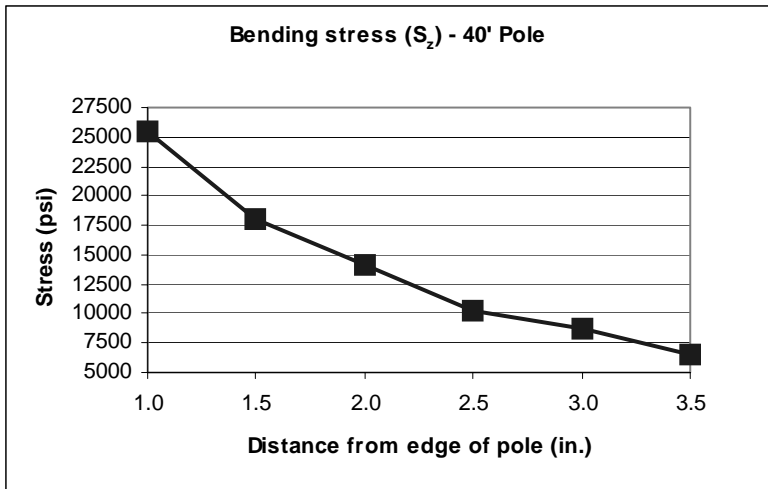

Figure III-19. Peak bending stress ( $S_2$ ) in a utility pole hole as a function of edge distance where edge distance is measured along the flat projected plane.

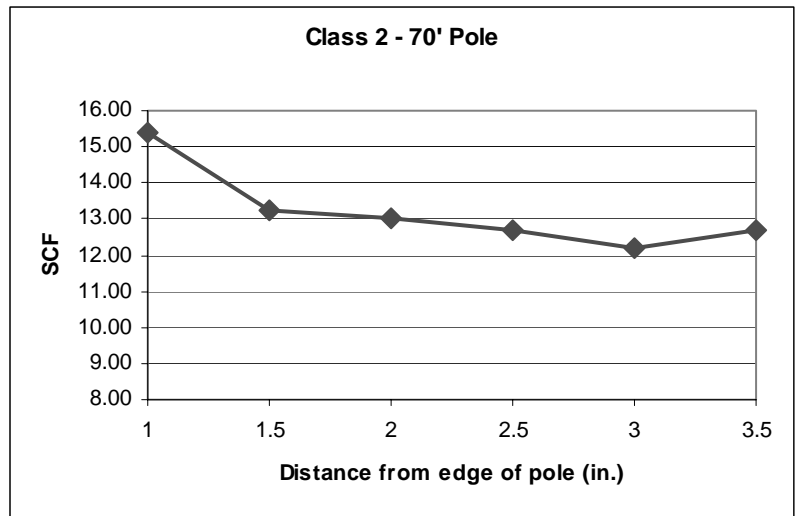
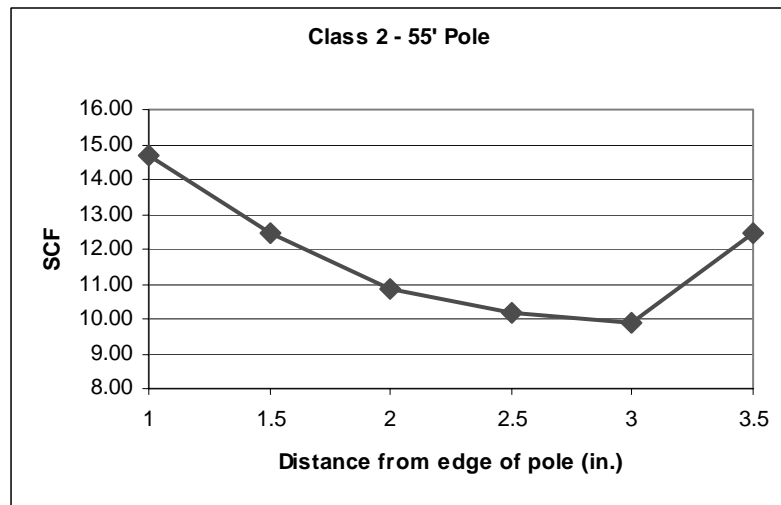
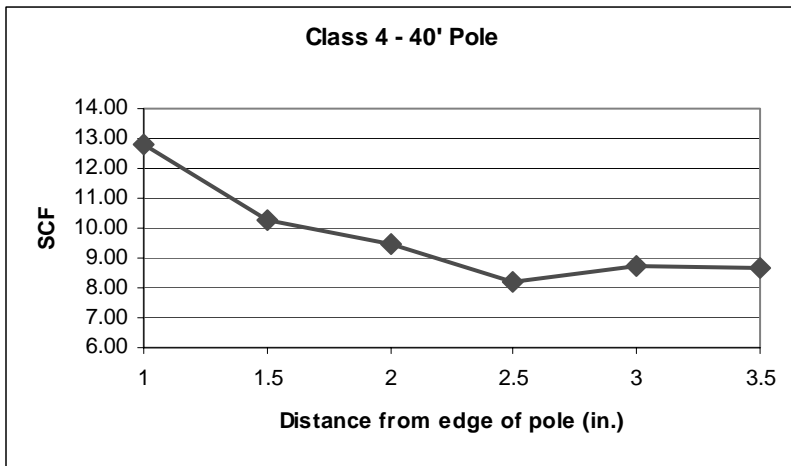

Figure III-20. SCFs as a function of edge distance in three pole classifications.

### **Load Direction**

To investigate if the Jessop theory on loading direction was correct, two hole spacing patterns (2x3 and 1.5x5) were modeled for comparison with five bore holes in a typical pattern. The model used for examining the effect of load direction was complex because of the multiple holes. Therefore, no refinement of the hole areas could be applied and a very “loose” mesh was necessary to allow the model to run. One model with a “tighter” mesh was able to run to completion for comparison purposes, but the difference between the two was minimal. Therefore, the loose mesh was accepted as adequate.

The differences in the peak stresses between the two loading patterns were clear. In tension and compression, for both spacing patterns, loading perpendicular to the holes produced significantly lower peak stresses. Peak stresses in tension for the longitudinal and transverse directions were 36 and 26% higher respectively when loaded parallel to the holes (Fig. III-21). The differences in compression were even higher because the peak stress locations differed. Loading perpendicular to the poles actually did not produce the peak stress at the hole boundary, but rather at the groundline which was considerably lower than the peak stress around the hole. (Fig. III-22)

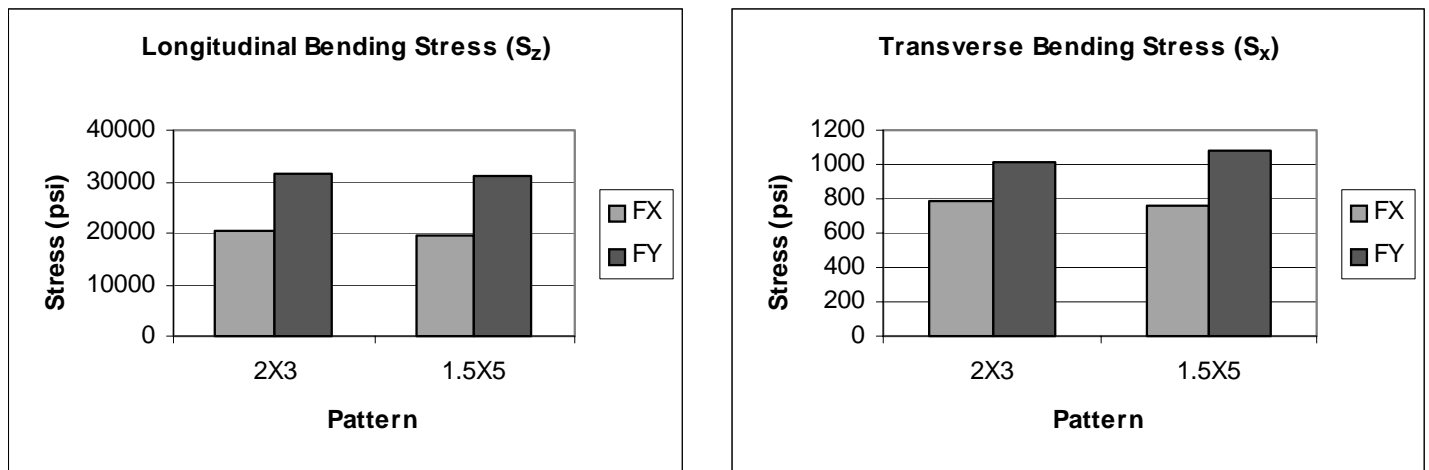

Figure III-21. Comparison of load direction (FX vs. FY) and spacing patterns (2x3 vs. 1.5x5) on stresses.

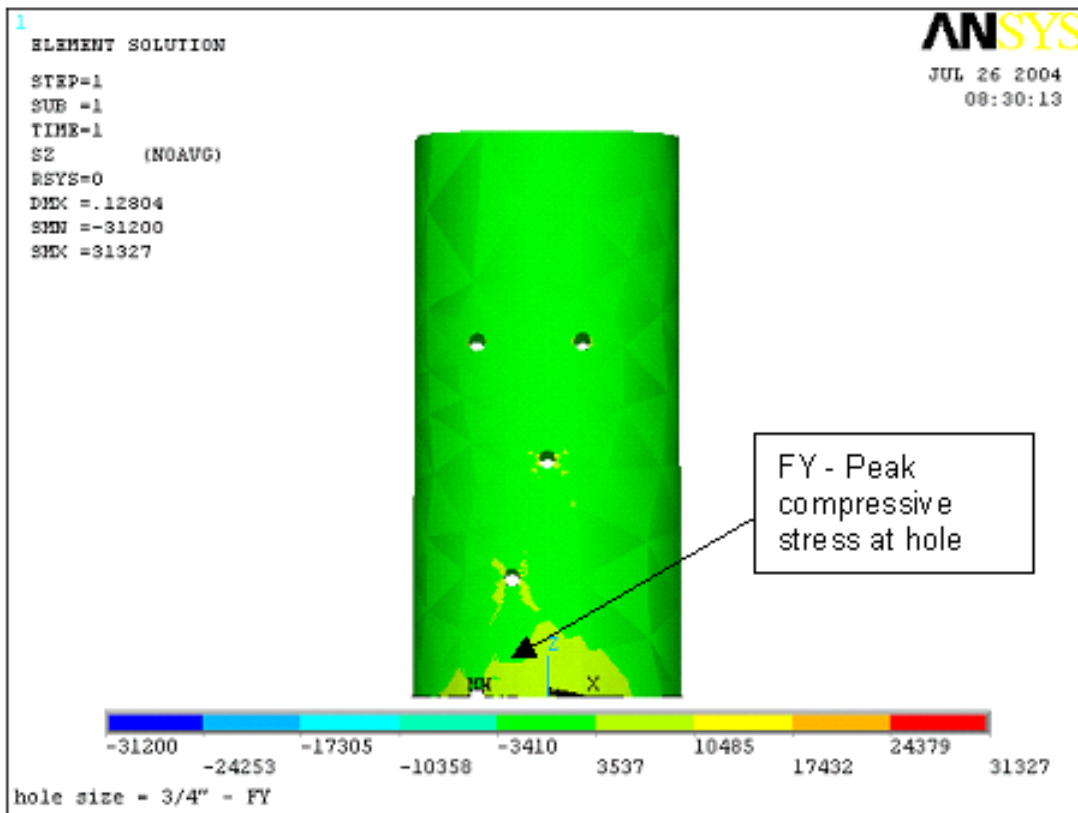
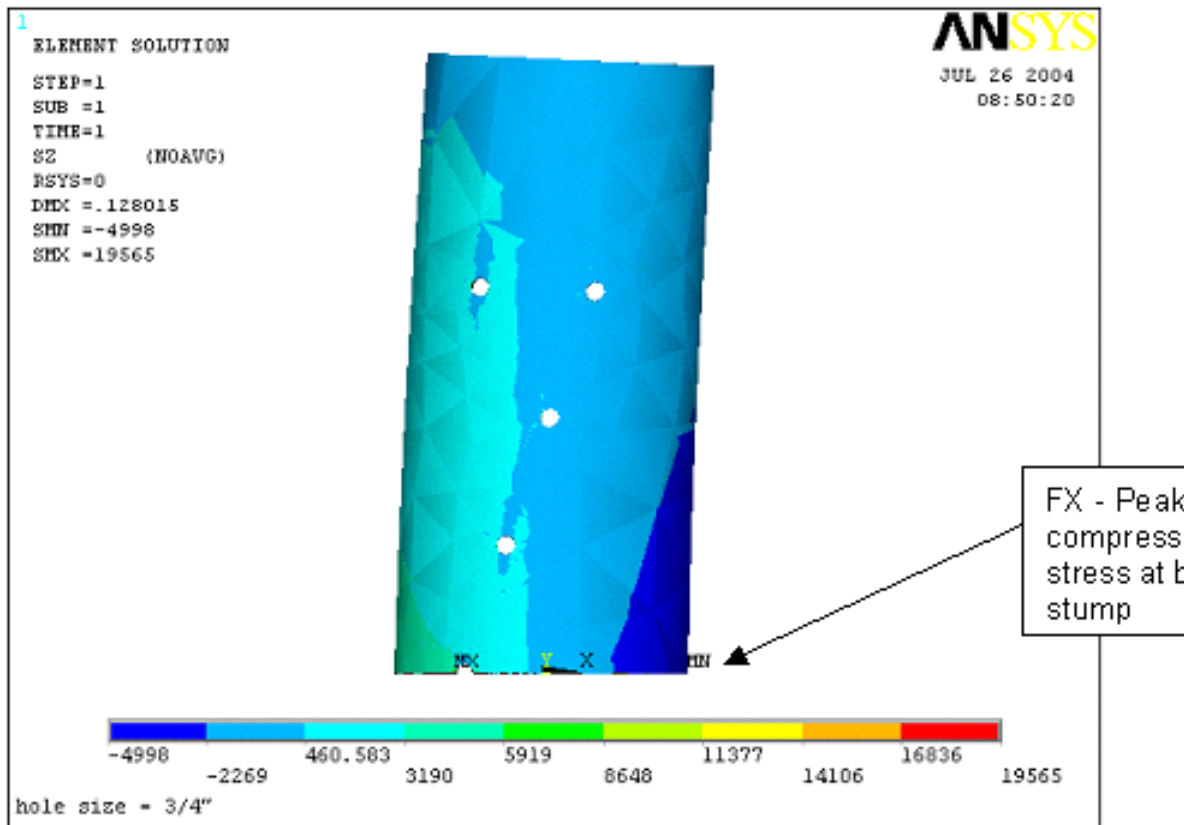

Figure III-22. Peak stress in the 1.5x5 spacing pattern for both the FX and the FY loading condition.

---

---

## SUMMARY

### **Hole Size**

Despite the limitations of the hole size modeling due to variable meshes, a general trend from all sources of information emerges showing the SCF reaches a minimum at some intermediate hole size and that very small hole sizes tend to have much higher SCFs. The research supports this trend for poles in bending; the limited number of poles tested in-situ concluded the same, and finally, the finite-element modeling supported the results. Viewed in its entirety, the information supports larger holes used for through-boring (1/2 in. – 1 in.) based on peak SCFs.

### **Hole Spacing**

In the absence of any research on the significance of unloaded holes in a solid cylinder, the finite-element modeling results, coupled with the available preservative penetration knowledge, must be used as the basis for design.

The stresses around laterally aligned holes increased for very closely spaced holes or distant hole spacings while longitudinal holes decreased SCFs as two holes were placed closer together. The presence of a second hole appears to lessen the intensity of the SCF until the two holes are spaced sufficiently far apart that they behave as one, single hole. Holes set at an angle to one another appear to follow a slightly different trend but intermediate spacings had the lowest peak stresses and spacings at the extremes exhibited the higher stresses.

The importance of hole location was demonstrated in these analyses. The critical spacing interactions were not encountered in current boring practices and the key to keeping SCFs low is transverse spacing.

The output stresses showed little change between models with six holes when compared to models with eight holes but there were markedly higher stresses between transverse spacings of 1-1/2 in. versus 2 in. The wider transverse spacing pushes holes farther out the pole diameter and closer to the pole edge, where base stresses are higher for the perpendicular loading case. The narrower spacing will allow a boring pattern to have a larger clear edge distance, which will keep peak stresses lower. This is assuming that the narrower coverage of preservative penetration remains adequate.

Finally, the modeling results showed that a clear edge distance of at least 2.0 in. should be maintained for all pole classes to avoid large SCFs.

### **Load Direction**

The assumption that poles should be loaded perpendicular to the bore hole axis appears to be justified. Past research and current finite-element analyses show that bending stresses resulting from loads applied perpendicular to the axis of the holes result in SCFs that were much lower than those incurred when the bending force was applied parallel to the holes.

## **B. Condition Assessment of Aging Douglas-fir Crossarms**

Cross arms are an important component of the overhead transmission and distribution system. Despite their importance, these assets are often over-looked in the overall inspection process because they are difficult and expensive to inspect.

Wooden cross-arms continue to be the mainstay of distribution and lower voltage transmission lines, but there is little data on the overall service lives of these materials. The majority of crossarms are Douglas-fir pressure treated with pentachlorophenol in P9 Type A oil. The arms are generally pre-drilled prior to treatment, sharply reducing the risk of internal decay development through exposed untreated wood and the location of the arms away from direct soil contact sharply reduces the risk of decay. On the down side, crossarms are often treated while the moisture contents are elevated and the majority of the exposed surfaces are heartwood, sharply reducing the depth of treatment, even when the wood is incised prior to treatment. The effects of the combination of reduced decay risk and shallower treatment on crossarm performance remain poorly understood. In most instances, utilities replace crossarms as needed- usually when failures occur or during routine upgrades or other service changes- because the cost of line personnel time on the pole far exceeds the relatively small cost of the wood. As a result, there is little information on the types of failures experienced with crossarms or the rate at which these failures occur.

Crossarm performance will take on increased importance as utilities continue to use groundline inspection and treatment programs to arrest internal and external decay at groundline. We have already begun to see utilities entering their third and fourth cycles with poles in the 40 to 60 year range as they limit the extent of decay at groundline. Decay above ground, which typically occurs slowly and requires many years to become a performance factor, will become increasingly important. Crossarms that might typically have been replaced as part of a pole change out will now be in service for many decades, often with minimal inspection as long as they perform acceptably. The performance of these components will then become an important part of the overall structural performance.

As a part of our effort to assess the risk of decay above ground, we have examined the incidence of decay in the above ground portions of older Douglas-fir poles in the Pacific Northwest, both through a survey of above ground decay in transmission poles and inspection of the conductored portions of older Douglas-fir distribution poles. Both of these surveys highlighted the incidence of internal decay above ground in older poles. In addition, we have examined the condition of older Douglas-fir laminated davit arms, but we have had little opportunity to examine the condition of older solid-sawn crossarms. This past year, we had the opportunity to examine a series of older wishbone crossarms in the Portland General Electric (PGE) system. The crossarms were pentachlorophenol treated Douglas-fir arms that were installed in a wishbone-type configuration (Figure III-23). The arms had been in service for 45 to 60 years. It is unclear whether the arms were pre-drilled prior to treatment although post testing sampling of some arms suggested that they were.

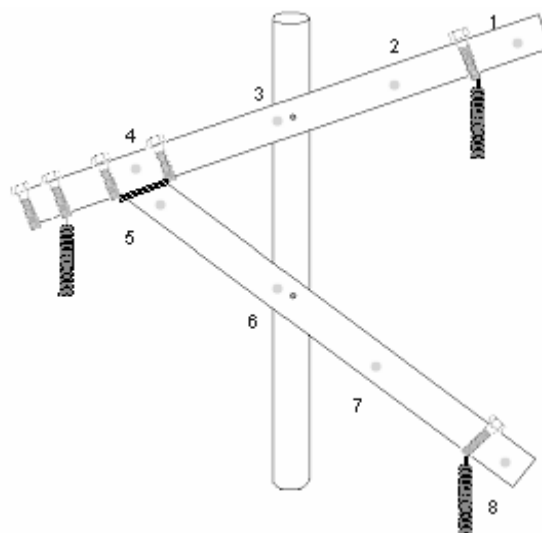

Figure III-23. Example of a wishbone type crossarm configuration.

---

The condition of the arms was assessed in two tests. In one phase, 30 arms were removed from service and returned to OSU along with 2 newly treated arms, where they were conditioned to a stable moisture content, then tested to failure in bending. The resulting data were used to determine modulus of elasticity and modulus of rupture. These values can then be used to assess the residual material properties of the arms in relation to the line loads. In addition, the arms were examined prior to bending tests using several non-destructive acoustic tools that used time of flight along the length of the pole to predict bending strength.

Prior to mechanical testing, increment cores were removed from each arm. Samples were removed from within 50 mm of bolt holes at four locations along each crossarm (Figure III-23). The cores were examined for evidence of visible decay, then cultured for the presence of decay fungi. The combination of visual examination and culturing should provide information on both the presence of existing damage as well as the risk of continued fungal attack.

The arms were then cut into 0.6 m lengths using a chainsaw. A 50 mm thick section was cut from one end of each resulting section to determine the extent of internal decay, and the sections from a given cross arm were photographed for later assessment. The outer 15 mm from the upper surface and one side of each 50 mm section was then removed and ground to pass a 20 mesh screen. A subsample of the resulting material was then analyzed for pentachlorophenol by x-ray fluorescence spectroscopy. The purpose of these analyses was to determine if the arms contained sufficient preservative to provide continued protection against fungal attack. In addition to the above assessment, we also have a Resistograph which we will use to assess the condition of the arms.

In addition to the limited destructive testing, we performed a more general sampling of arms in service in cooperation with PGE line personnel. A total of 120 arms (on 60 poles) were inspected by PGE line personnel. Line personnel sounded each arm and tested in their normal manner and reported any defects they found. In addition, they removed increment cores from zones immediately adjacent to each bolt hole on the upper arm and increment cores from the joint end of the lower cross along with cores from the two bolt holes on this arm (Figure III-23). The holes from each core were plugged with tight fitting wood dowels. The cores were placed in plastic straws and stapled shut for transport to OSU. Once there, each core was examined for the presence of decay, and then the untreated portion was cultured for the presence of decay fungi and the depth of preservative treatment was noted. Finally, the outer 15 mm of core was ground to pass a 20 mesh screen. The ground wood from the cores from a given cross arm were combined and analyzed for pentachlorophenol by x-ray fluorescence spectroscopy. The objective of these additional inspections was to develop a linkage between our laboratory findings and those that the line personnel might detect using conventional inspection techniques.

The arms inspected in service tended to be heavily weathered and had numerous checks on the upper surfaces. In many instances, mosses and other vegetation were present on the upper surfaces of the arms and the outer appearance would suggest the presence of internal decay. Increment cores removed from the arms tended to be broken and fractured; often a sign of some decay. However, the cores did not contain evidence of advanced decay and culturing of the cores resulted in little or no evidence that viable decay fungi were present in most of the arms (Table III-2). Decay fungi were isolated from only 1 of the 120 arms examined. Isolations of non-decay fungi in the arms were also relatively low, with only 25 of the 120 arms containing any viable fungi. These seemingly contradictory results are perplexing; however, we suspect that most of the external damage noted on the arms was the result of ultraviolet light degradation. The development of deep checks most probably resulted from the repeated wetting and drying over the 45 to 60 years of service. These cycles can be particularly severe in Western

Table III-2. Residual pentachlorophenol and degree of fungal colonization in 120 Douglas-fir crossarms inspected after 45 to 60 years of service in the Willamette Valley of Western Oregon.

Pole #	Pentachlorophenol (Kg/m <sup>3</sup> )		Decay fungi (% of cores)		Other fungi (% of cores)	
	upper	lower	upper	lower	upper	lower
1	2.22	2.16	0	0	50	0
2	2.37	1.61	0	0	25	0
3	2.78	1.97	0	0	0	0
4	1.39	2.08	0	0	0	0
5	0.95	1.76	0	0	0	0
6	1.25	2.82	0	0	25	0
7	2.20	1.99	0	0	50	50
8	1.55	1.71	0	25	25	25
9	1.17	2.13	0	0	0	0
10	1.58	1.47	0	0	0	0
11	1.25	1.66	0	0	0	25
12	0.30	0.22	0	0	50	50
13	0.16	0.04	0	0	25	25
14	0.04	0.18	0	0	0	25
15	0.10	0.14	0	0	0	50
16	0.19	0.22	0	0	0	25
17	0.24	0.24	0	0	25	25
18	0.11	0.06	0	0	100	25
19	0.06	0.18	0	0	0	0
20	0.26	0.15	0	0	0	25
21	0.20	0.22	0	0	0	0
22	0.22	0.17	0	0	0	0
23	0.10	0.06	0	0	0	25
24	0.02	0.14	0	0	0	0
25	0.17	0.24	0	0	0	0
26	2.27	1.59	0	0	0	0
27	2.99	1.61	0	0	0	0
28	1.51	4.52	0	0	0	0
29	2.15	4.36	0	0	0	0
30	3.11	1.68	0	0	0	0
31	1.93	4.73	0	0	25	0
32	1.86	1.07	0	0	25	0
33	1.38	6.25	0	0	0	0
34	1.88	2.07	0	0	0	25
35	1.17	0.42	0	0	0	0
36	0.34	0.68	0	0	0	0
37	2.02	2.16	0	0	0	25
38	1.66	0.21	0	0	0	0
39	0.46	0.48	0	0	50	0
40	0.76	0.35	0	0	25	0
41	0.36	0.89	0	0	0	0
42	0.43	1.91	0	0	0	0
43	0.81	0.53	0	0	0	0
44	0.64	1.40	0	0	0	0
45	0.04	0.14	0	0	0	0
46	0.16	0.17	0	0	0	25
47	0.24	0.17	0	0	0	25
48	0.13	0.05	0	0	0	0
49	0.06	0.10	0	0	0	0
50	-0.02	0.17	0	0	25	0
51	1.41	2.48	0	0	0	0
52	0.24	0.20	0	0	0	25
53	0.12	0.08	0	0	0	0
54	0.03	0.10	0	0	0	0
55	-0.01	0.13	0	0	0	0
56	0.20	0.21	0	0	0	0
57	0.19	0.21	0	0	0	0
58	0.13	0.00	0	0	0	0
59	0.18	0.09	0	0	0	0
60	0.16	0.20	0	0	0	0



---

Oregon because of the very wet winters followed by the near absence of rainfall during the summer. As a result, arms can be very wet in the winter but extremely dry during the summer. The drying stresses induced by these cyclic moisture changes could gradually exacerbate checking.

The relatively low levels of fungal colonization in the arms may reflect the continued protection of the initial treatment coupled with the lower decay risk for wood exposed above ground. This is particularly true for Douglas-fir heartwood, which is moderately durable and has performed extremely well in above ground exposures, even without supplemental preservative protection. The addition of even a small amount of chemical protection can produce dramatic increases in durability of this species, as shown in Objective II. Penta assays revealed that retentions ranged from as low as  $0.03 \text{ kg/m}^3$  to  $6.25 \text{ kg/m}^3$  (Table III-2). The current specification for treatment of Douglas-fir cross arms with pentachlorophenol (C25-01) specifies retentions of 4.8 or  $9.6 \text{ kg/m}^3$ , depending on the degree of decay hazard to which the arm will be exposed. The vast majority of arms inspected in our tests contained far less than the recommended initial retentions; however, the initial retentions are designed to provide a safety factor so that a vast majority of wood pieces will be treated to retentions above the threshold for fungal growth. The threshold for fungal attack of penta in soil contact is considered to be approximately  $2.4 \text{ kg/m}^3$ . This level is likely to be far in excess of that needed to protect wood in non-soil contact, but we can use it as a guideline. Of the 120 assays performed, only 11 exceeded the threshold for soil contact, while 26 were within  $0.1 \text{ kg/m}^3$  of the threshold. Clearly, the arms do not contain high levels of residual penta; however, it is difficult to use the residual chemical levels as a measure of future risk in the absence of knowledge of the original preservative retention. There are, however, a number of arms where the level of surface protection is extremely low.

The current ANSI Standard 05.3 lists assumed designated fiber stresses of 7800 psi for arms less than 12 feet or 7400 psi for heavy duty crossarms. It is important to remember that not all arms in a given population will meet this value, but the average of all arms should fall near one of these values (depending on the application). Full scale bending tests revealed that MOR's for most arms fell below the 7400 psi value (Table III-3). Only 4 of the 28 arms that had been removed from service met this value, while 13 of 28 arms had MOR's greater than 6000 psi and 18 of 28 had MOR's of at least 5000 psi. If we use the current fiber stress designation (7400 psi) as our basis for initial strength, then use the NESC requirement that the system be able to hold at least 67 % of its original design value, then the arms should be able to support 4958 psi. Clearly, a number of the arms have MORs that are well below that value; however, it is important to remember that the strength of wood varies widely and the presence of some weaker arms is consistent with this variation. In addition, the effects of initial treatment (the ANSI values are for untreated wood) would further reduce the initial material properties. Weathering of the arms and the presence of deep checks would also impact bending strength to some extent. Given these possible effects, these arms appear to be in excellent overall condition, despite their appearance.

The potential for using non-destructive tests to assess arm condition was examined using two tests. The Metriguard is a time of flight acoustic test. Briefly, sound will move more slowly through weaker wood and this time can be correlated to various wood properties, particularly density. In our tests, the device was used to assess time of flight longitudinally in the arms either prior to bending tests or when the arms had been loaded to 3000 or 6000 psi. The Metriguard provided a time of flight value in microseconds. The MK-4 Hammer was used on the arms under similar loading conditions and provided a number ranging from 1 to 10. Each arm was tested in at least three locations along the length of the arm at a given loading condition and these values were averaged for that loading condition.

Table III-3. Condition of Douglas-fir cross arms following 45 to 60 years of service as measured by bending tests to calculate modulus of rupture (MOR), modulus of elasticity (MOE) as well as two non-destructive acoustic tests (Metriguard and the MK-4 Hammer).

Crossarm # Location <sup>1</sup>	Avg penta (Kg/m <sup>3</sup> )	MOE	MOR	Max load	Metriguard			hammer			
					prior	3000	6000	prior	3000	6000	
586	L	0.798	1.914	7512	13288	768	781	783	1.0	1.0	1.1
587	U	1.207	2.319	5934	10497	776	773	762	1.6	1.7	1.7
588	U	3.228	1.884	5336	9439	832	837	828	1.6	1.1	1.3
589	U	2.024	2.404	6087	10768	846	821	827	1.0	1.4	1.4
590	L	1.683	1.751	4755	8411	773	775	765	1.4	1.0	1.4
591	U	4.841	1.824	3982	7045	857	866	865	2.7	2.0	2.4
592	L	-0.197	1.872	4560	8067	758	767	751	1.6	1.3	1.4
593	L	2.152	1.956	6752	11944	790	774	789	1.4	1.3	1.1
594	U	2.408	2.290	5294	9365	775	778	778	1.4	1.4	1.4
595	L	1.939	1.813	5461	9661	735	719	716	1.9	2.1	2.3
596	L	4.663	2.534	7398	13087	715	722		1.3	1.3	
597	L	1.606	1.567	3296	5831	754	761		1.9	1.4	
598	U	0.864	2.341	4320	7641	761	768	768	1.9	1.6	1.4
599	L	2.557	0.276	1490	2636	775			2.0		
600	U	0.980			9430	769	788	779	2.1	1.6	1.9
1582	U	0.326	1.185	2948	5215	838	845		1.3	1.9	
1583	U	2.483	1.777	3221	5698	827	829		2.0	1.6	
1584	U	1.147	1.724	6699	11851	818	820	822	1.7	1.7	1.7
1585	L	0.718	1.953	7148	12645	798	808	784	1.6	1.6	1.3
1586	L	2.250	1.931	6262	11077	752	741	736	1.4	1.9	1.7
1587	U	0.686	1.677	3963	7011	829	829	822	1.4	1.4	1.4
1588	U	4.820	1.988	8579	15175	810	802	800	1.7	1.9	1.7
1589	L	1.590	1.825	7244	12814	787	770	755	2.0	1.4	2.1
1590	L	1.404	1.606	6006	10625	792	771	770	1.6	2.3	2.0
1591	U	0.881	1.629	5411	9571	805	820	825	2.4	2.1	2.9
1592	L	2.690	1.817	4693	8302	818	808	805	1.3	1.3	1.3
1593	U	0.188	1.682	4939	8737	813	813	800	1.9	1.9	1.6
1594	U	0.146	1.861	6602	11678	822	817	797	1.1	1.4	1.3
1595	L	2.495	1.947	6327	11192	815	819	832	2.1	2.1	2.4
1596	L	1.728	2.173	8390	14841	702	710	730	2.3	2.1	2.0
1597	NS	5.301	1.066	6001	6592	455	455	452	1.3	1.0	1.3
1598	NS	4.927	0.902	4887	5369	446	446	442	1.1	1.0	1.0

1. L = lower crossarm, U = upper crossarm and NS = never in service.

Values for the Metriguard system varied only slightly with loading condition (Table III-3). As a result, we will discuss the results in terms of the initial tests with no applied load. There appeared to be no consistent relationship between time-of-flight and MOR for the arms (Figure III-24). In many cases, the highest values were associated with weaker arms, while the opposite was true in others. The MK4 Hammer produced similar inconsistent results. In a number of cases, the values were higher for weaker samples, but in other cases stronger arms had high readings (Figure III-25). The inconsistencies inherent in both devices highlight the difficulty of using non-destructive tools for assessing residual strength of materials without prior knowledge of wood condition. A portion of this inconsistency probably derives from the excessive weathering associated with many arms. Surface features such as these are more difficult to detect using the time of flight instruments in the longitudinal direction, but this damage can have substantial impacts on bending properties. The results indicate that there are no simple tools for line personnel to use in assessing the condition of aging crossarms.

NDE assessment of the arms using the Hitman sonic testing device produced results that were similar to those found with the other two NDE devices (Figure III-26, Table III-4). The device detected the one arm with serious internal decay, but it also indicated low strength for two other arms that had moderate residual strength and missed several other arms with similarly lower strength values. An ideal inspection device would have a high probability of detecting seriously damaged materials and a relatively lower probability of suggesting that sound materials were decayed. Devices that predict too many samples are

a.

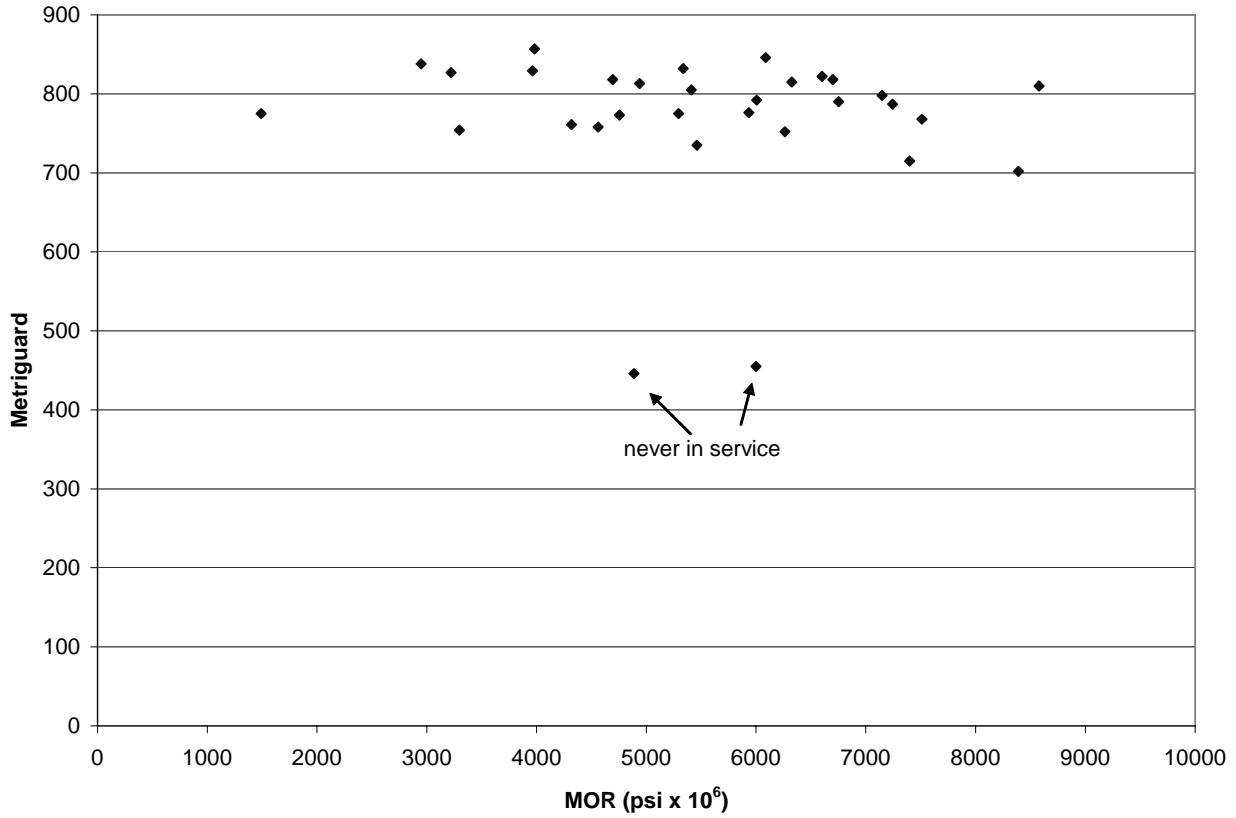

b.

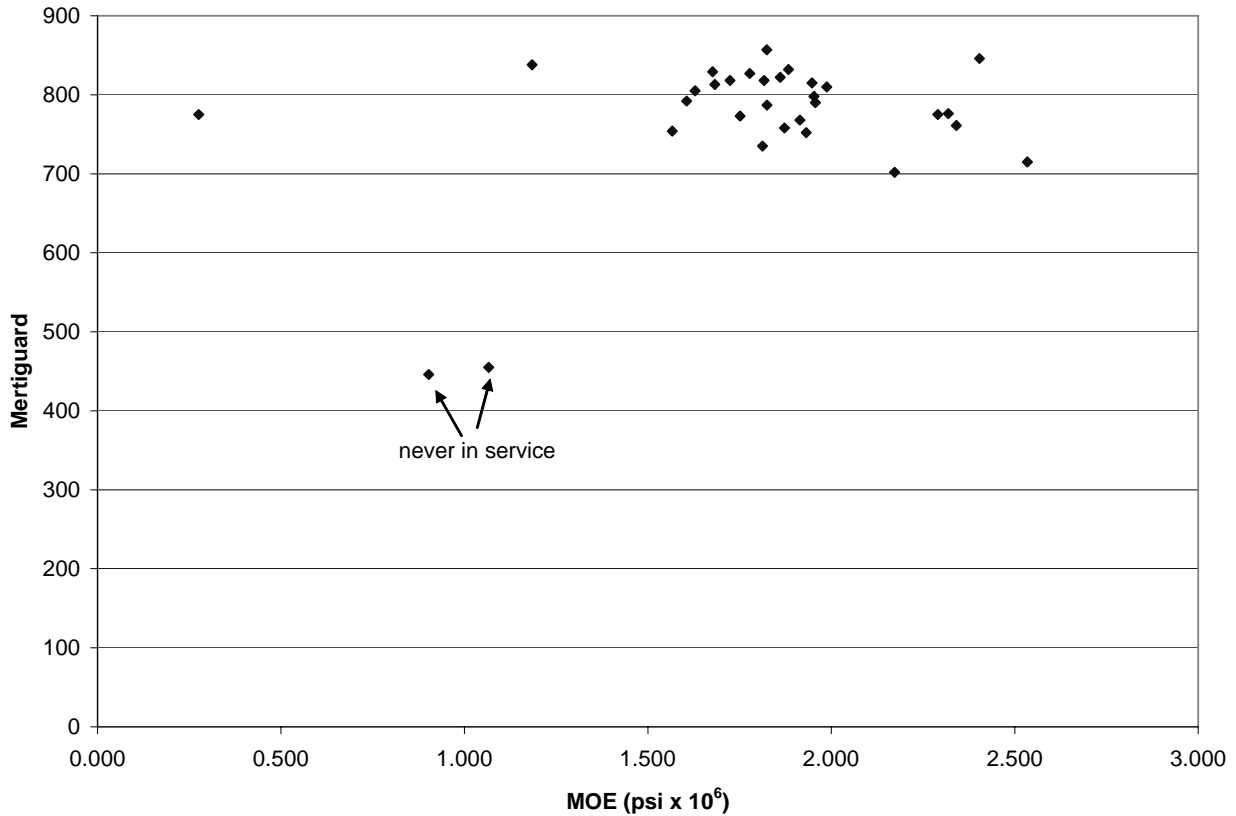

Figure III-24. Relationship between non-destructive assessments using a Metriguard and a) MOR or b) MOE of Douglas-fir cross arms removed after 45 to 60 years of exposure.

Table III-4. Condition of Douglas-fir cross arms following 45 to 60 years of service as measured by the non-destructive Hitman acoustic test at 0.6 m increments along the length of the arm.

Crossarm #	Hitman						average
	position on crossarm						
	A	B	C	D	E	F	
586	25558	12073	11745	11745	25623		17349
587	18701	18701					18701
588	17717	17717	17782				17739
589	17848	17913	17848				17870
590	11549	18340					14945
591	24442	24442					24442
592	8825	8891	8891				8869
593	25427	25427	25361	11155	8235		19121
594	18570	18406	18340				18439
595	18734	18734	18734				18734
596	18274	18274	18274	18340	18340		18300
597	17913	17871	9285	9361			13608
598	19012	18996	19127				19045
599	7120	7119	7119				7119
600	18635	18570	18701	18570	18471		18589
1569	18799	18799	18799	18734	18799	18799	18788
1582	16503						16503
1583	19423	19357	19423				19401
1584	18405	18209	18143				18252
1585	18209	18471	18208				18296
1586	18406	18471	18471				18449
1587	8891	8871	8957	17910			11157
1588	18340	18340	18274				18318
1589	26148	26148	26083				26126
1590	18307	18307	12041	18307	18307		17054
1591	18635	20046	19521	19816			19505
1592	8891	8878	8889				8886
1593	18274	18274	18340				18296
1594	20471	18406	18471	18471			18955
1595	18012	24705	24770	24705	18605		22159
1597	16962	15059	17028	15748	17093		16378
1598	16399	16273	16339				16337

decayed will result in either excessive additional inspection time or, in the absence of this additional inspection, excessive rejection rates. Either of these outcomes sharply reduces the value of the NDE device. The three NDE devices examined in this study all failed to reliably separate the damaged wood without also identifying an excessive number of sound arms as decayed under the test conditions. As a result, none would be suitable for assessing arm condition in situ.

The Resistograph is a controlled torque drill that was originally designed for detecting internal decay pockets in standing trees. While this device is not truly non-destructive, the hole it creates is fairly

small. The advantage of the Resistograph is that it produces hardcopy output showing readings with distance inward from the surface. This output can then be used to detect decay pockets or other internal defects. We used the Resistograph at 13 locations along the length of three arms. One of the arms had obvious decay pockets, another had a small decay pocket in one portion of the arm and the third had no visible decay. The locations corresponded to sites immediately adjacent to where the cross arms were cut and photographed as well as midway between cut segments.

The results showed that the Resistograph was capable of detecting the advanced decay in the most seriously degraded arm as well as the arm with the small decay pocket (Figure III-27). The instrument seemed to be relatively insensitive to surface checking, which makes it more useful for this purpose since it can ignore the surface damage. It may, however, be useful to develop some rating for degree of surface damage that line personnel could use to assess external condition in addition to the internal inspection. The device did appear to have some difficulty in producing distinctive lines in oil treated portions in the center of the arms; however, the patterns produced were very different from those produced in the decayed zones. In addition, the use of this device in the energized zone of the pole may be problematic, however, the preliminary tests suggest the Resistograph may be a useful tool for assessing internal condition.

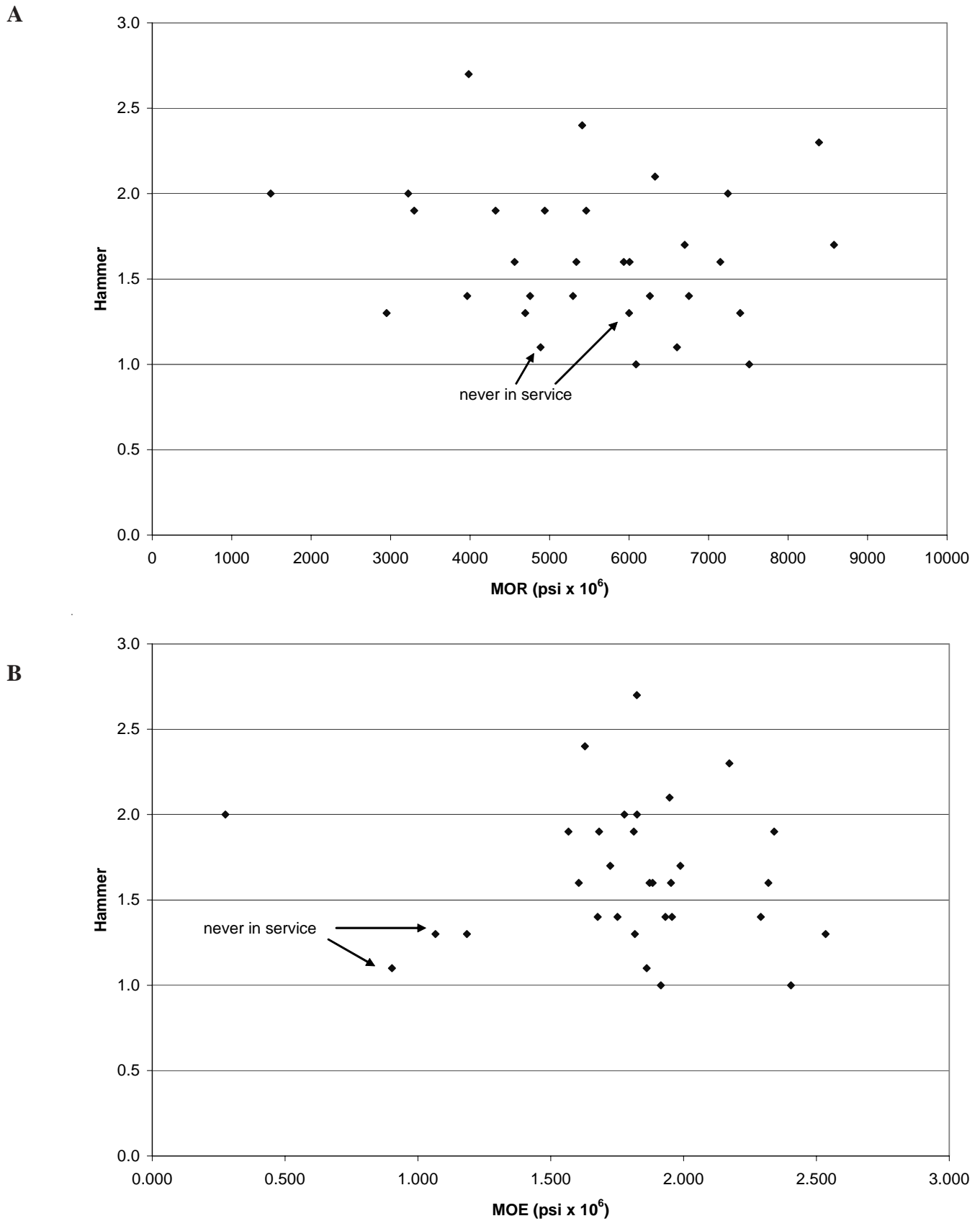
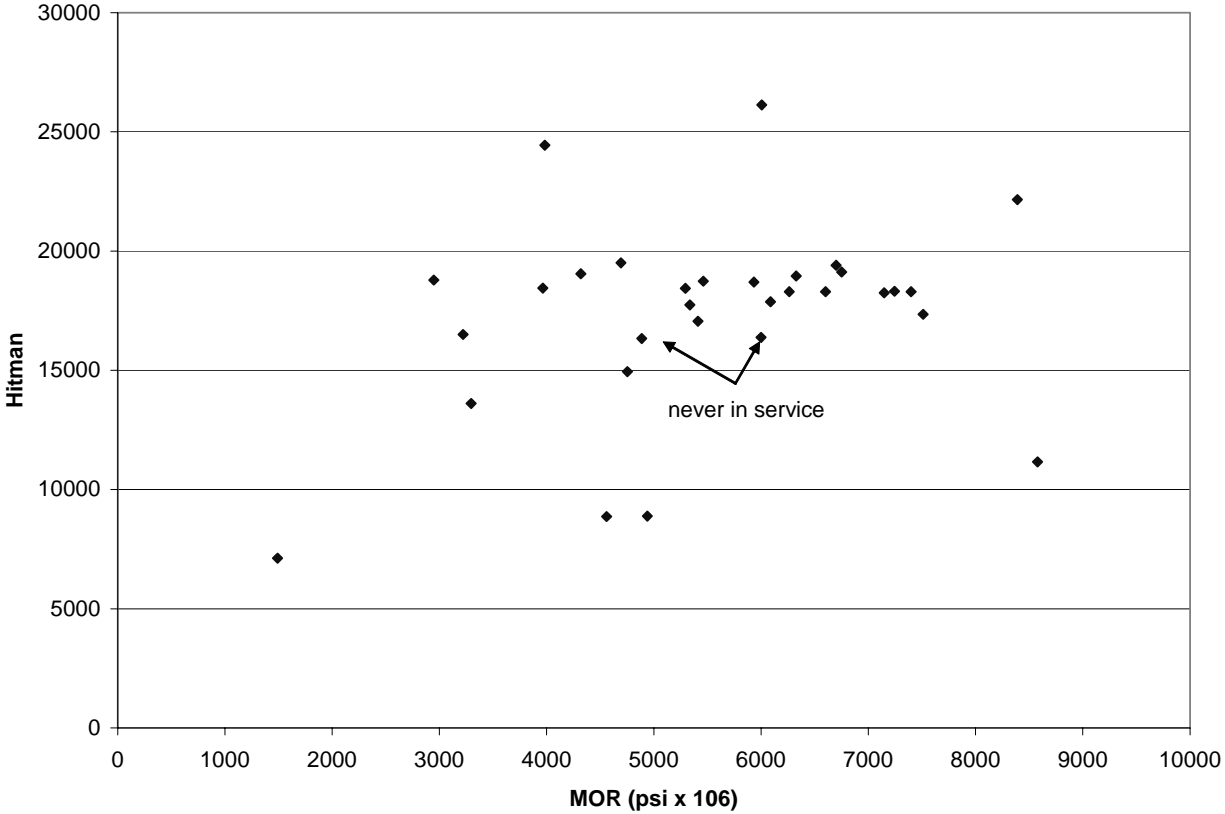

Figure III-25. Relationship between non-destructive assessments using an MK-4 Hammer and a) MOR or b) MOE of Douglas-fir cross arms removed after 45 to 60 years of exposure.

A



B

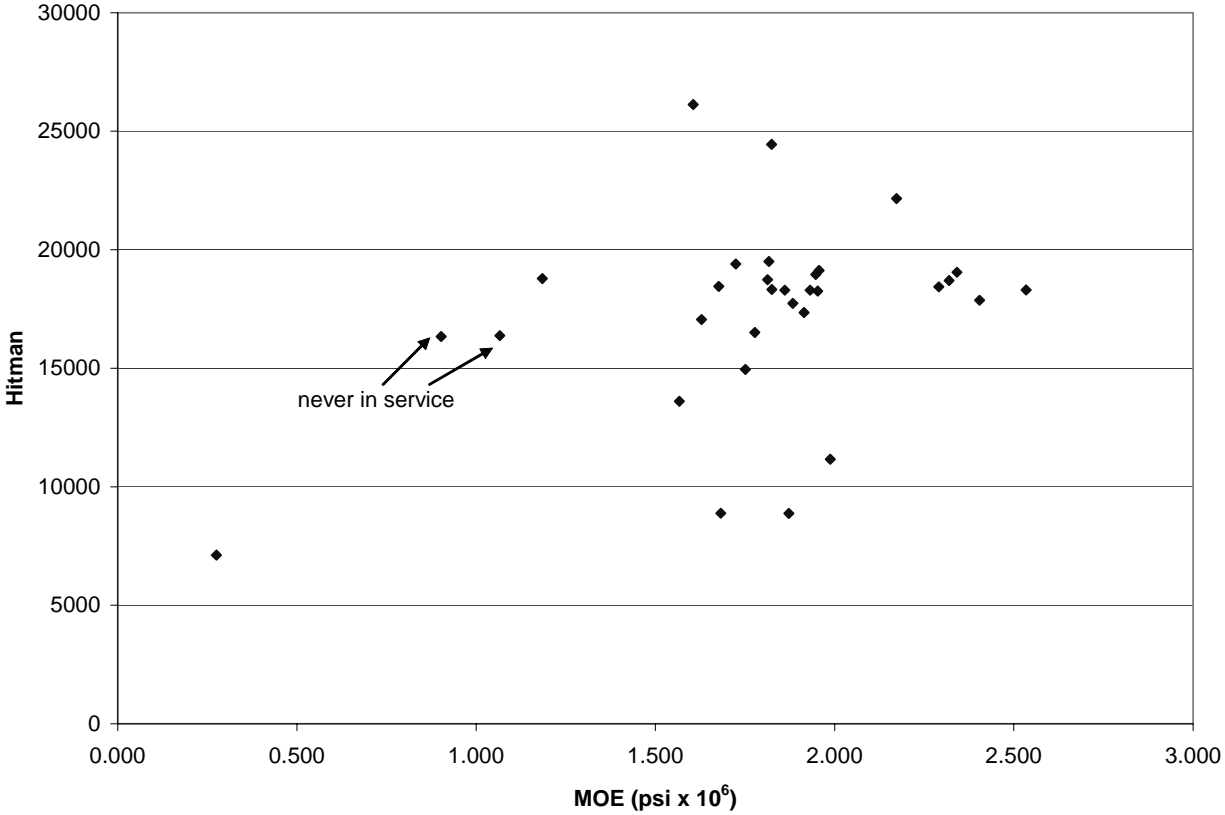

Figure III-26. Relationship between non-destructive assessments using the Hitman and a) MOR or b) MOE of Douglas-fir cross arms removed after 45 to 60 years of exposure.

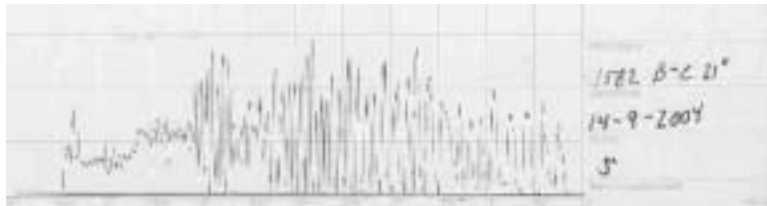
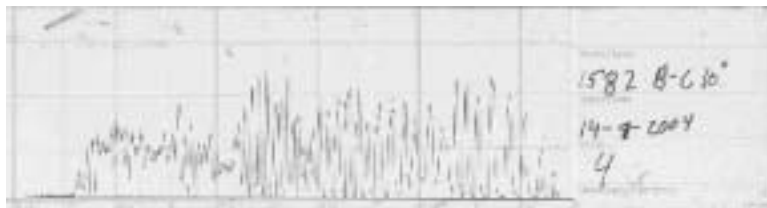
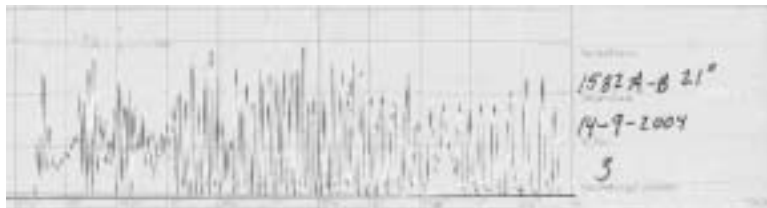
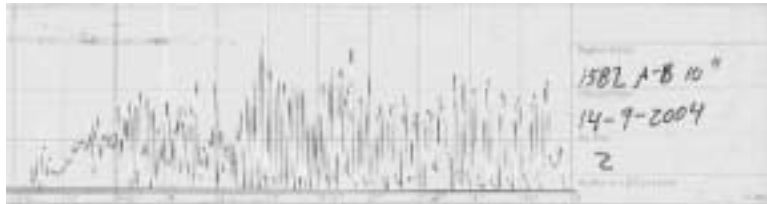
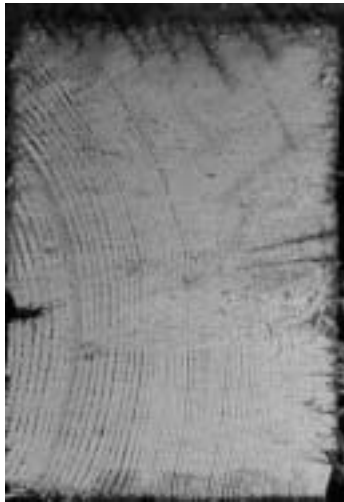
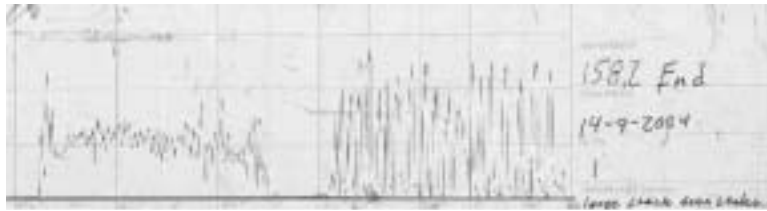
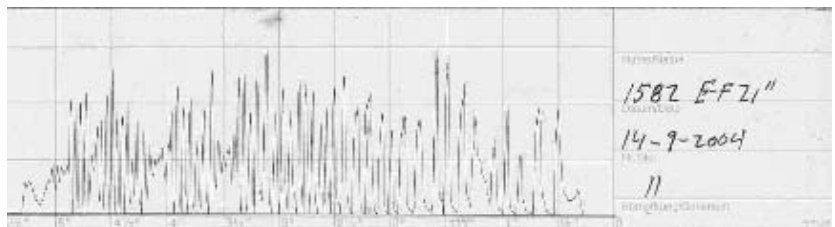
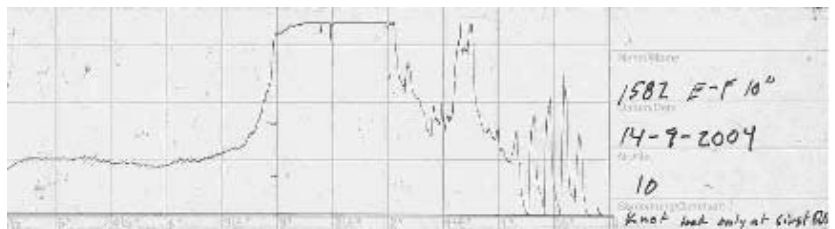
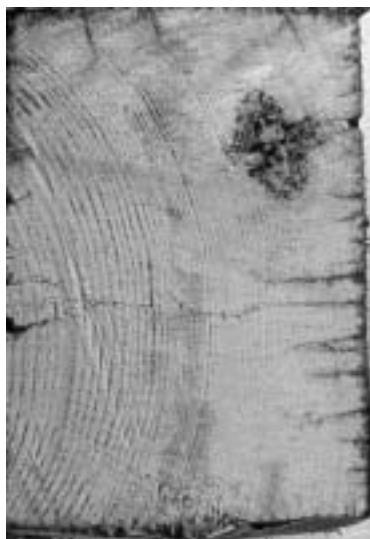
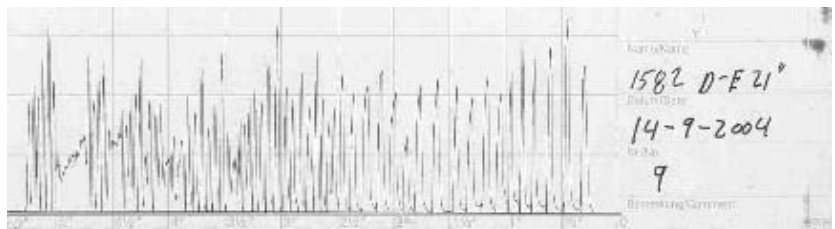
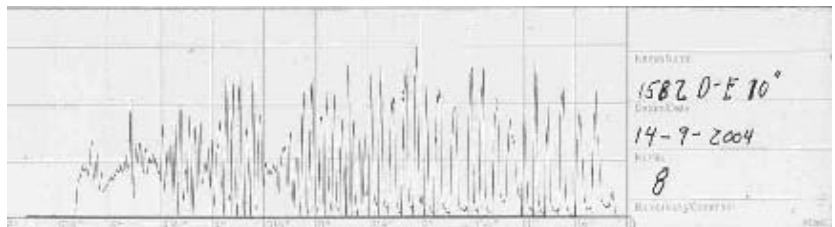
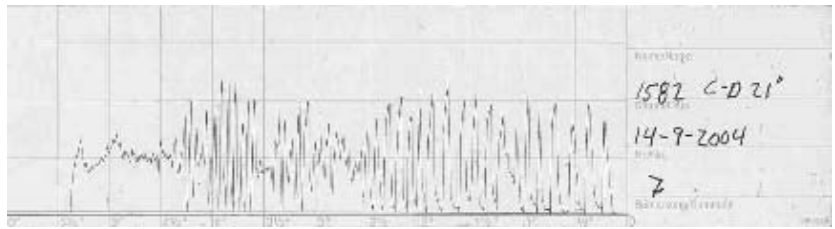
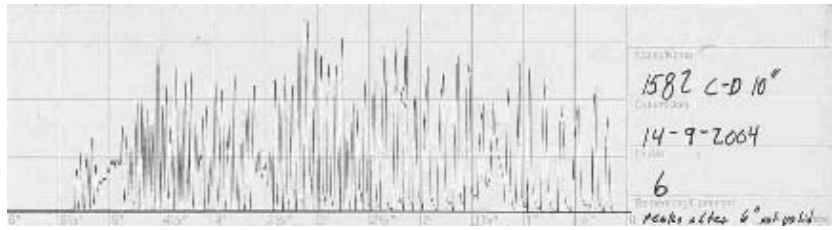
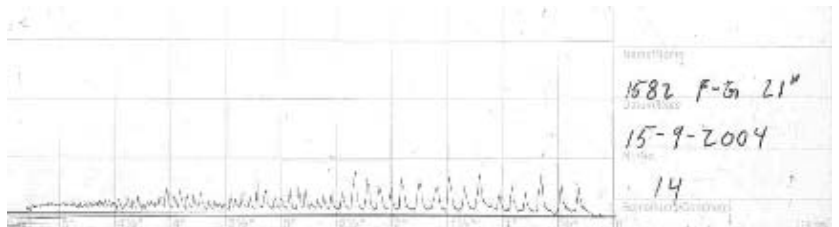
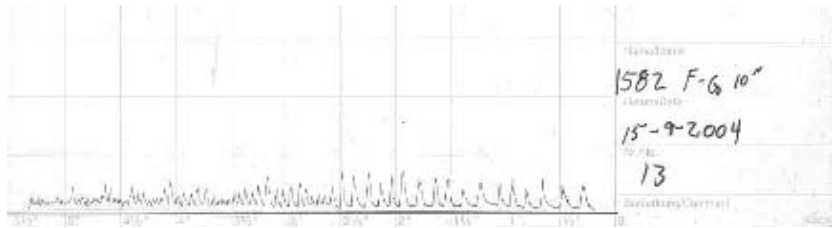
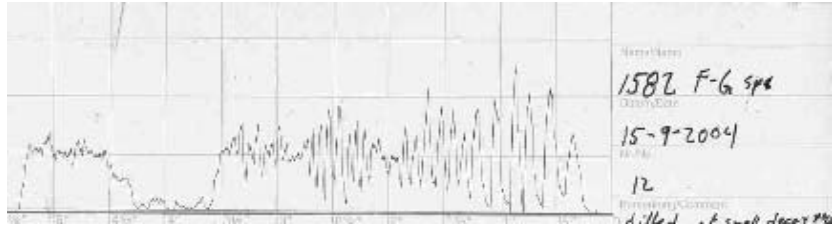
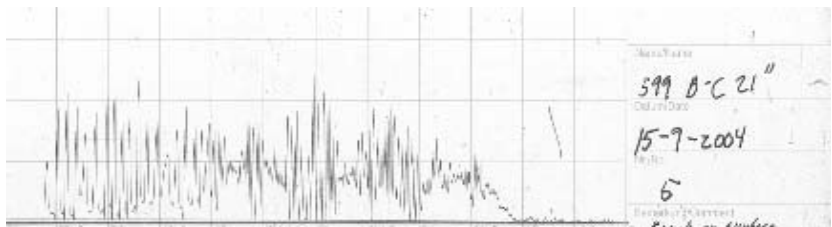
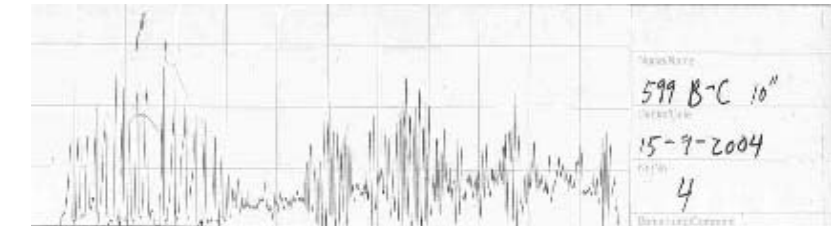
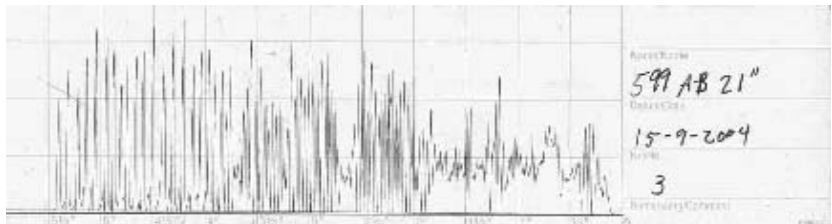
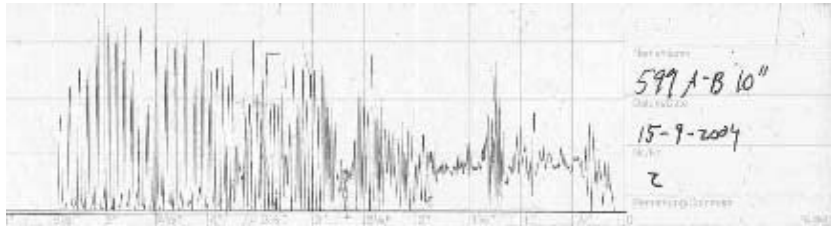
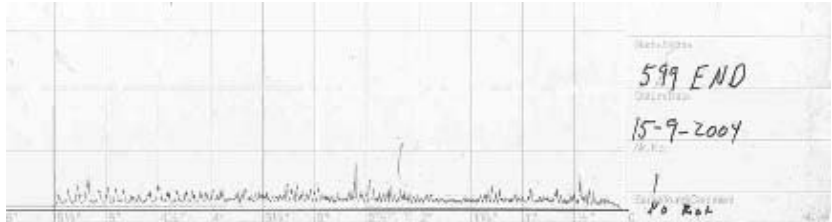

Figure III-27. Comparisons between visual examination of cross sections cut from three Douglas-fir cross arms and Resistograph output from either immediately adjacent to the cross section or mid-way between sections. Arm #1582 had a small decay pocket, arm #599 had severe internal decay and arm #586 had no evidence of visible decay.









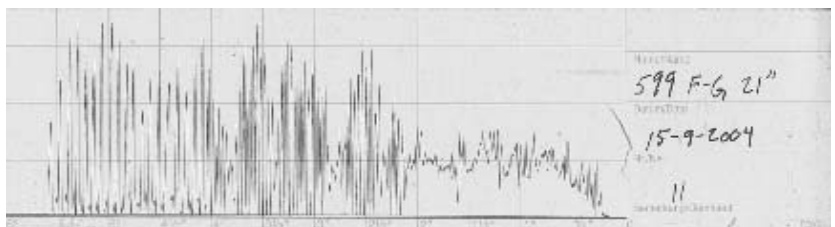
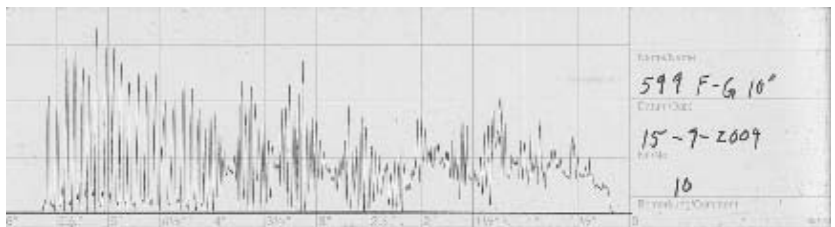
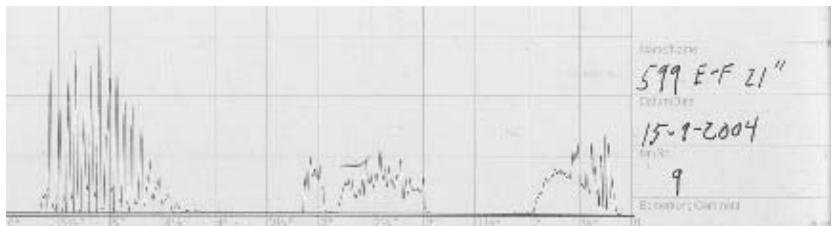
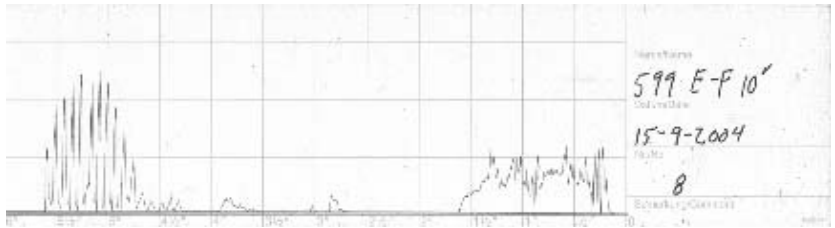
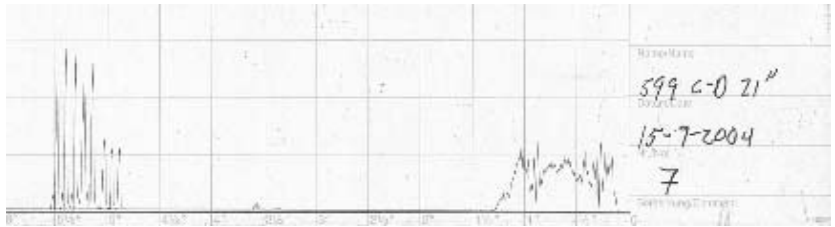
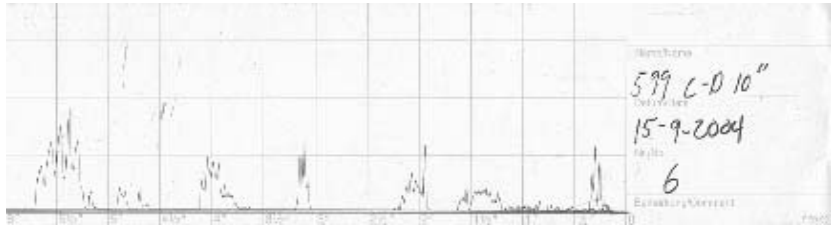

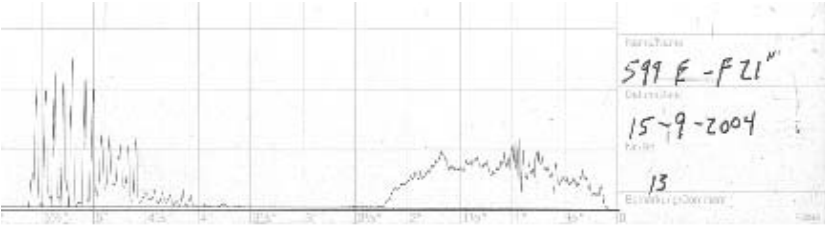
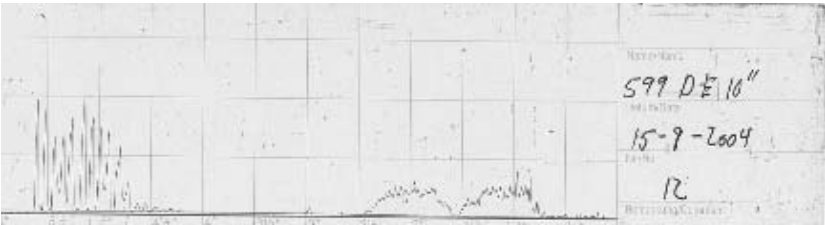



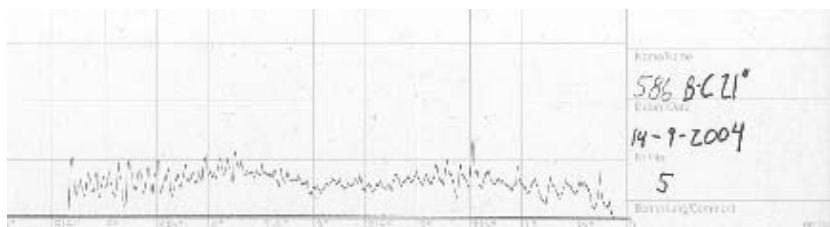
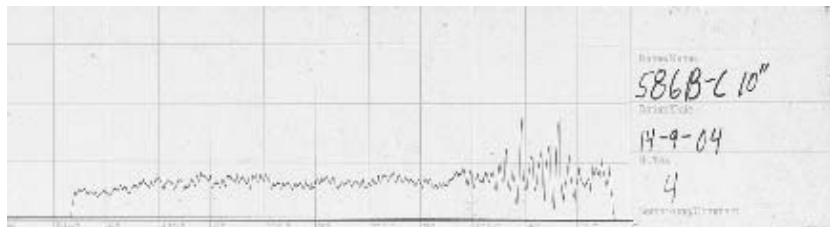
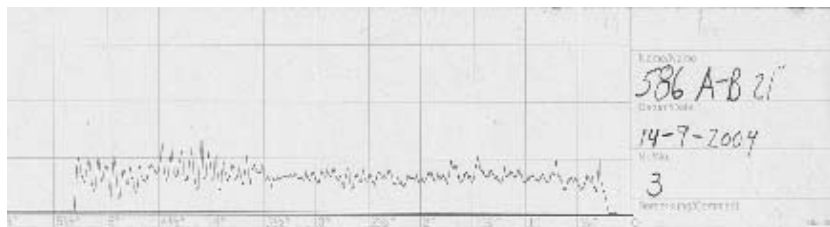
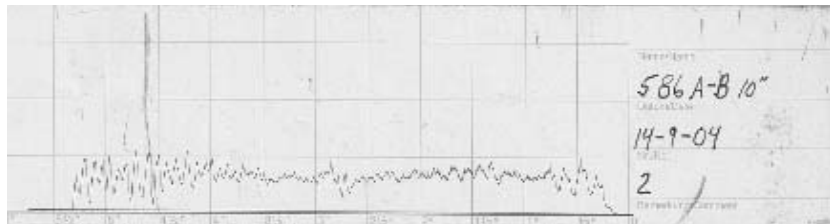
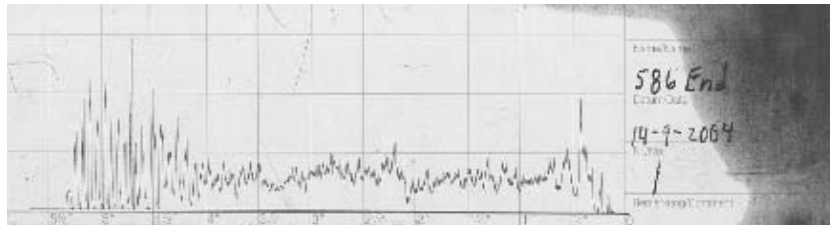

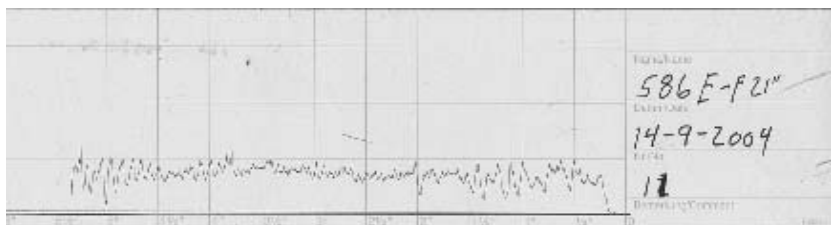
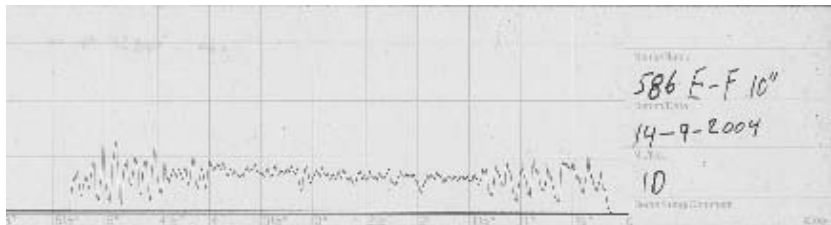
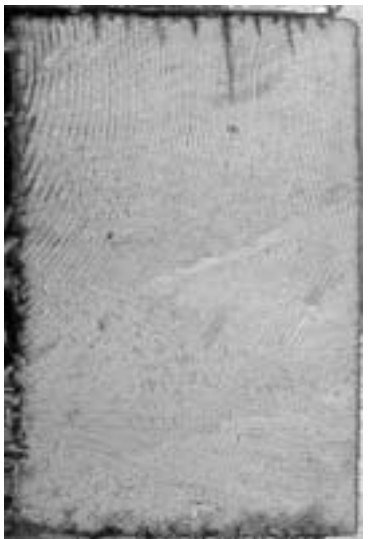
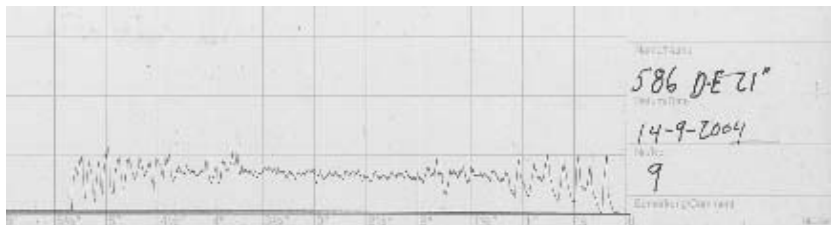
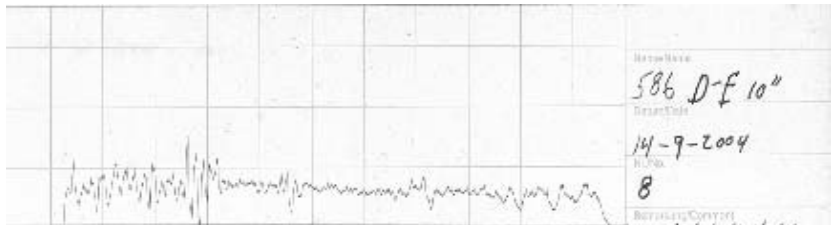
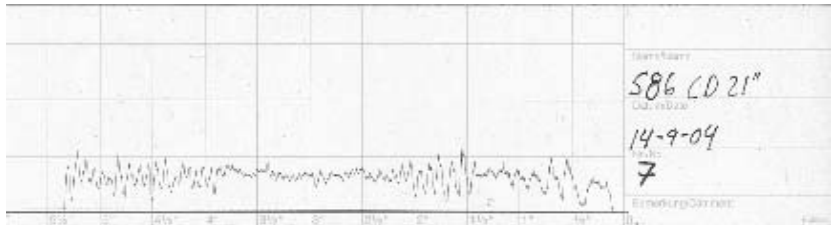
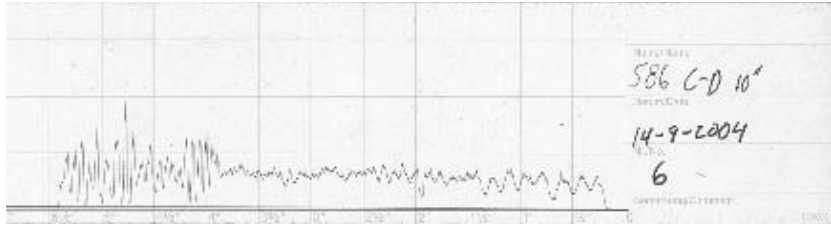

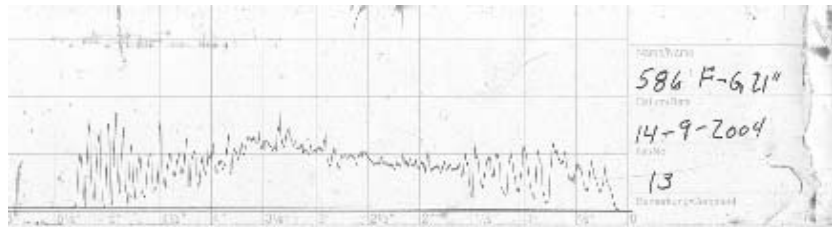
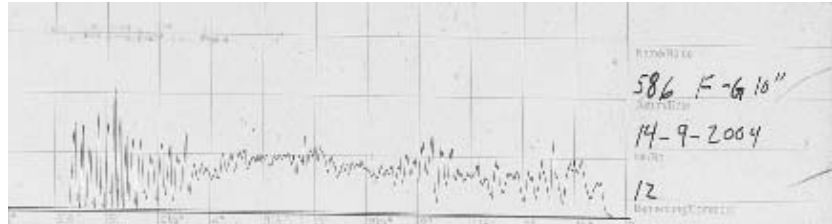

Dissection of the crossarms revealed that the vast majority of arms had no visible evidence of advanced decay (Figure III-28). These results are consistent with the isolation studies of the larger field population, which showed little or no evidence of fungal attack. Preservative treatment was generally shallow along the faces, although cuts near bolt holes indicated that arms had been pre-drilled prior to treatment. Pre-drilling may be one reason for the low levels of fungal decay after such prolonged service. Only one arm (#599) contained advanced decay and this decay was also clearly evidenced by the much lower bending properties exhibited by this arm.

The results indicate that cross arms have experienced considerable physical degradation but relatively little biological degradation over the 45 to 60 years of service. While the exterior damage can clearly reduce the effective section modulus of the arms, a majority of the arms tested still exceed the 67 % residual strength requirement and a number of others were very close to this limit. It is difficult to interpret how to apply these data to the specific configuration without additional knowledge about the deadloads, ice loading and wind criteria, and the safety factors used by the cooperator. NDE tests detected the weakest arm, but also tended to reject other arms that retained acceptable residual strength. These results imply that the NDE tools assessed were probably not suitable for this application. Further tests are underway on several other non-destructive testing methods.



Crossarm # 586

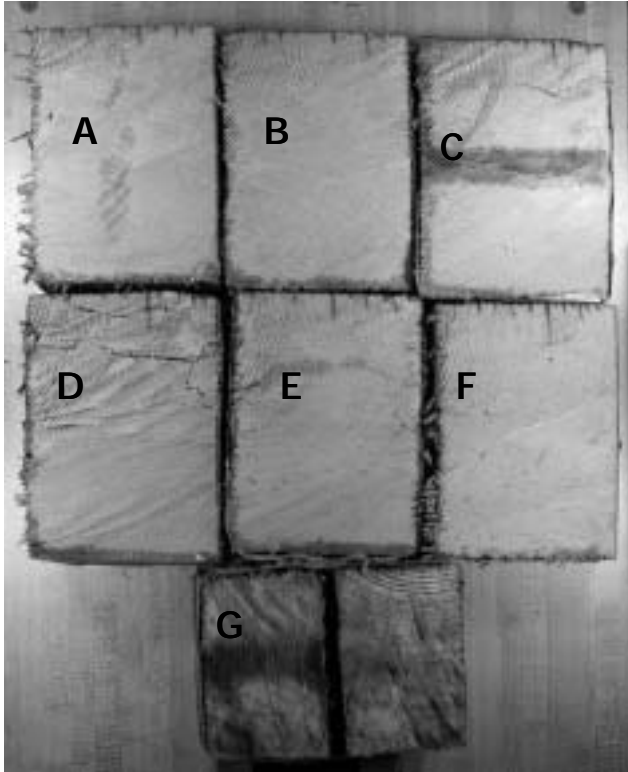

Crossarm # 587

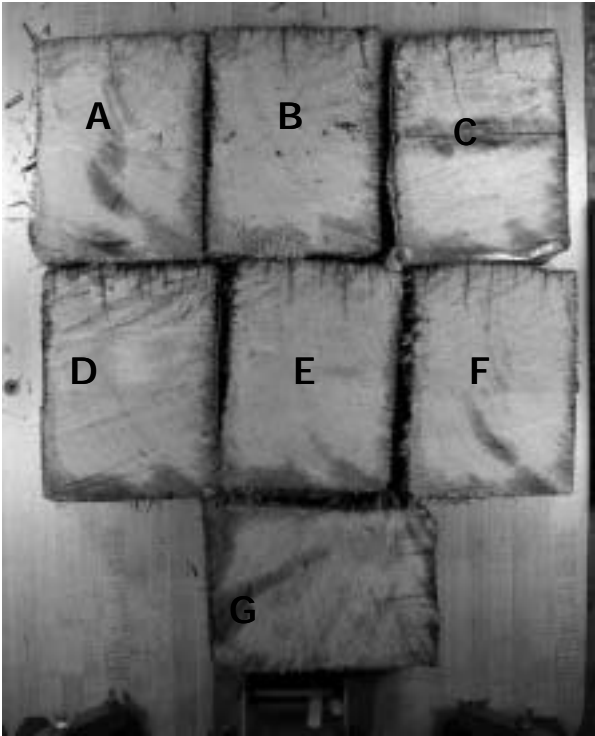

Crossarm # 588

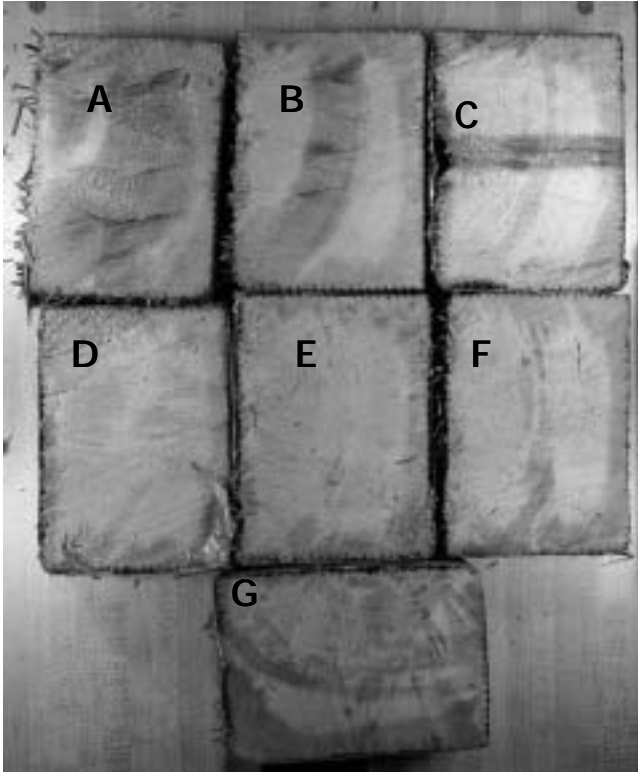

Crossarm # 589

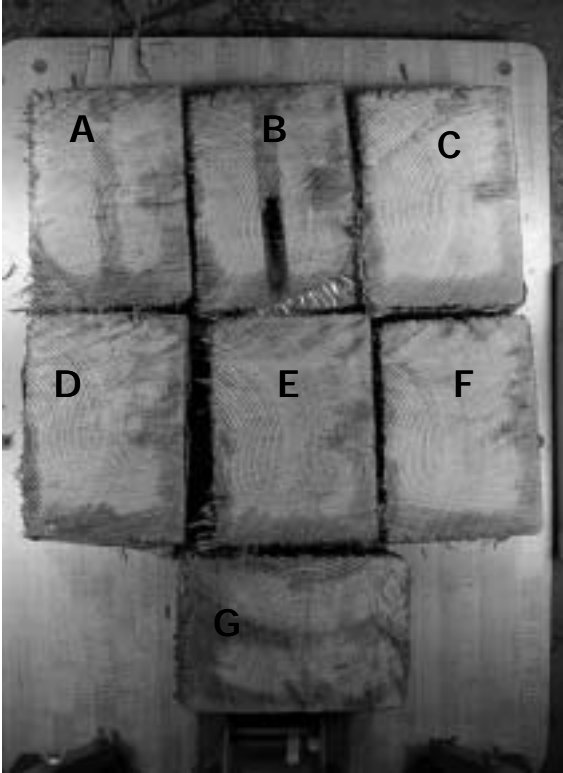
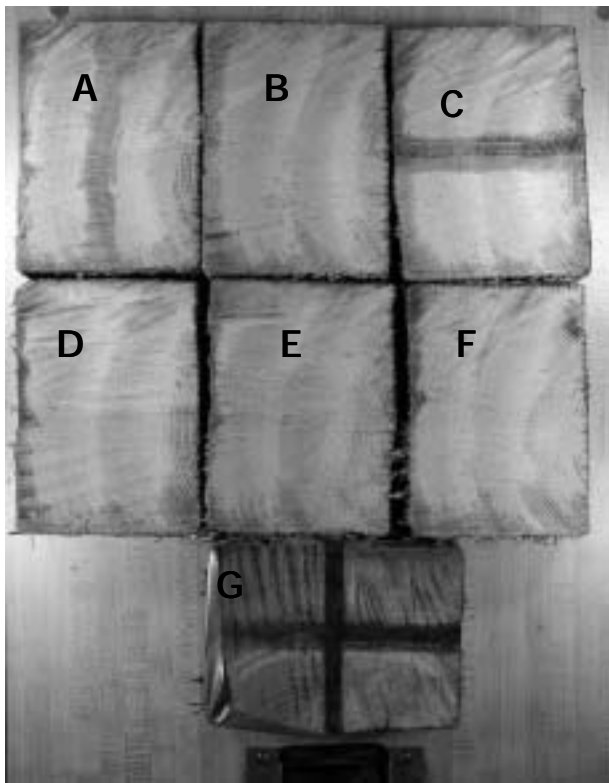
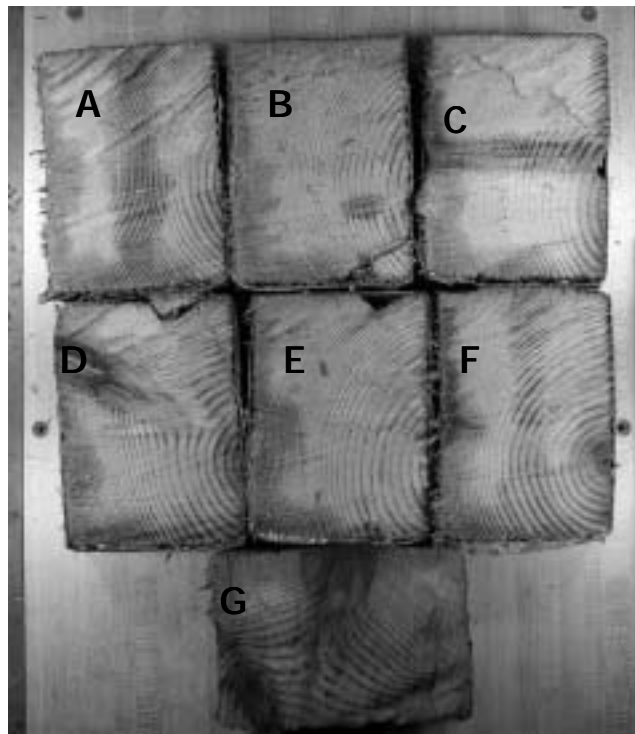

Figure III-28. Cross sections cut at 0.6 m intervals from pentachlorophenol treated Douglas-fir cross arms in service for 45 to 60 years.

Crossarm 590



Crossarm 591



Crossarm 593

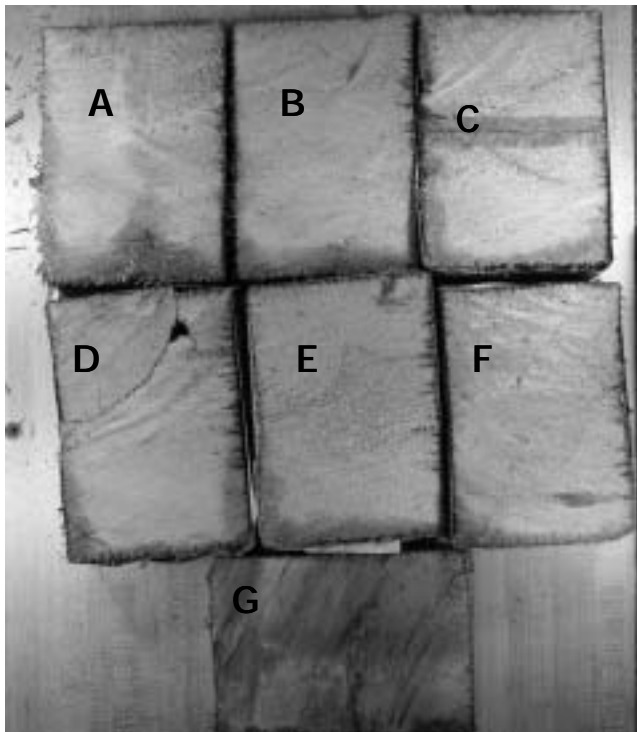

Crossarm 593

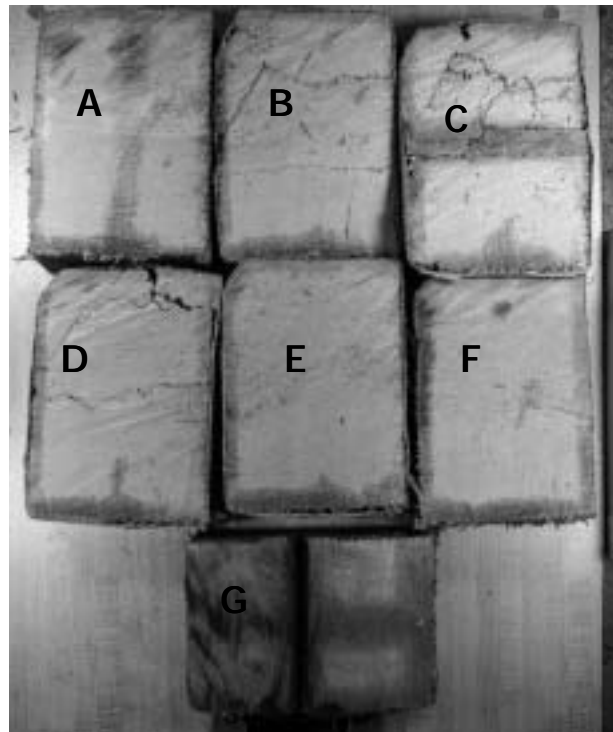

Crossarm 594

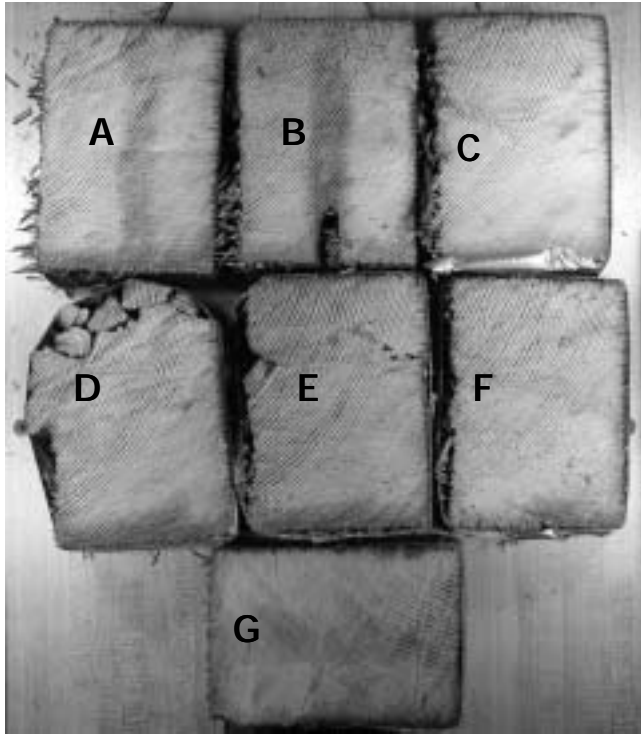

Crossarm 595

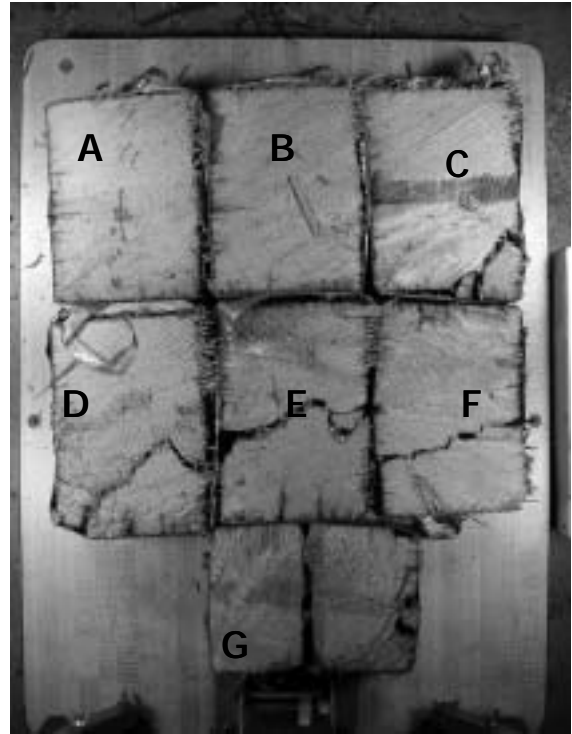

Crossarm 596

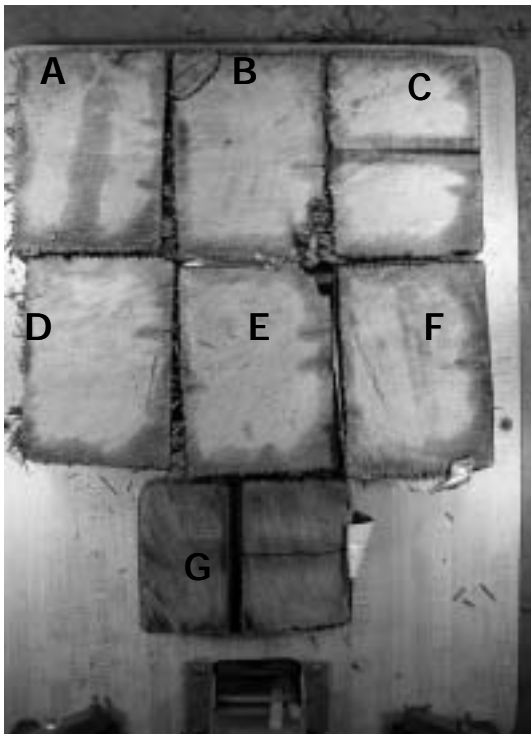

Crossarm 597

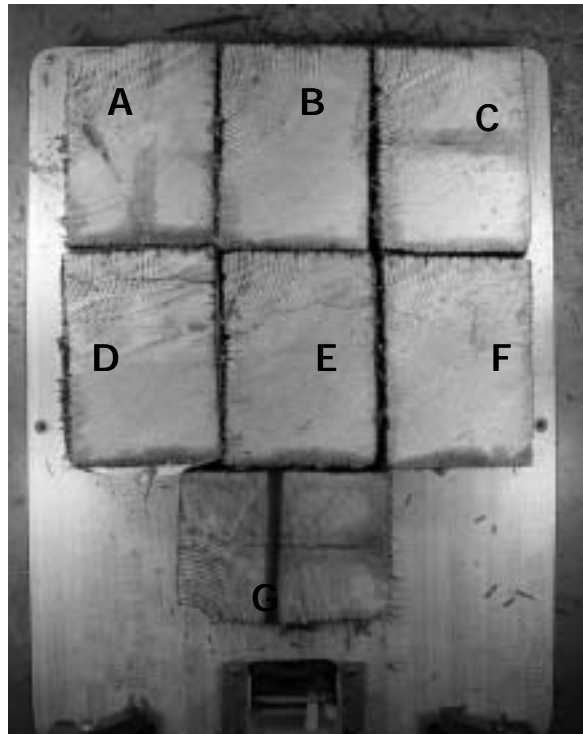



Crossarm 598

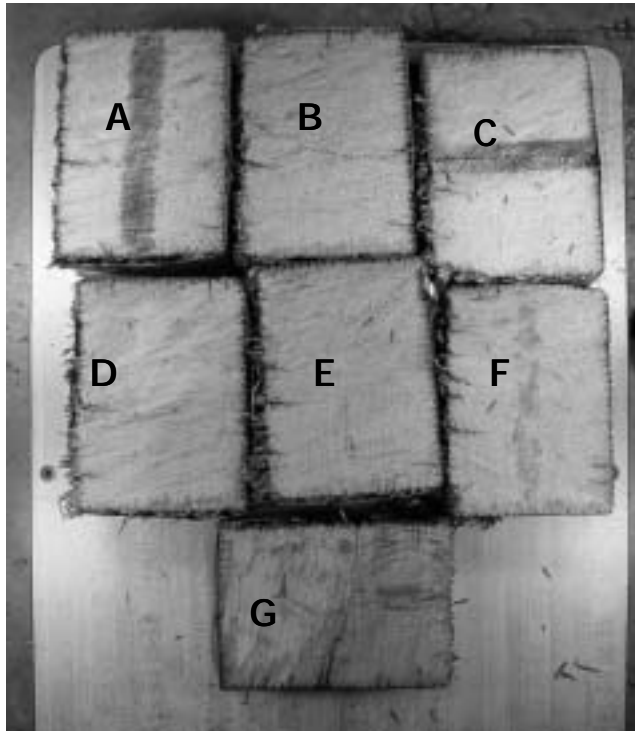

Crossarm 600

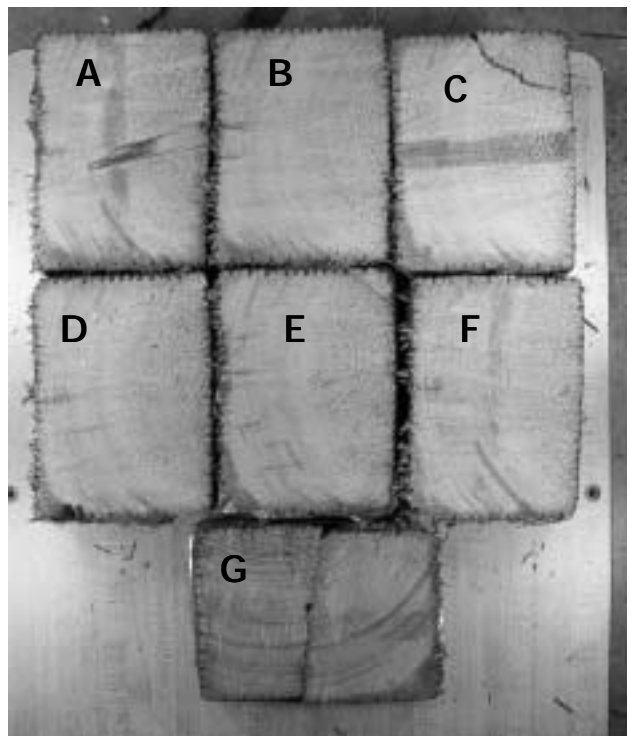

Crossarm 1582

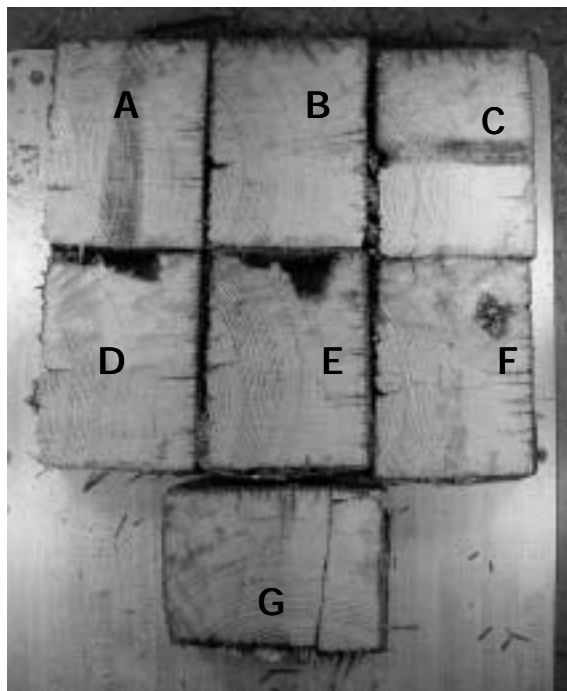

Crossarm 1583

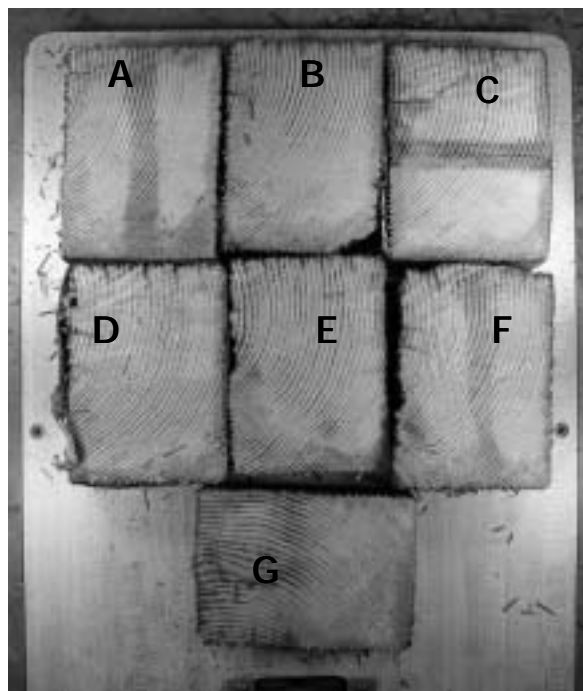

Crossarm 1584

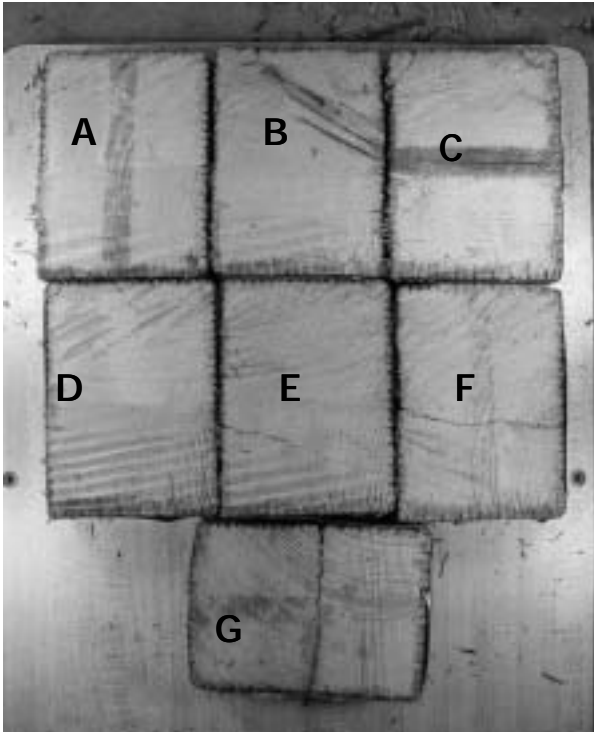

Crossarm 1586

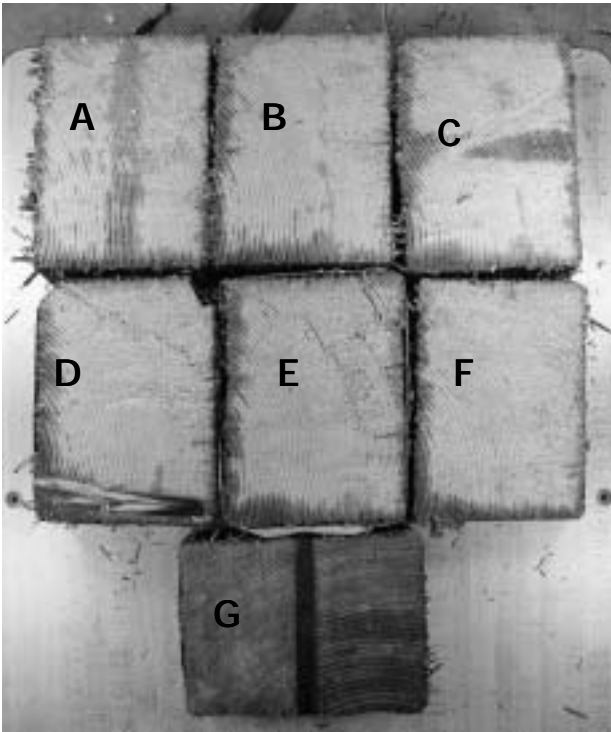

Crossarm # 1587

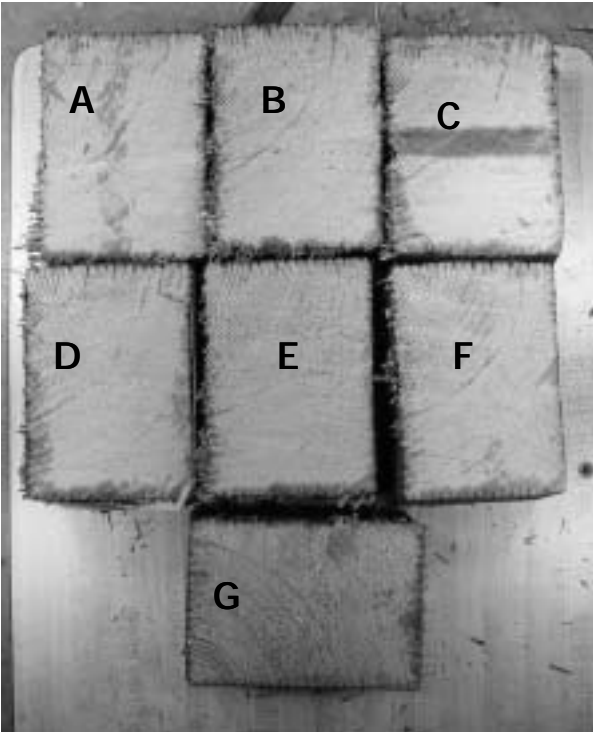

Crossarm # 1588

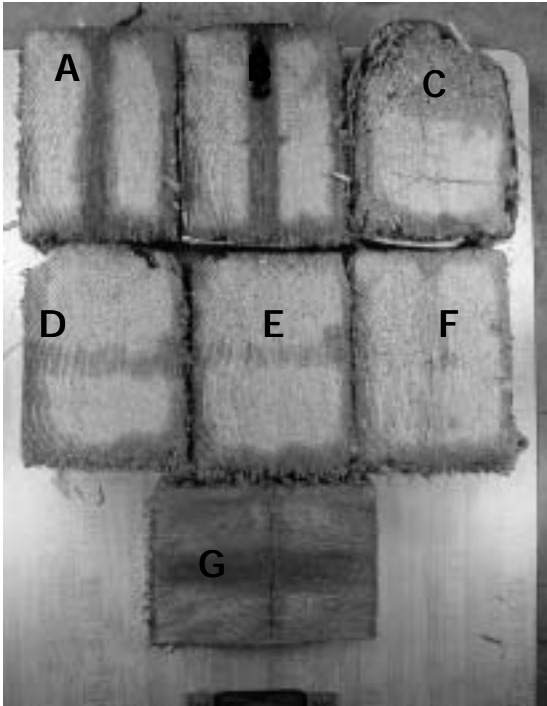

Crossarm # 1589

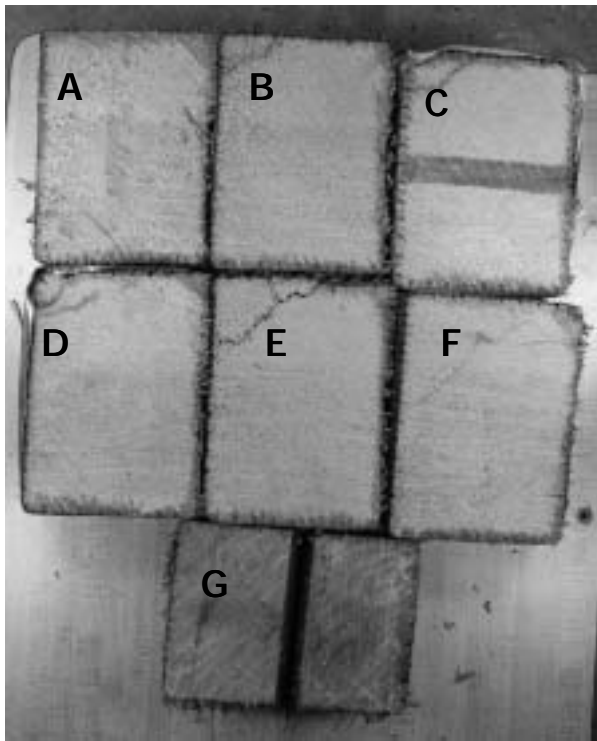

Crossarm # 1590

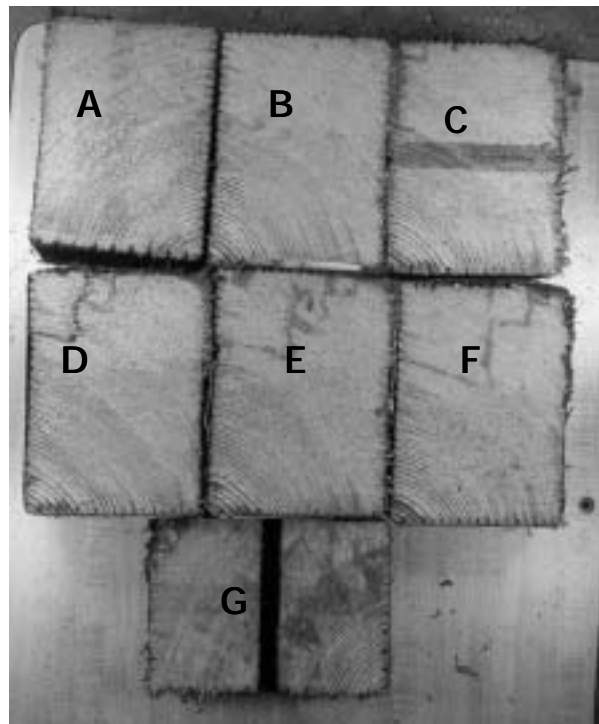

Crossarm # 1591

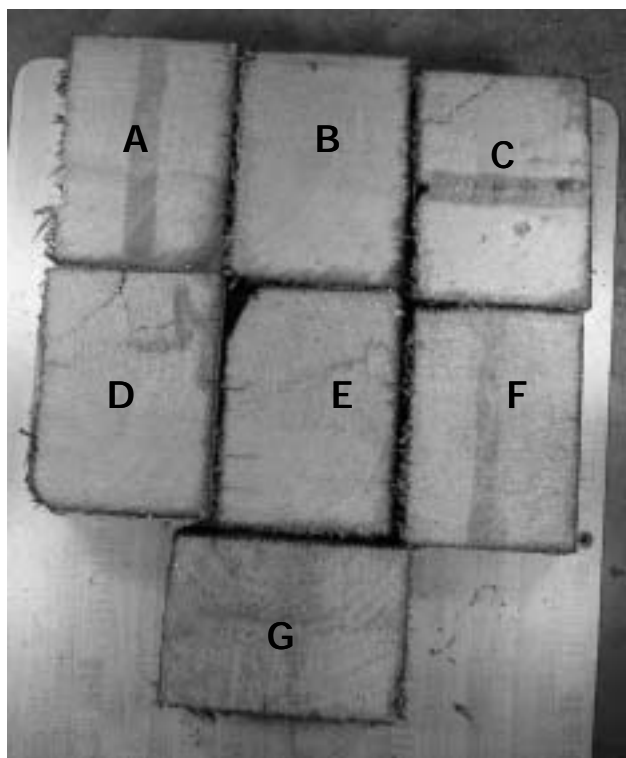

Crossarm 1592

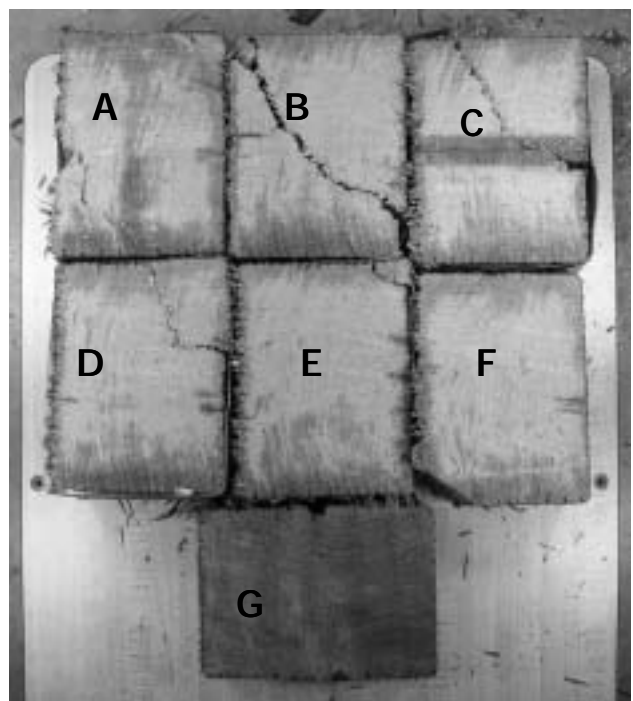



Crossarm # 1593

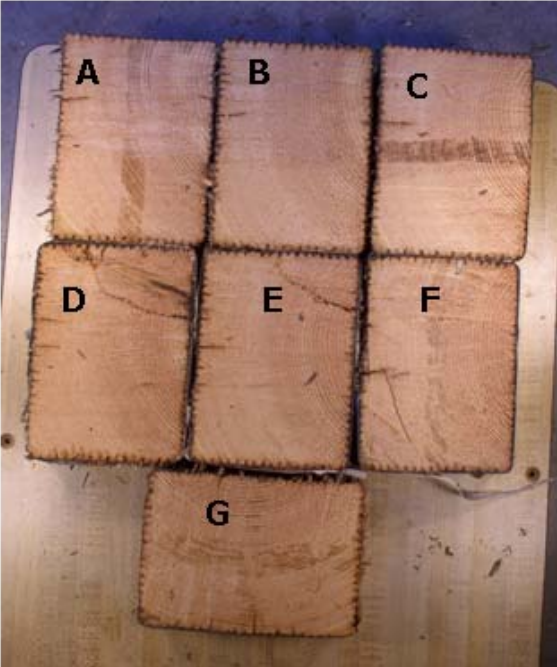

Crossarm # 1594

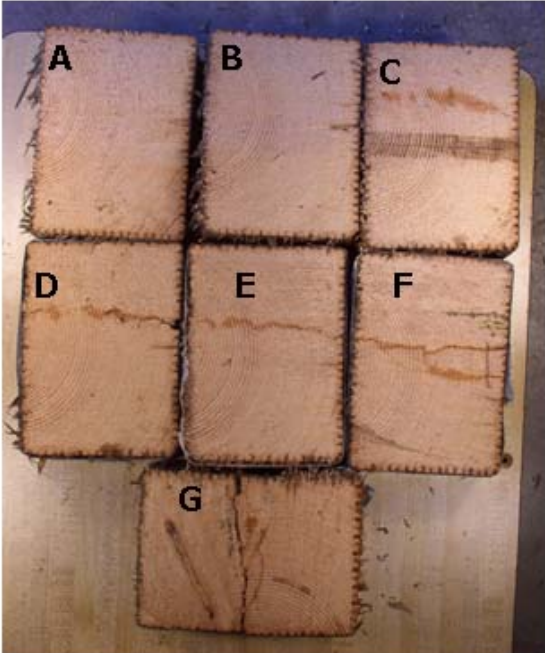

Crossarm #1595

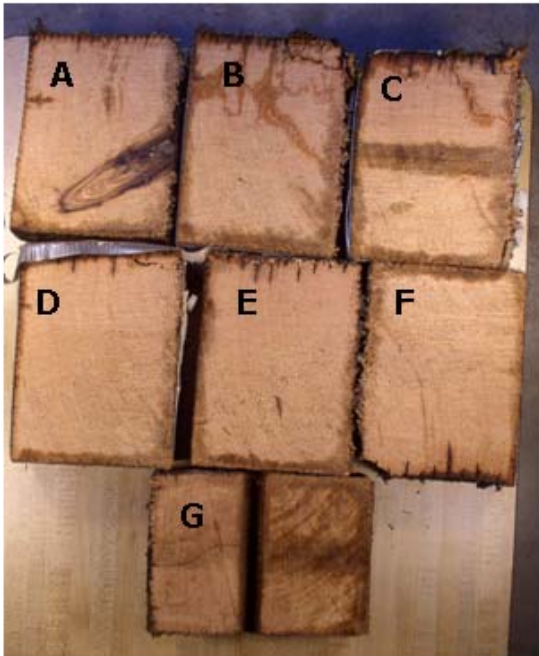

Crossarm # 1596

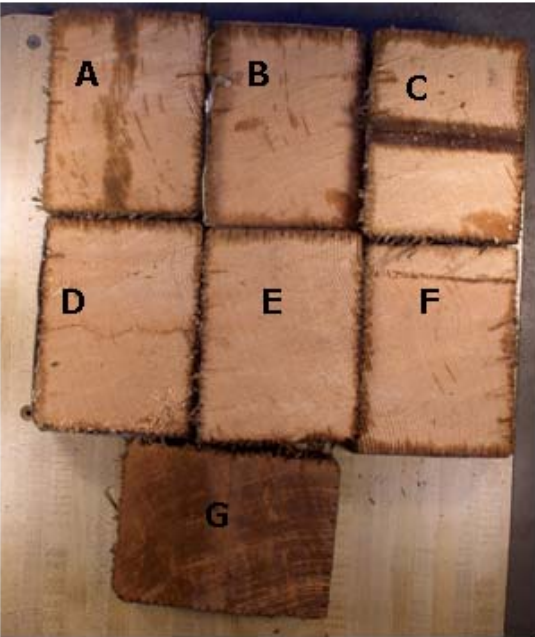

Crossarm # 1597

New

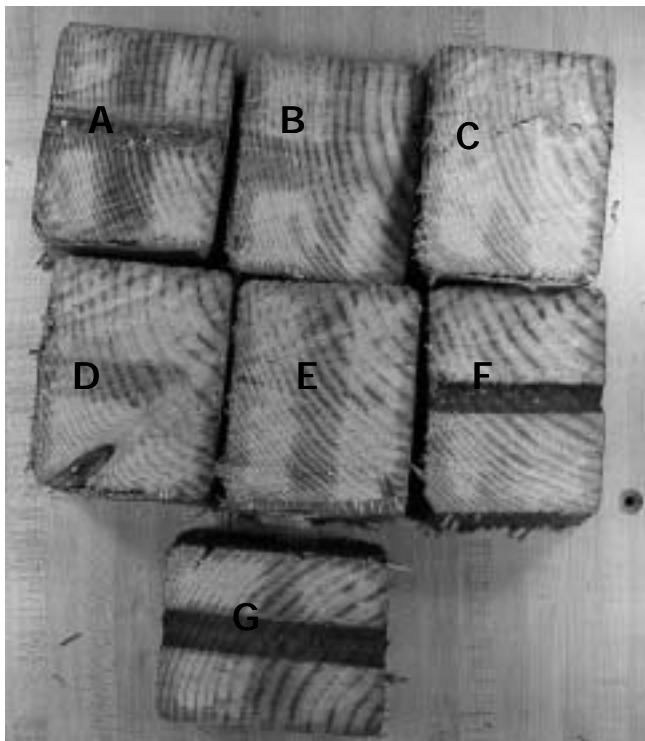

Crossarm # 1598

New

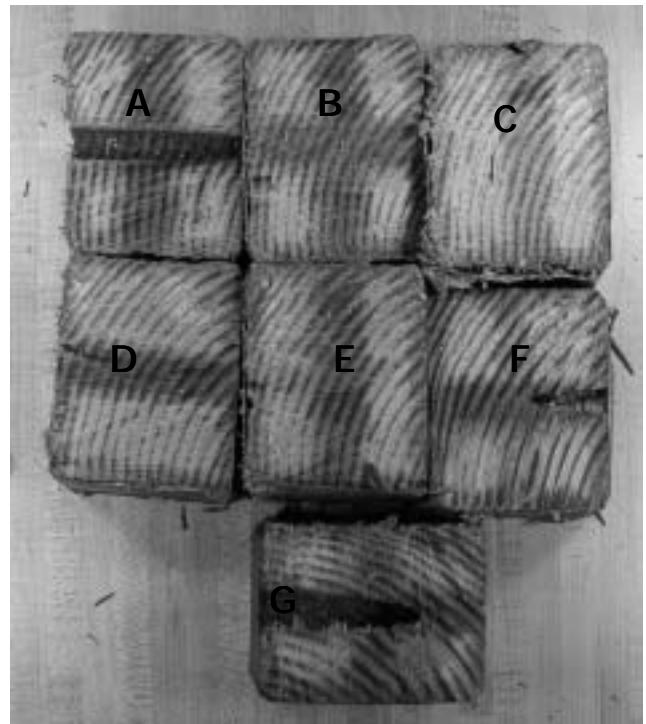

Crossarm # 599

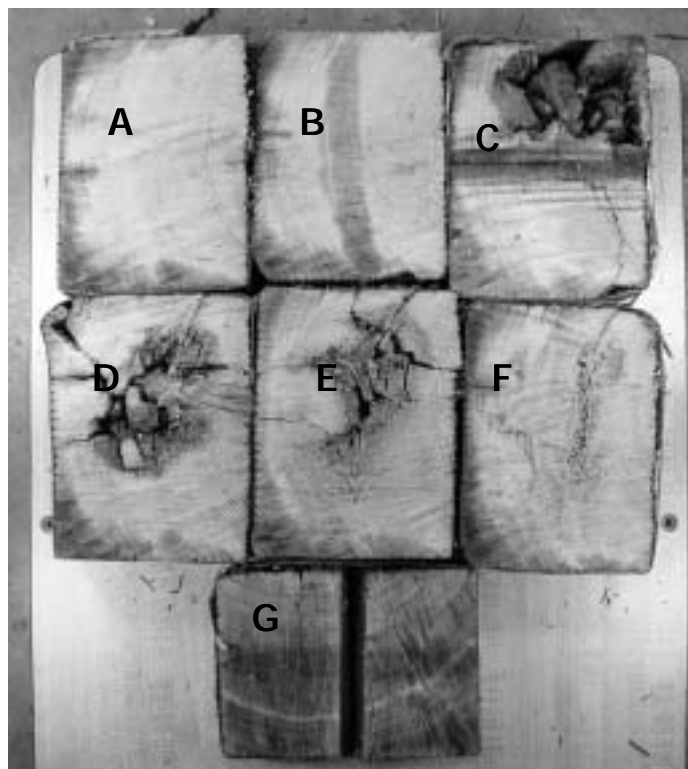



---

---

### **C. Assessment of Bending Tests and Ground Penetrating Radar for Assessing Residual Strength of Western Redcedar Poles**

Last year, we reported on the initiation of a test to assess several promising new tools for non-destructively assessing residual strength in standing utility poles. The Mechanical Pole Tester was developed in Australia for assessing eucalyptus poles and uses flexural response to calculate a residual pole capacity based upon specific input criteria for each pole (circumference, configuration, etc.). Ground penetrating radar uses radar energy to assess the internal condition of a pole. The devices were assessed on a set of western redcedar transmission poles in service near Spokane, Washington. The poles were scheduled for removal because of a line upgrade. The original field testing was completed last year, but pole removal was delayed for many months because the contractor had not yet reached the poles in question. The poles were removed this past summer; however, for unknown reasons, only six poles arrived in testable condition. These poles will be tested in bending this coming Fall and the results will be compared with those obtained using the two non-destructive measurements. The results will be included in the next annual Report.

### **D. Ability of External Pole Barriers to Limit Moisture Ingress Into Copper Naphthenate and Pentachlorophenol Treated Western Redcedar Poles**

The groundline has long been recognized as the critical decay zone of poles in most regions of the country owing to the presence of elevated moisture levels and an abundance of wood degrading organisms. One approach to extending service life would be to protect this zone using synthetic barriers that restricted moisture and microbial access to the wood. A number of systems have been developed for this purpose. For example, the Port of Los Angeles experimented with a polyurethane coating to protect piling from marine borer attack, but these systems were never commercialized. Recently, however, the increasing concerns about the risk of preservative leaching from the poles into the surrounding soil have encouraged renewed interest in these systems, both for protecting the wood and limiting preservative migration. One system is currently used by a utility in Washington State and others are being considered. There are, however, limited reports on the ability of these systems to restrict moisture uptake. This past year, we initiated a test in cooperation with JH Baxter to examine moisture sorption characteristics in western redcedar poles protected with two of these barrier systems.

Western redcedar pole sections (200-250 mm in diameter by 2.4 m long) were treated with either pentachlorophenol or copper naphthenate in P9 Type A oil. The copper naphthenate was applied using a thermal process while the penta was applied using a pressure cycle. The poles were then wrapped with either the Biotrans barrier originally developed in South Africa or the UPC coating. The Biotrans materials were all applied with a closed end on the butt. This seal was not complete, but it should presumably restrict moisture sorption from the surrounding soil. The UPC samples were applied with the ends open. The samples were either exposed in water from their butts to just below the tops of the barrier or they were buried in soil to a similar depth in large tanks maintained at 23-25 C in our testing laboratory. The soil was regularly watered to maintain moisture conditions, but every effort was made to limit the potential for wetting above the groundline so we could assess the potential influence of soil or water contact on the lined zones of the poles.

Prior to setting, the moisture content of each pole was sampled at the butt, 80 cm, and 140 cm above the butt by removing increment cores from two sides of each pole. These cores were divided into zones corresponding to 0-13, 13-25, 25-50, and 50-75 mm from the surface. These cores segments were weighed, then oven dried and reweighed to determine wood moisture content. In addition, each pole was weighed. Moisture content was monitored 4 weeks after immersion or setting in soil by removing increment cores from locations adjacent to the original sampling sites. These

cores were processed as described above. The poles were also weighed at this time to determine total moisture uptake.

Moisture contents of the samples at the time of immersion were fairly uniform, ranging from 16 to 24.8 % and there appeared to be little difference in moisture level with distance from the surface (Figures III-29-37) (Table III-4). Moisture levels were slightly elevated in some Biotrans wrapped poles 80 cm inches above the butt, but it was unclear why these particular poles had slightly higher moisture contents prior to moisture exposure.

Moisture contents for all poles had risen dramatically 4 weeks after immersion, particularly near the surface at the butt 4 weeks after immersion or setting. Moisture contents in the outer 13 mm in uncoated poles were 196 and 239 % when exposed to water or soil, respectively. Moisture contents declined slightly further into the poles, but were still well above 100 %. Moisture contents were similarly high at the butt for the untreated pole wrapped with the UPC system. These elevated moisture levels in untreated wood illustrate the value of the oil-borne preservative as a water repellent. Moisture levels in oil copper naphthenate treated poles with the UPC wraps increased slightly (42 or 46 % in the outer zone), but these levels were far lower than those found with the untreated wood.

Moisture contents further upward from the butt also increased slightly, but this effect was largely limited to the outer 13 mm. Moisture levels 140 cm above the butt were similar to the starting moisture values, indicating that the barriers were effective in this region. The gradual moisture movement upward from the butt would suggest that eventually, the moisture levels in the entire barrier zone will become elevated. Elevated moisture levels could be a benefit were they to rise to the point where oxygen was limiting and fungal growth was limited. However, moisture levels below inhibitory levels could provide ideal conditions for the development of internal decay.

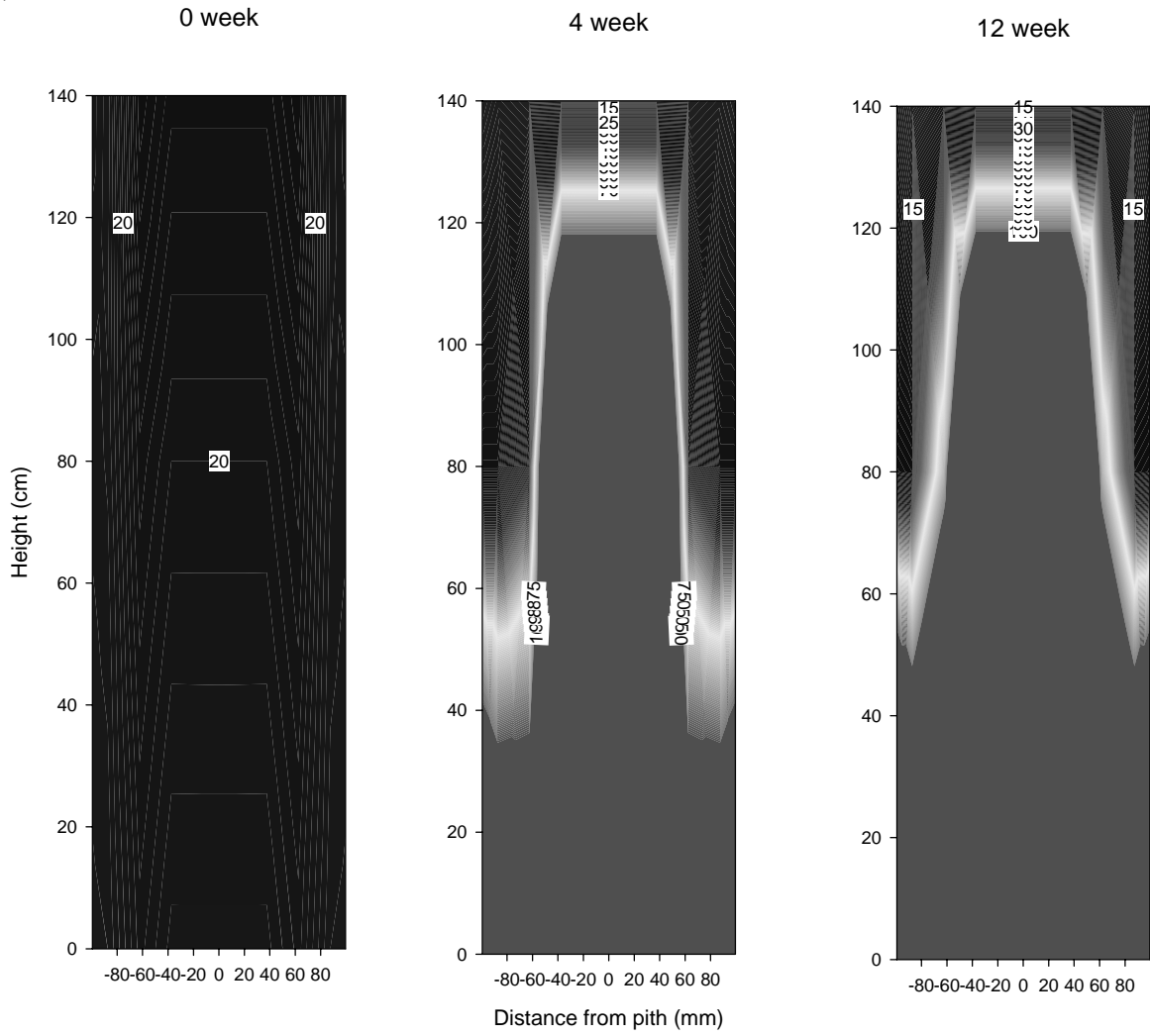

Figure III-29. Moisture contents of untreated western redcedar poles immersed in water for 0 to 12 weeks.

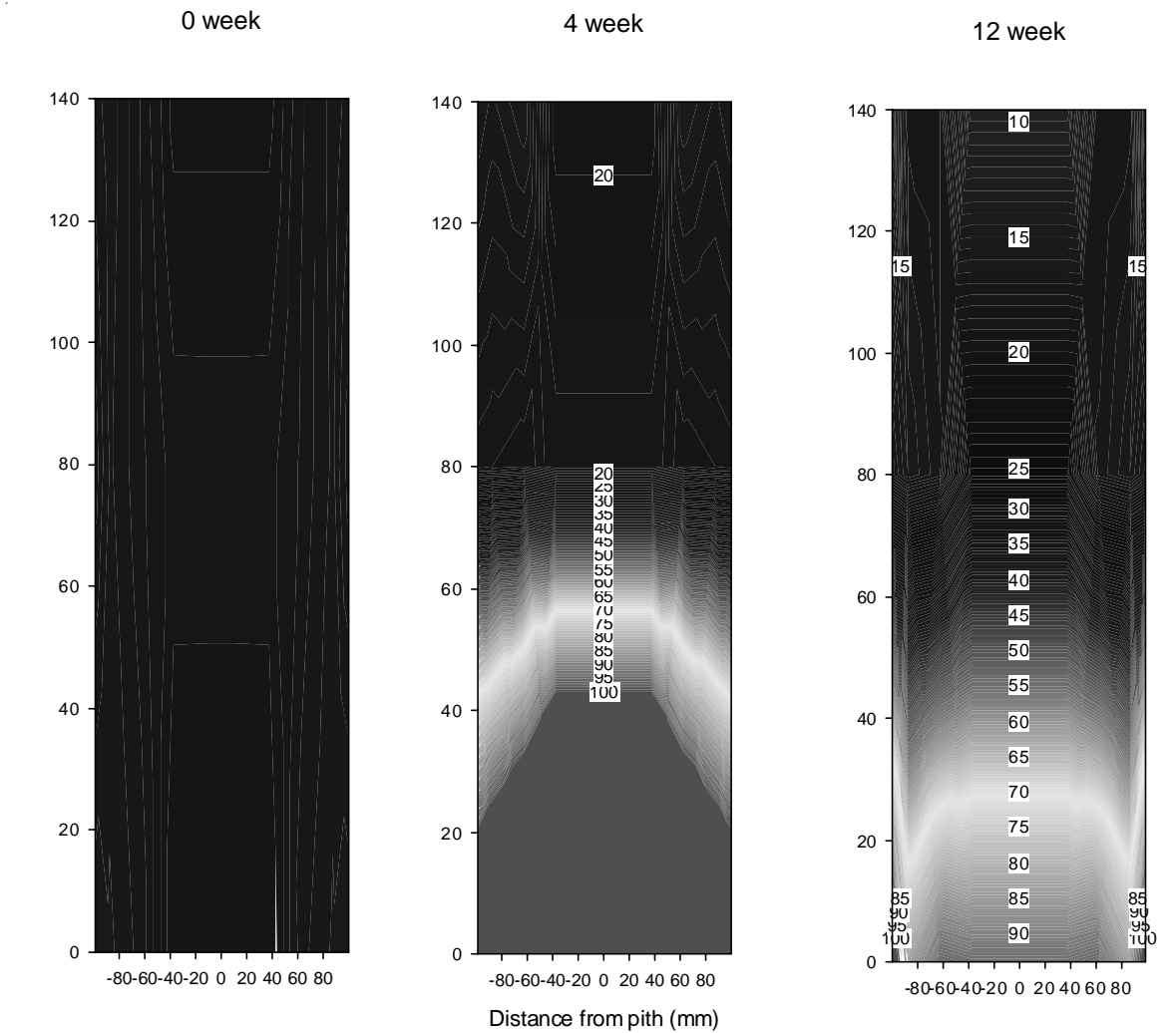

Figure III-30. Moisture contents of untreated western redcedar poles immersed in moist soil for 0 to 12 weeks.

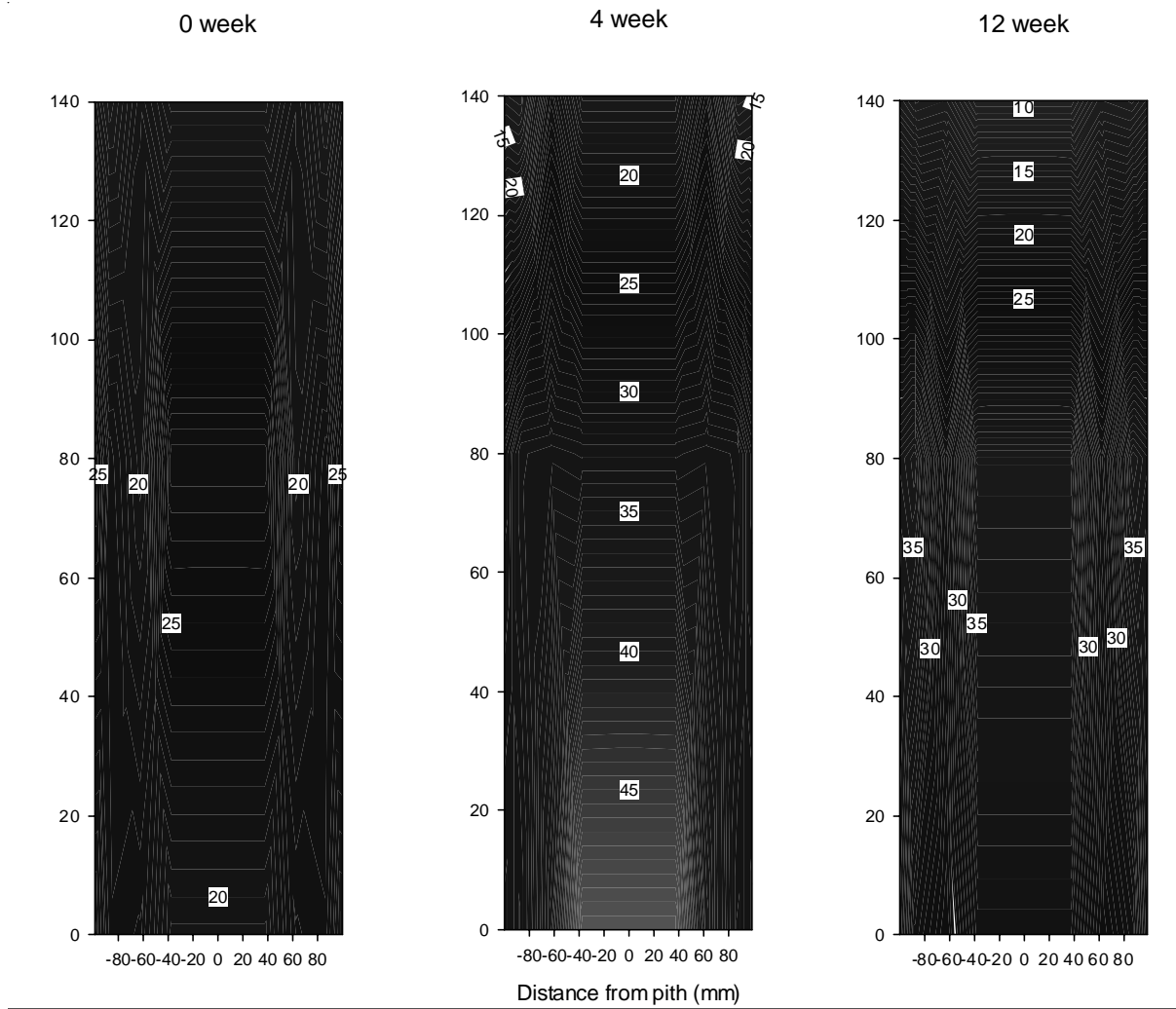

Figure III-31. Moisture contents of copper naphthenate treated western redcedar poles wrapped with a Biotrans liner from the butt to the groundline and immersed in water for 0 to 12 weeks.

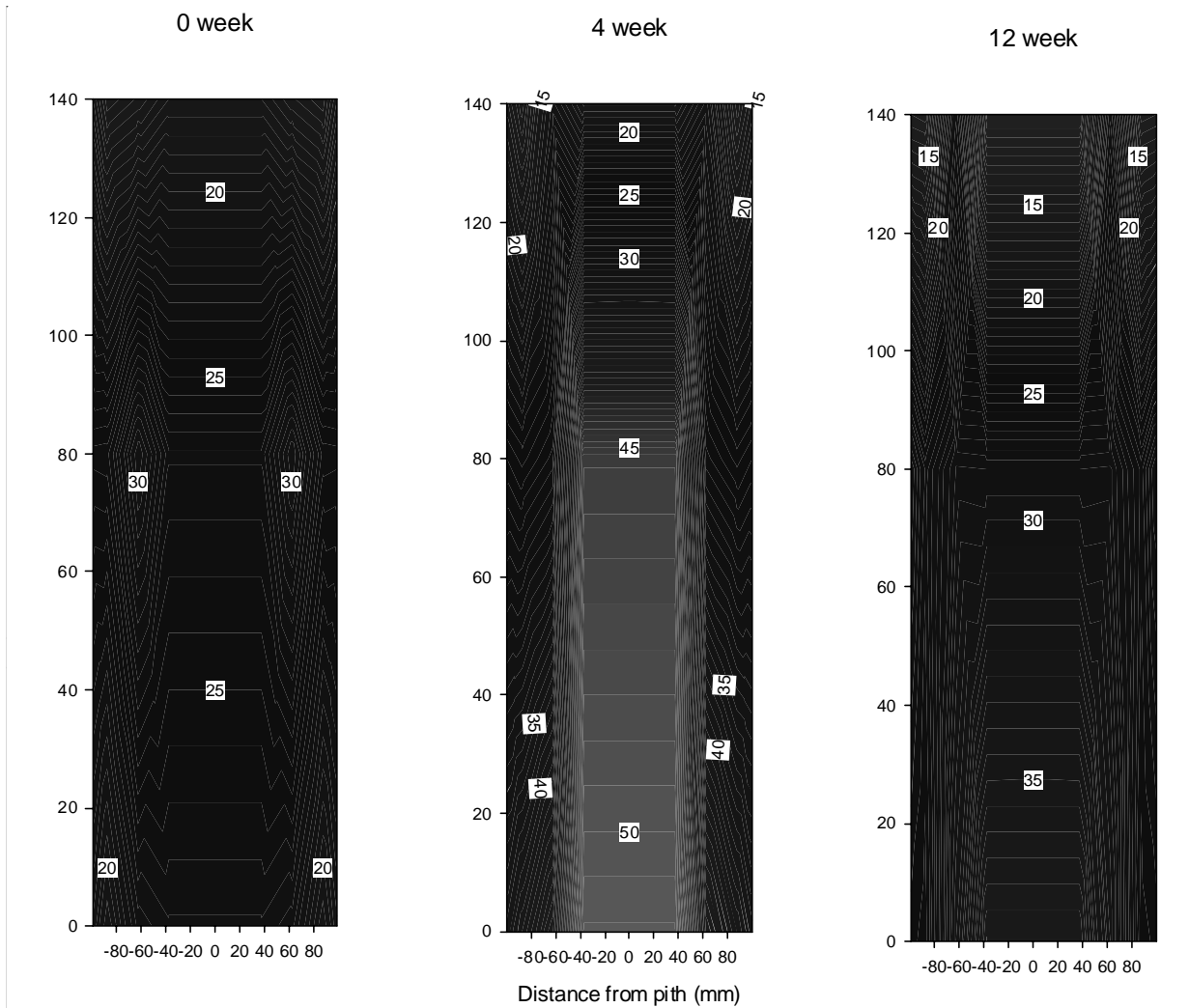

Figure III-32. Moisture contents of copper naphthenate treated western redcedar poles wrapped with a Biotrans liner from the butt to the groundline and immersed in moist soil for 0 to 12 weeks.

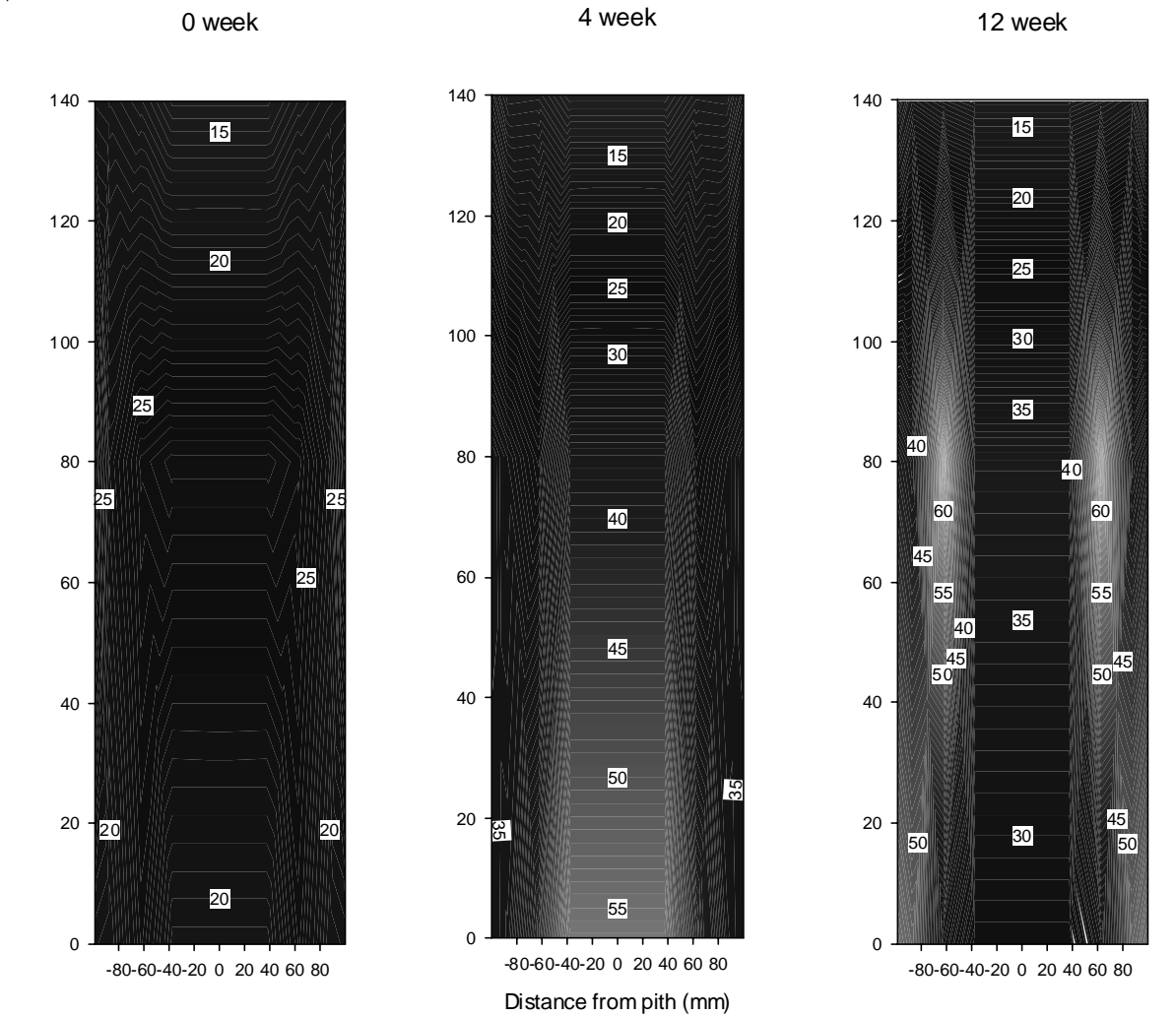

Figure III-33. Moisture contents of pentachlorophenol treated western redcedar poles wrapped with a Biotrans liner from the butt to the groundline and immersed in water for 0 to 12 weeks.

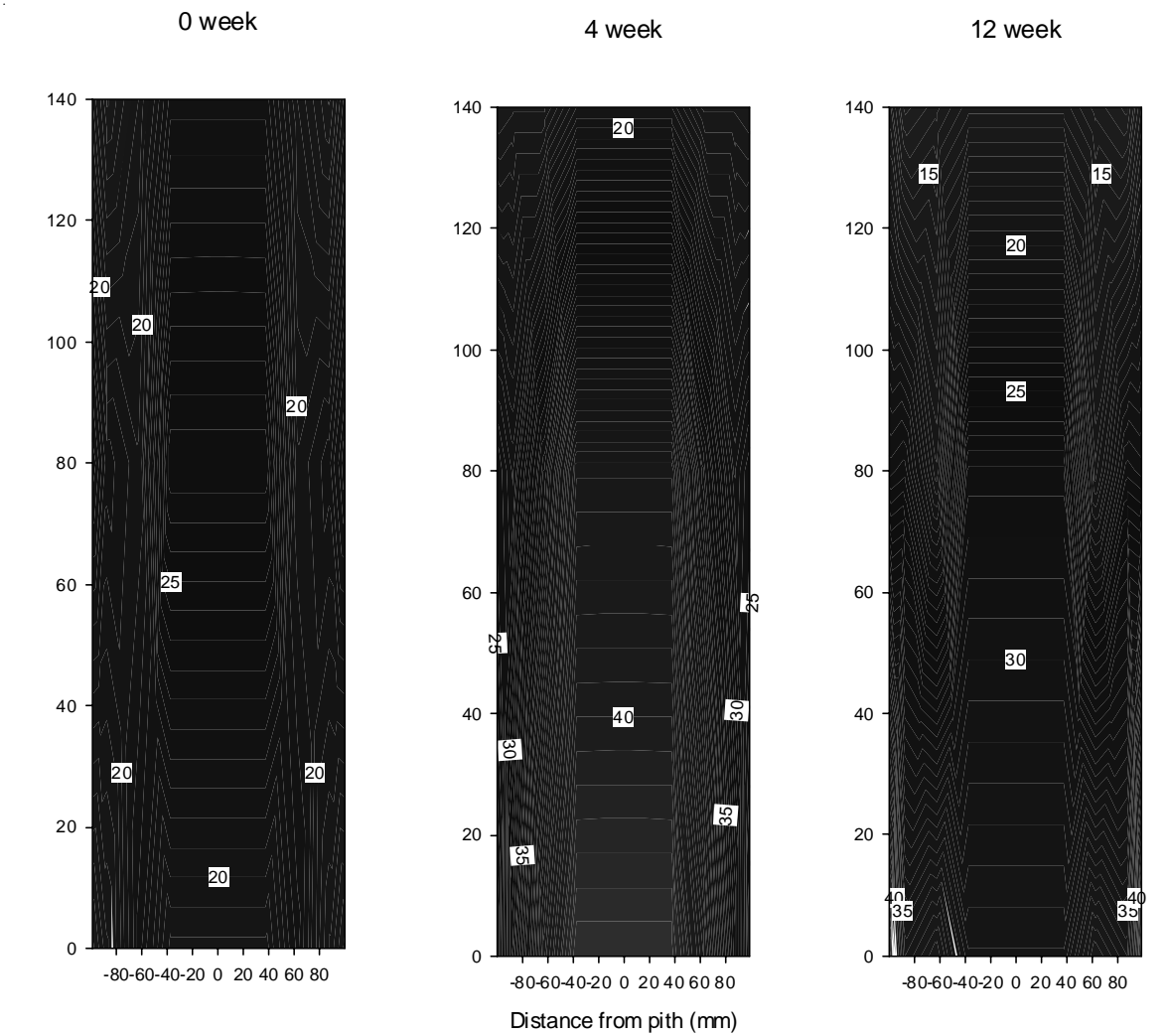

Figure III-34. Moisture contents of pentachlorophenol treated western redcedar poles wrapped with a Biotrans liner from the butt to the groundline and immersed in moist soil for 0 to 12 weeks.



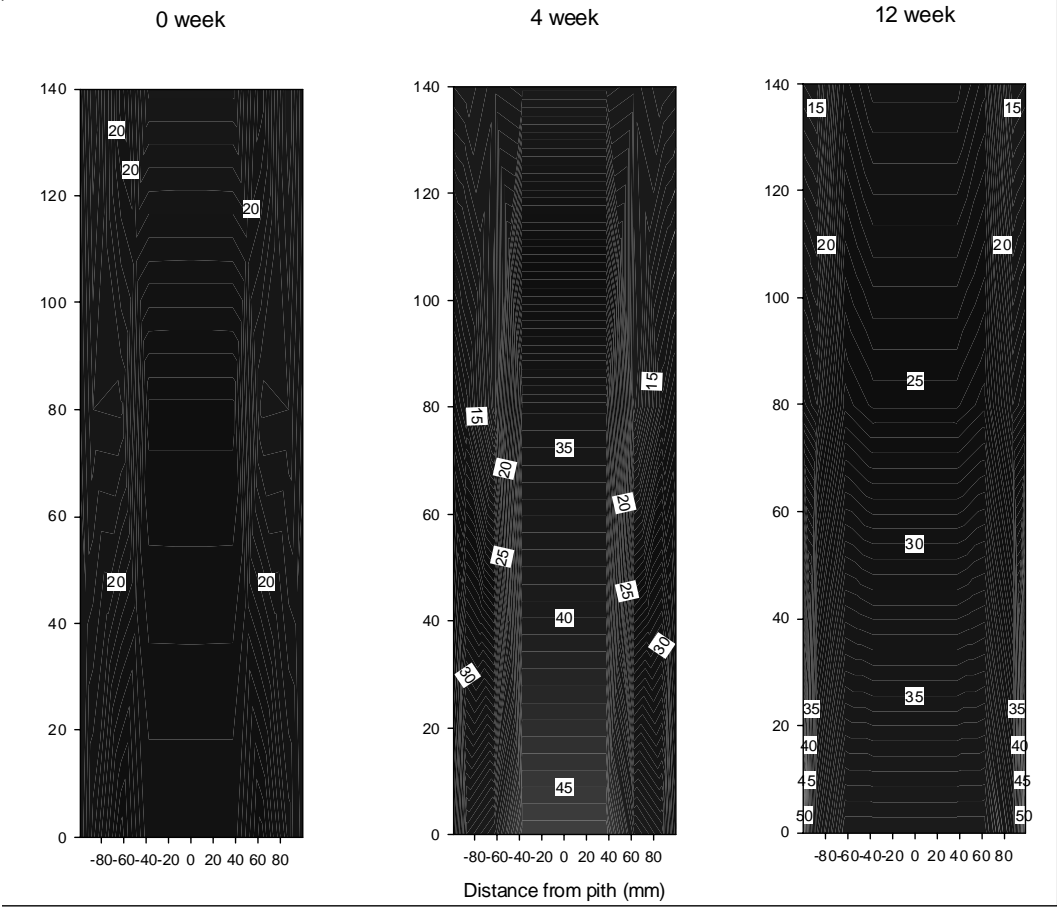

Figure III-35. Moisture contents of copper naphthenate treated western redcedar poles wrapped with a UPC liner from the butt to the groundline and immersed in water for 0 to 12 weeks.

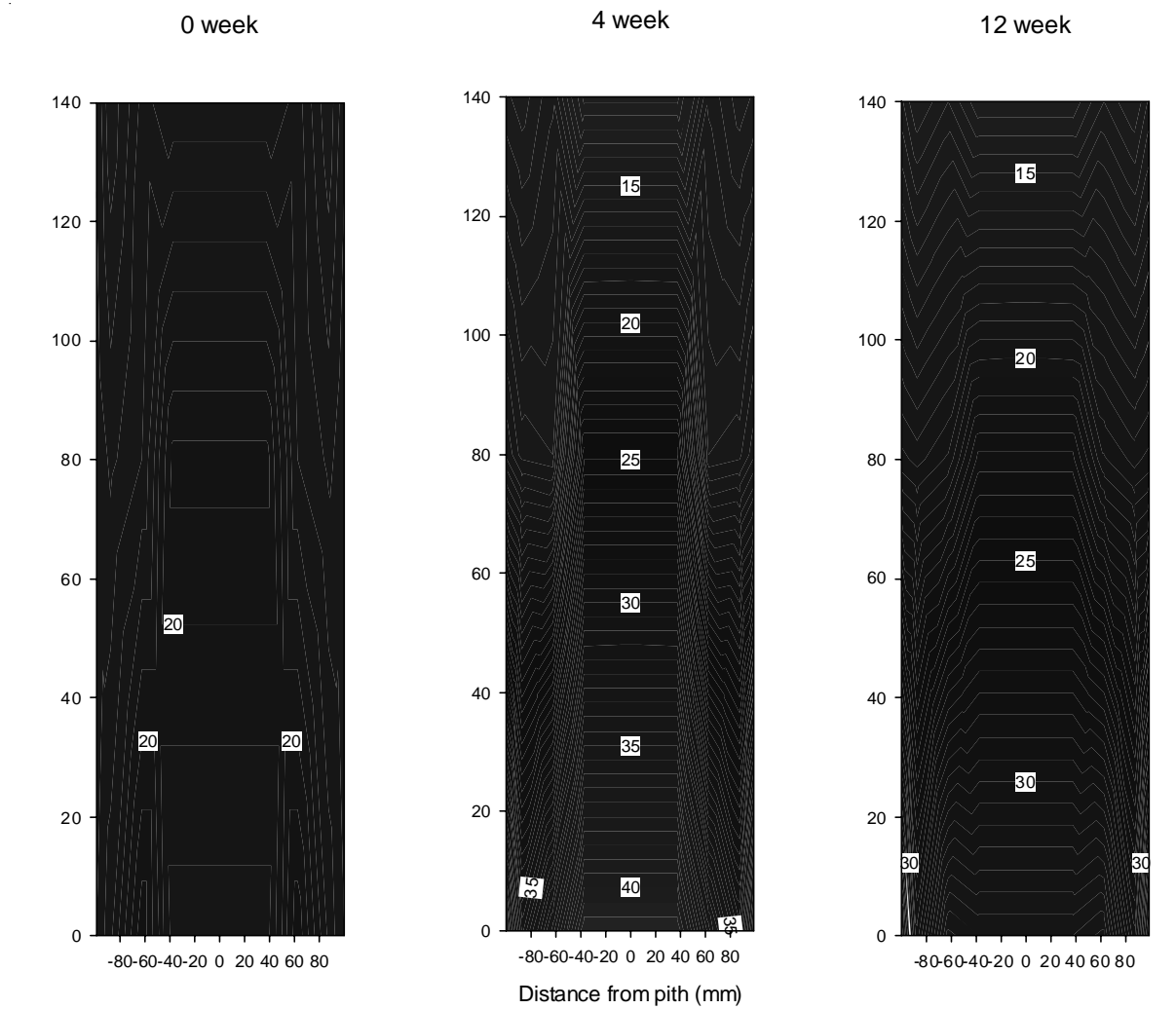

Figure III-36. Moisture contents of copper naphthenate treated western redcedar poles wrapped with a UPC liner from the butt to the groundline and immersed in moist soil for 0 to 12 weeks.

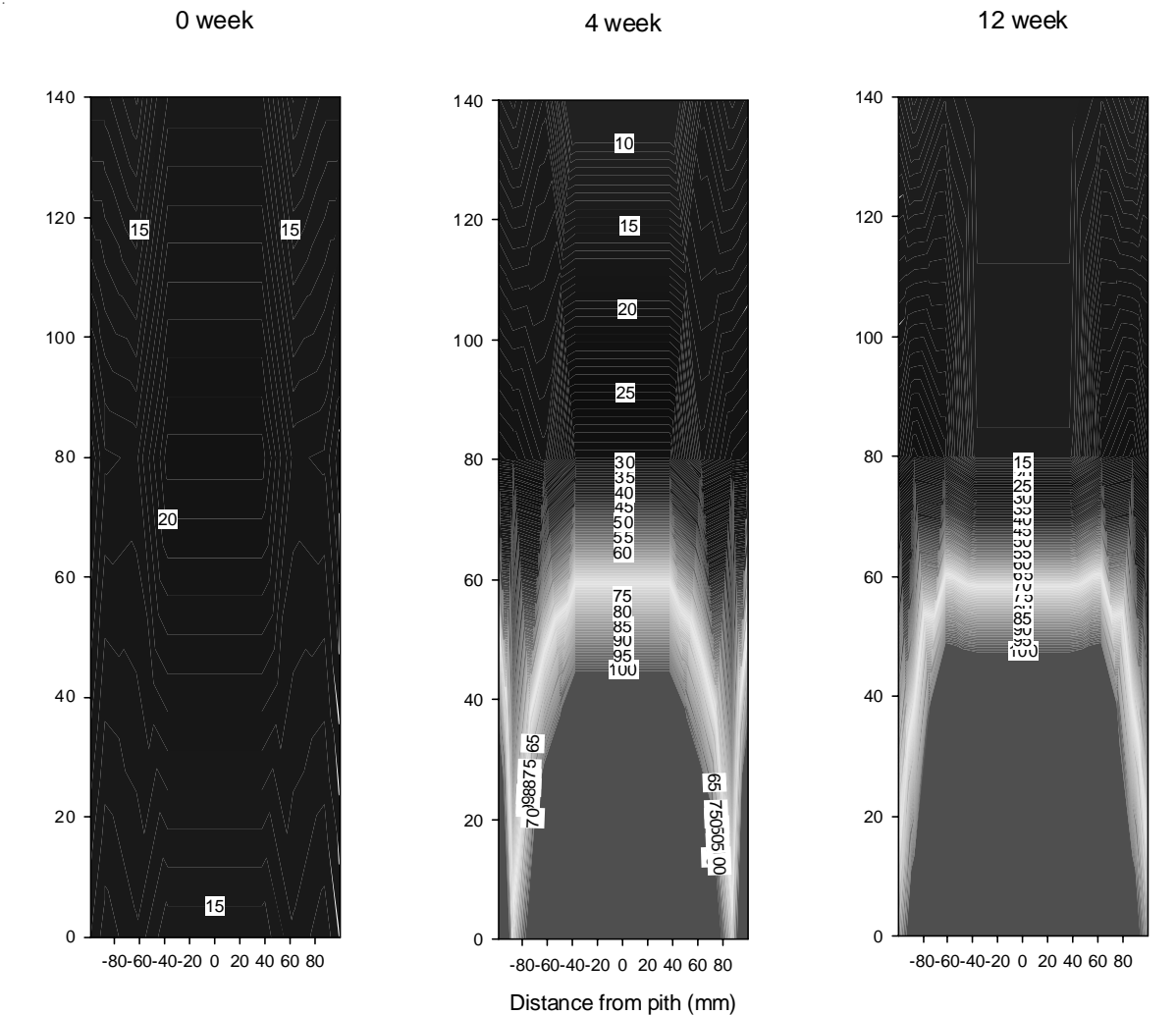

Figure III-37. Moisture contents of untreated western redcedar poles wrapped with a UPC liner from the butt to the groundline and immersed in moist soil for 0 to 12 weeks.

Exposure to either soil or water for an additional 8 weeks (12 weeks total) produced little or no change in moisture contents at most locations. Moisture levels did not appear to appreciably increase 80 or 140 cm above the butt. These results suggest that moisture movement upward from the open ends of the poles is limited. The relatively slow upward movement may reflect the refractory nature of western redcedar heartwood, which is normally resistant to fluid flow.

The results, while preliminary, indicate that the barriers have limited moisture ingress at the groundline. Further sampling will be necessary to assess upward moisture migration from the open ends of these systems.

## E. Effect of Pole Seasoning Methods on Residual Strength of Utility Poles

The moisture contents of freshly cut coniferous trees used for utility poles usually range from 80 to 120 % in the outer living sapwood and 40 to 60 % in the heartwood. This moisture can have important impacts on the quality of the resulting pole. First, the wood will remain susceptible to biological attack as long as the moisture content remains above 30 %. Excessive moisture can also result in uneven preservative distribution, which can result in bleeding and create zones where decay can later develop. Poles treated at higher moisture contents also have a tendency to continue to season and check in service and these checks often open beyond the depth of the original preservative treatment. Untreated wood exposed in these checks can then serve as points of entry for fungi and insects. Thus, an important part of the pole production process involves removing moisture from the wood without adversely affecting other pole properties. In an ideal world, poles would be thoroughly seasoned to their in-service moisture contents prior to treatment, however, this is largely impractical because of the large dimensions and difficulty in drying the pole interior. Instead, seasoning primarily focuses on the outer sapwood zone that will ultimately be treated with preservative, while the interior heartwood still remains well above the fiber saturation point.

There are a variety of methods for removing moisture prior to treatment and each can impact the quality of the resulting product. Many utility engineers have expressed concerns about the impacts of various practices on pole strength, but there are few comprehensive reviews of these potential impacts. The American National Standards Institute Standard 05.1 incorporates these effects in the fiber stress values for various pole species, but there is still a lingering concern about the effects of heat on wood poles. In this section, we will review the methods for seasoning of poles and discuss the potential impacts of each on pole quality. This is an initial draft of this section, which will eventually be placed on the Coop website for future reference.

Poles can be seasoned in a variety of ways, but the most commonly used methods are air-seasoning, kiln drying, steam conditioning, and Boulton seasoning. In some instances, combinations of these methods are used such as the use of initial air-seasoning followed by Boulton-seasoning.

**Air Seasoning:** Air seasoning has long been used for moisture removal from wood because of its low cost and simplicity. Poles are peeled as soon as possible after felling, then stacked to allow for maximum air-flow. Air seasoning can produce acceptable moisture contents in the outer sapwood zone in as little as three months under the proper conditions; however, the process is not without risk. The freshly felled pole is susceptible to attack by a variety of wood boring insects and wasps. These insects tend to lay their eggs on or in the bark. The eggs hatch and the resulting larvae tunnel into the wood. In most cases, prompt bark removal sharply reduces this risk, but it also exposes the moist sapwood to possible fungal attack. A number of studies have shown that freshly exposed poles are rapidly colonized by a wide array of fungi, including many possible decay fungi. The risk increases with the amount of sapwood present in the wood and with the climatic conditions. Thicker sapwood species such as southern pine tend to be more susceptible to degradation than thinner sapwood species such as Douglas-fir or western redcedar. Environmental conditions also play a role in the rate of both colonization and decay. Fungal attack will tend to occur more rapidly under warmer wetter conditions. Although it was not developed for this purpose, the Scheffer climate index, which uses the average monthly number of days with rainfall and the mean monthly temperature to produce a decay risk number that ranges from 0 to 130 for the continental U.S. can be used to assess the risk of decay in stored poles. The Pacific Northwest has climate indices ranging from 30 to 60, while central Florida has an index approaching

130. When this index is used in combination with wood species, it becomes obvious that seasoning a southern pine pole in Florida poses a considerably greater challenge than seasoning a Douglas-fir pole in Oregon.

There are relatively few previous studies of the effects of air-seasoning pole quality. Taylor produced a series of papers on seasoning of poles and concluded that the practice should be banned. Graham (1983) countered in a review paper that air seasoning could be practiced, but sterilization following seasoning was a key factor in performance. Several papers have noted extensive decay in southern pine poles that were improperly air-seasoned (Toole, 1963; Lindgren, 1963). In fact, Lindgren, in what was one of the first applications of biocontrol, attempted to limit fungal attack by applying fluoride to stimulate growth of *Trichoderma* spp. on poles. This fungus can inhibit the growth of many decay fungi. The thick sapwood present on southern pine and the warm, humid conditions under which most of the poles of this species are likely to be handled, sharply limit the potential for air-seasoning of this species without inducing severe strength losses.

Conversely, extensive studies of air-seasoning of Douglas-fir poles showed that most poles had at least one decay fungus within 6 months of air-seasoning and all were colonized within one year. Fungal colonization steadily increased over time and most of the important decayers of this species were present. Tests of beams cut from these fungal colonized pole sections, however, showed no significant changes in material properties for the first two years of air seasoning and only a suggestive loss in the third year of seasoning. These seemingly contradictory results illustrate the differences between fungal colonization and serious effects on the wood polymers. While fungi can rapidly colonize the wood, they initially utilize the readily available sugars stored in the ray cells and do not appear to cause substantial effects on wood properties until these stored sugars are consumed. The moderately durable heartwood of Douglas-fir and the more benign climate conditions in the Pacific Northwest appear to further slow this process. As a result air-seasoning of this species does not pose a hazard to pole quality, provided the fungi colonizing the poles are later eliminated at some point in the treatment process. Limited studies of western redcedar indicate that fungal colonization during air-seasoning is minimal owing to the natural durability of the heartwood and the relative thinness of the sapwood, which dries below the fiber saturation point relatively quickly. These characteristics limiting the potential for fungal attack. In addition, field trials have shown that the few fungi that do colonize poles of this species are killed during the thermal treatment process

When poles are air-seasoned, there are several important practices that can reduce the risk of fungal attack. These include:

1. Placing poles on stickers out of soil contact in well-ventilated stacks
2. Removing all vegetation beneath and around the poles
3. Providing adequate drainage to avoid standing water
4. Removing older, decay wood that might serve as an inoculum source
5. Rotating pole stock so that poles are not seasoned for too long
6. Ensuring that the poles are sterilized at some point after seasoning

These practices can allow poles to be safely air-seasoned within the constraint posed by wood species and environmental conditions.

**Steam conditioning:** Steam conditioning is a process whereby freshly cut and peeled poles are subjected to high pressure steam (115 C) for periods ranging from 17-20 hours, then the poles are allowed to cool. The steaming process raises the temperature of any moisture in the wood above the

boiling point and results in substantial drying prior to treatment. Steam conditioning is allowed for southern pine and ponderosa pine poles, but is not allowed for Douglas-fir poles because the latter species experiences considerable strength loss when heated at high temperature in the wet or green condition.

Stream conditioning was once widely used because it allowed rapid processing of freshly cut pine poles and also allowed poles to be treated when the moisture content remained somewhat higher (25-40 %). The process also ensures that poles are sterilized prior to treatment. The negative attributes of the process were that inadequate steaming could result in pockets of higher moisture content wood that would then be difficult to treat. These wet pockets would have lower preservative retentions that would be more susceptible to internal decay. There were a number of incidences of very early failures of steam conditioned penta treated southern pine poles in Canada and the mid-West. Steam conditioning was also energy intensive and created considerable quantities of preservative contaminated waste water (since the process was generally done in the same cylinders used for treating). Finally, steam conditioning was one of the processes used to condition southern pine poles prior to treatment with copper naphthenate. Subsequent work showed that excessive water in the treating solutions as a result of steaming led to serious emulsion problems that produced inadequately treated poles. The result of these treatment problems was a rash of early failures of copper naphthenate treated southern pine. The switch from steam conditioning to kiln drying largely eliminated this problem.

Steam conditioning is less frequently used for pole seasoning because of the advent of large pole kilns in much of the southern U.S.

**Kiln drying:** Kiln drying has long been used to remove moisture from wood prior to use. For many years, kiln drying of poles was rare because of the relatively large volumes of wood and the availability of other seasoning methods. Changes in wastewater handling, energy costs, and the emergence of CCA treatments for poles all combined to encourage the construction of pole kilns in many treating plants. As with steam conditioning, kiln drying is far more prevalent for pine poles in the southern U.S. than it is for either western redcedar or Douglas-fir. In part, this reflects the ability of western treaters to partially or completely air-season poles with less risk of damage.

Kiln-drying involves placing poles in a chamber and then using combinations of heat and relative humidity to drive moisture from the wood. Typically, the kiln processes use elevated heat and then lower the humidity to varying degrees over time to enhance drying. Generally, the humidity is maintained at a relatively high level early in the process to enhance heating and slow the rate of drying, then the humidity is lowered and the temperature is raised over the remainder of the process. Kiln drying of poles can be divided into two very different processes. Southern pine poles are usually dried using relatively aggressive schedules that employ high temperatures (88-110 C) owing to the ability of these species to withstand higher temperatures in the green condition without experiencing structural damage. A typical southern pine pole drying schedule might last 3 or 4 days. Schedules used for Douglas-fir poles tend to be milder with maximum temperatures between 60-82 C and relatively narrow differences in relative humidity are used. The slow rate of drying is important because of the potential for the pits connecting individual cells in this species to close or aspirate if the drying rate is too rapid. In addition, Douglas-fir is much more sensitive to elevated temperatures when wet. A typical schedule for drying Douglas-fir poles might last 4 to 6 days.

The advantages of kiln drying include a controlled drying rate, the ability to process poles from green to dry condition in a relatively short time, and the ability to sterilize the pole. The latter aspect is particularly



important for southern pine poles that are subsequently treated with waterborne chemicals such as chromated copper arsenate. These treatments do not generally involve the use of heating and the sterilization from kiln drying ensures that no fungi are present in the pole center after treatment. Kiln drying sterilization is also important when poles are treated with oilborne solutions for shorter periods that may not allow for adequate heating of the pole center.

The primary negative aspects of kiln drying are the cost of installing kilns and the energy costs involved in processing. Secondary issues include stringent volatile organic compound emission regulations. In addition, kiln drying does not prevent reinfestation of poles by decay fungi, so the dry poles need to be treated relatively soon after drying to limit this potential. Excessively high kiln temperatures can have obvious effects on wood strength, but these effects are relatively well documented and there are limitations in the American Wood Preservers' Association Standards to minimize the potential for such effects.

**Boulton-seasoning** was developed in the 1880's to season poles in the treating cylinder. In this process, heated oil (usually containing the preservative) is added into the treating cylinder along with green poles. The oil is heated and a vacuum is drawn over the treating solution. The vacuum lowers the boiling point of water in the wood, producing more rapid drying. The water removed by the vacuum is collected and condensed so that the rate of moisture removal can be assessed. Moisture is removed relatively rapidly early in the process, then the rate slows as moisture levels fall below the fiber saturation point. Boulton seasoning has long been used to dry Douglas-fir poles and is considered to be a relatively mild seasoning process because the water leaves the wood in vapor form. Limited testing confirmed the minimal effects of Boulton seasoning on strength. Boulton seasoning typically lasts from 20 to 50 hours and results in moisture contents between 15 and 20 % in the outer sapwood. The process also sterilizes the wood and helps to open seasoning checks, thereby reducing (but not eliminating) the risk that untreated wood will later be exposed in checks.

The primary negative aspects of Boulton seasoning are the higher energy costs (compared with air-seasoning) and the enormous quantities of oil contaminated water that are generated via this process. These aspects can be managed and do not affect the quality of the finished pole, but can add to production costs. Many treaters use partial air-seasoning, followed by a shorter Boulton cycle to reduce energy costs, but still sterilize and condition the wood prior to treatment. In addition, it is possible to over-dry poles by Boulton-seasoning, resulting in case-hardening. Careful monitoring of condensation rates from the vacuum line can limit the potential for case hardening.

In addition to the traditional moisture removal processes, there are other heating steps in the treatment process that might affect pole quality. These include initial steaming, pre-heating, expansion baths and final steaming.

**Initial Steaming:** In addition to steam conditioning, some steaming is allowed prior to treatment to either remove ice from poles, or in the case of treatments of kiln dried or air-seasoned poles with ammoniacal copper zinc arsenate, ammoniacal copper arsenate or ammoniacal copper quat as a preconditioning process. Steaming is limited by the AWWPA specifications to between 4 and 8 hours, depending on the wood species. The primary goal of steaming is to soften the wood and help to open the pits. In most cases, the treatment is followed by the use of heated treating solutions that further improve the ability of the fluid to move into the wood.

Limited testing has shown that pre-treatment steaming has no negative strength effects on the wood within the stated parameters.

**Heating in Preservative:** Heating in preservative is typically used with oil-borne solutions to condition the wood prior to application of pressure. The warmer conditions reduce solution viscosity and may also allow pits to open, permitting deeper, more uniform treatment. Initial heating is not a seasoning process, per se, but the heat can more evenly distribute moisture in the wood and also helps in sterilization. The AWWPA Standards limit the temperatures for this process, but not the total time.

**Expansion Baths:** Expansion baths are typically used at the end of the treated cycle. The temperature of the treatment solution is raised 15 to 20° F and then held for varying period of times. The primary purposes of the expansion bath are to recover excess preservative solution and reduce the potential for preservative bleeding. A number of studies have shown that there is considerable internal pressure in a pole at the conclusion of the treatment process and failure to relieve this pressure can lead to bleeding and unsightly preservative deposits. The inclusion of expansion baths within the limits of the AWWPA Standards does not appear to affect pole strength, although prolonged exposed to elevated temperature can induce losses in bending properties.

**Final Steaming:** Final steaming is used on many pole species to encourage preservative solution recovery, reduce internal pressure and clean the pole surface. It may also be used to increase the rate of preservative deposition or fixation for water based solutions such as CCA, ACQ or ACZA.

**Summary:** Pole seasoning can be performed using a variety of methods that, when used properly, have little negative effect on material properties of the pole. Careful inspection of treatment facilities to ensure that poles are not stored for long periods, that treatment conditions are adequate for sterilization, and that moisture is uniformly removed at some point in the treatment process, can all help to ensure that poles installed in the utility system provide the highest possible reliability.



---

---

## Literature Cited

- American National Standards Institute. 1992. American National Standard for Wood Poles – Specifications and Dimensions. ANSI, New York. 26 pp.
- Brown, D. L. and Davidson, D.F. 1961. Field tests of relative strength of incised fir poles. Portland General Electric Co., Portland, OR.
- Engineering Science Data Unit (ESDU), 1989. Elastic stress concentration factors. Geometric discontinuities in rods and tubes of isotropic materials. #89048. 26 pp.
- Falk, R. H., DeVisser, D., Plume, G.R. and Fridley, K.J., 2003. Effect of drilled holes on the bending strength of large diameter Douglas-fir lumber. *Forest Products Journal*. 53(5): 55-60.
- Jessop, H. T., Snell, C. and Allison, I.M., 1959. “The stress concentration factors in cylindrical tubes with transverse circular holes.” *Aeronautical Quarterly*. 10: 326-344.
- Kent, S. 2003. “Structural calculations to estimate the effect of ground line holes in wood poles.” Report to USDA Forest Service. Unpublished. 22 pp.
- Pellicane, P. and Franco, N. 1994. “Finite element analysis of wood poles”. Proc., Pacific Timber Engineering Conference. 1: 445-457.
- Pilkey, W. D. 1997. *Peterson’s Stress Concentration Factors*. John Wiley & Sons, Inc. New York, NY. 508 pp.
- Thum, A. and Kirmser W. 1943. “Überlagerte Wechselbeanspruchungen, ihre Erzeugung und ihr Einfluss auf die Dauerbarkeit und Spannungsausbildung quergebohrter Wellen.” VDI-Forschungsheft 419, 14(b): 1.
- Ting, K., Chen K. T. and Yang, W.S. 1998. “Applied alternating method to analyze the stress concentration around interacting multiple circular holes in an infinite domain.” *International Journal of Solids and Structures*. 36: 533-536.
- United States Department of Agriculture (USDA). 1999. *Wood Handbook: Wood as an Engineering Material*. USDA Forest Service, Forest Products Laboratory. Madison, WI.
- Utility Pole Research Cooperative Report. 1998. College of Forestry. Oregon State University. Corvallis, OR. pp. 45-47.
- Wu, H. and Mu, B. 2003. “On stress concentrations for isotropic/orthotropic plates and cylinders with a circular hole.” *Composites. Part B, Engineering*. 34(2): 127-134

## *Objective IV*

### **PERFORMANCE OF EXTERNAL GROUNDLINE PRESERVATIVE SYSTEMS**

---

While preservative treatment provides excellent long term protection against fungal attack in a variety of environments, there are a number of service applications where the treatment eventually loses its effectiveness. Soft rot fungi can then decay the wood surface, gradually reducing the effective circumference of the pole until replacement is necessary. In these instances, pole service life can be markedly extended by periodic below ground application of external preservative pastes that eliminate fungi in the wood near the surface and provide a protective barrier against reinvasion by fungi in the surrounding soil.

For many years, the pastes used for this purpose incorporated a diverse mixture of chemicals including pentachlorophenol, potassium dichromate, creosote, fluoride and an array of insecticides. The re-examination of pesticide registrations by the U.S. Environmental Protection Agency in the 1980's resulted in several of these components being listed as restricted use pesticides. This action, in turn, encouraged utilities and chemical suppliers to examine alternative preservatives for this application. While these chemicals had prior applications as wood preservatives, there was little data on their efficacy as preservative pastes and this lack of data led to the establishment of this objective. The primary goals of this objective are to assess the laboratory and field performance of external preservative systems for protecting the below ground portions of wood poles.

#### **A. Performance of External Preservative Systems on Douglas-fir, Western redcedar, and Ponderosa Pine Poles in California**

The field test in California is now completed. The final results were provided in the 2002 annual report.

#### **B. Performance of Selected Supplemental Groundline Preservatives in Douglas-fir- Poles Exposed Near Corvallis Oregon**

The pole sections in the field test of copper/boron and copper/boron/fluorides have declined to the point where they can no longer be sampled and this test was terminated in 2003.

#### **C. Performance of External Treatments for Limiting Groundline Decay in Southern Pine Poles Near Beacon, New York**

Eighty southern pine transmission poles in the Central Hudson Electric and Gas system were selected for study. The poles were randomly allocated to groups of 10 and received one of the following treatments:

- Osmose Cop-R-Plastic (now Osmoplastic)
- Osmose Pole Wrap RTU
- BASF Wrap with Cu/F/B
- BASF Wrap with Cu/B
- Genics Cobra Wrap
- Genics Cobra Slim
- Triangle Laboratories Biological Treatment

The treatments were applied 0 to 450 mm below the groundline, and then the soil was backfilled. The total amount of chemical applied to each pole was determined by weighing containers before and after chemical application or by measuring the total amount of prepared wrap applied. An additional set of ten poles served as non-treated controls.

Since the time of the test installation, the Cobra Slim, which was an experimental product, has been removed from the market. The chemical has been kept in the test because it can provide useful information about the effects of the bandage material on performance; however, the material used for the backing differs with that used in the commercial system.

The poles were sampled 2 and 3 years after treatment by removing increment cores from selected locations 150 mm below groundline. The cores were cut into two different patterns, depending on the remedial treatment chemical involved. For copper based systems, the cores from a given treatment were cut into zones corresponding to 0-6 mm, 6-13 mm, and 13-25 mm. These assays zones were kept nearer the surface in recognition of the limited ability of copper to move into the wood. The samples from poles treated with systems containing either boron or fluoride were divided into zones corresponding to 0-13 mm, 13-25 mm, 25-50 mm and 50-75 mm from the surface, in recognition that these chemicals are capable of moving rather deeply into the wood with moisture. Two sets of cores were removed from poles treated with systems containing both copper and a water diffusible component. In addition, wood from each pole was cultured for the presence of fungi by placing small chips cut from each pole on the malt extract agar and observing for evidence of fungal growth. Any fungi were examined under a microscope and identified using the appropriate keys. The poles were sampled in August and culturing and identification is currently underway.

Copper levels tended to follow a decreasing gradient from the surface inward, reflecting the relative inability of copper to move for long distances into the wood (Figure IV-1). Copper levels in poles treated with copper containing systems

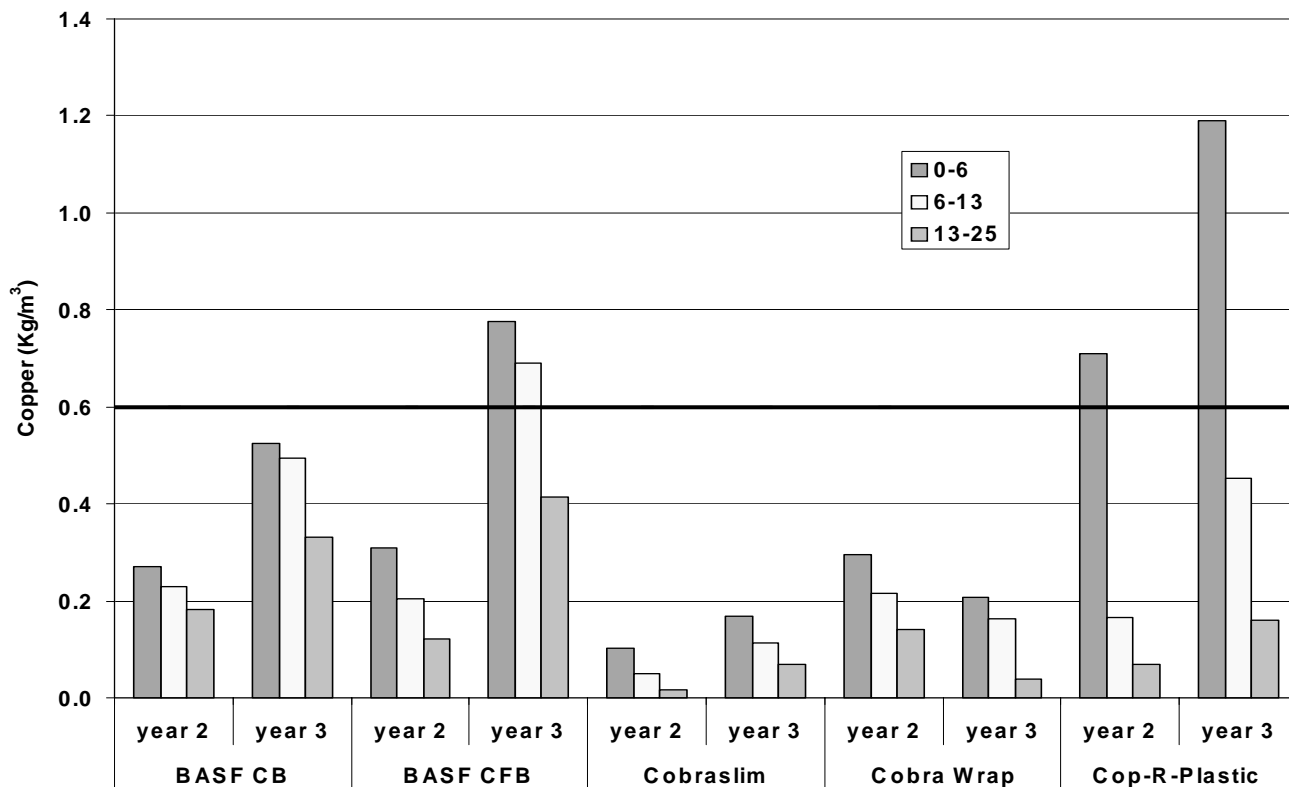

Figure IV-1. Residual copper levels at selected distances from the wood surface 150 mm below groundline on southern pine poles 2 and 3 years after treatment with selected external supplemental preservative bandage systems. Values represent the average of six borings from five poles.

were generally below the threshold for protection against fungal attack, except for the 3 year data for the 0-6 and 6-10 mm zones for the BASF copper/fluoride/boron bandage and the 2 and 3 year data for the 0-6 mm assay zone for the Cop-R-Plastic. Copper levels were generally low with both the Cobra and Cobra Slim and were approximately 85 % of the threshold in the outer zone for the BASF copper/boron system. It is important to remember that the copper threshold is the level required for protection when only copper is present and it is likely that the level will be much lower in the presence of other preservatives. The results, however, do show that copper movement was better in the Cu/F/B and Cu/F systems.

Boron was present only in the two BASF systems. Boron levels were just below the lower threshold 2 years after treatment with the Cu/B wrap and declined slightly after an additional year of exposure (Figure IV-2). There was little evidence of a boron gradient from the surface inward, suggesting that boron was moving relatively uniformly through the wood. Boron levels in the Cu/F/B wrap were much lower than those found with the copper/boron system, perhaps reflecting a reduced initial boron loading or some interference between the two chemicals.

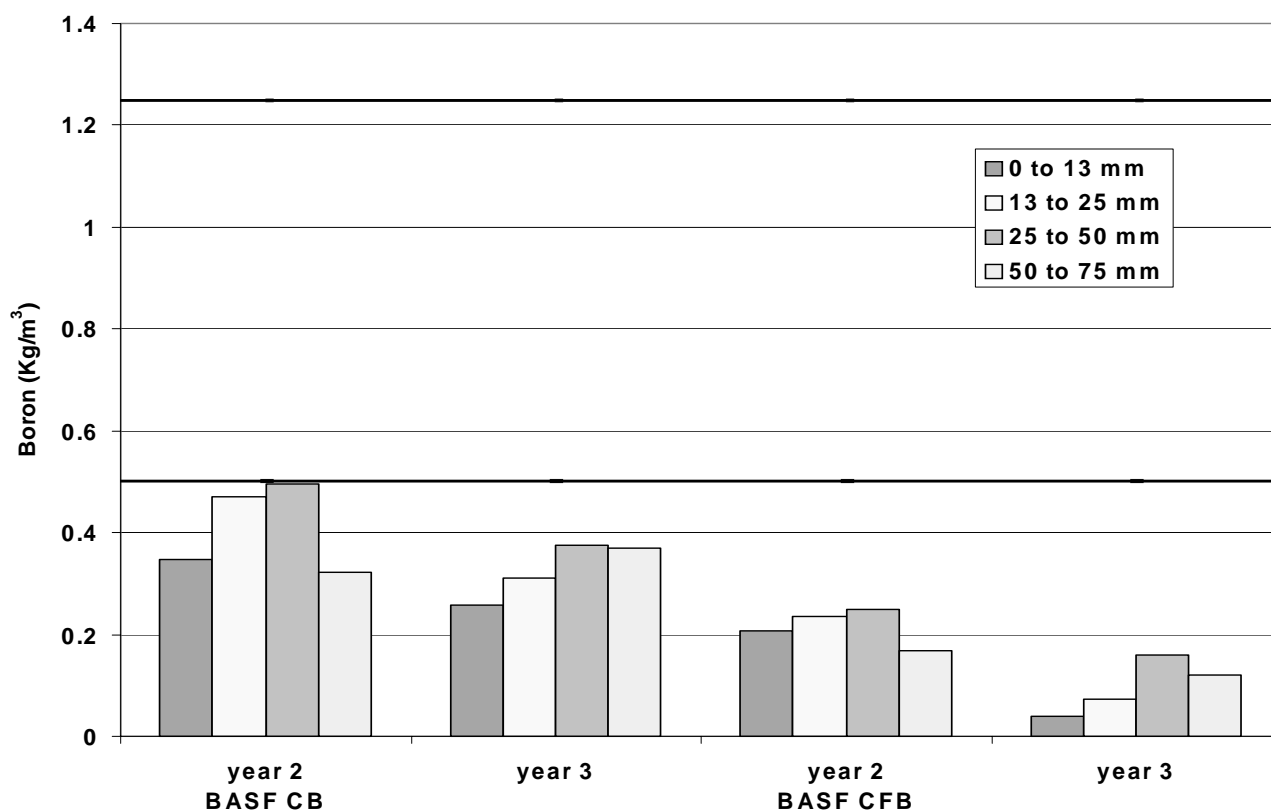

Figure IV-2. Residual boron levels at selected distances from the wood surface 150 mm below groundline on southern pine poles 2 and 3 years after treatment with selected external supplemental preservative bandage systems. Values represent the average of six borings from five poles.

Fluoride was present in one BASF system as well as the Cop-R-Plastic and Pole Wrap systems. Fluoride levels tended to follow a gradient from the surface inward for all three systems, although the gradients with the BASF system were relatively shallow (Figure IV-3). Fluoride levels were below the lower threshold for fungal protection after 2 and 3 years for the BASF system, while levels were at or above the upper threshold 0-25 mm from the surface in both the Cop-R-Plastic and Pole Wrap systems. Fluoride levels in all four assay zones were all above the lower threshold 3 years after treatment with both the Cop-R-Plastic and Pole Wrap systems.

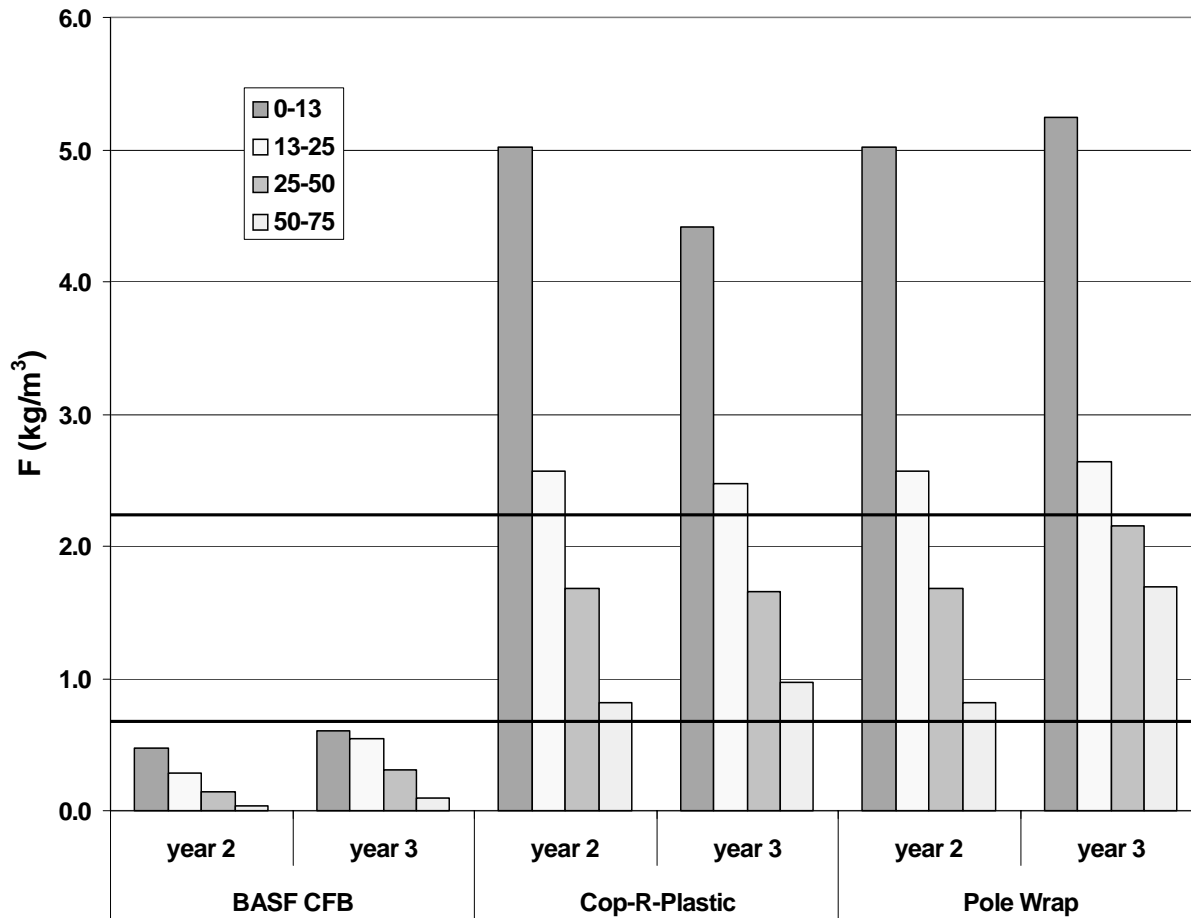

Figure IV-3. Residual fluoride levels at selected distances from the wood surface 150 mm below groundline on southern pine poles 2 and 3 years after treatment with selected external supplemental preservative bandage systems. Values represent the average of six borings from five poles.

As in previous years, it remains difficult to determine the amounts of individual chemicals needed to perform in the multi-component systems. There is clearly the potential for synergy among the various components, but examining these interactions has been difficult. In addition, the original preservative, while at a somewhat reduced retention, still contributes to the performance. As a result, these analyses must be viewed as relative. Systems which deliver greater amounts of active ingredients that remain for longer periods in the wood are more likely to provide better long term protection against renewed fungal attack.

#### D. Performance of a Fluoride/Boron Bandage on Douglas-fir Pole Stubs

Ten air-seasoned Douglas-fir pole sections (250-300 mm in diameter by 2 m long) were treated with a fluoride/boron bandage system from the butt to approximately 0.6 m above that zone. The pole sections were then set to a depth of 0.6 m at the Peavy Arboretum test site. The wrap consisted of a dimpled plastic sheet and each dimple contained a pellet of a fluoride/boron rod (Preschem, Ltd.). Chemical movement from the sheets was assessed 4, 6, 8, and 10 years after treatment by removing increment cores from three equidistant locations around each pole 150 mm below the groundline. The outer 25 mm from each core was assayed at the four year sampling point. In later analyses, the cores were divided into zones corresponding to 0-5, 5-10, 10-15, and 15-25 mm from the surface. These zones from a given pole were ground to pass a 20 mesh screen, then assayed for boron by the azomethine H method and for fluoride by hot water extraction and analysis of the extract using a specific ion electrode.

The poles in this test have remained extremely sound over the 10 year test, a result quite different from many of our other tests, where untreated pole sections rapidly degrade and are unusable within 5 years of installation. Fluoride levels in the poles were low 4 years after treatment (0.062 kg/m<sup>3</sup> for the combined sample), then rose sharply over the next two years (Figure IV-4) though they never reached the lower threshold level for fluoride at any point during the test. Levels have steadily declined since that time and there is little or no fluoride in the poles 10 years after treatment.

Boron levels were above the protective threshold 6 years after treatment. Boron has been present at levels above the lower threshold in all four assay zones for each of the next three sampling dates. While the levels have gradually declined between 6 and 10 years, the boron levels remain sufficient to protect the wood. The elevated boron levels are surprising in light of the performance of other boron containing systems as external preservatives. Boron has high water solubility and, while it can move rapidly into the wood, it also tends to be depleted into the surrounding soil over time. This did not occur in these fluoride/boron tests. This slower loss may be due to the external plastic bandage, which minimizes soil contact with the pole and reduces the risk of leaching. These attributes may help account for the condition of these posts so long after installation.

While the fluoride/boron system is not currently registered in the US, there is an effort to do so in the near future. Should this occur, our data suggests that this system should provide excellent protection against surface decay

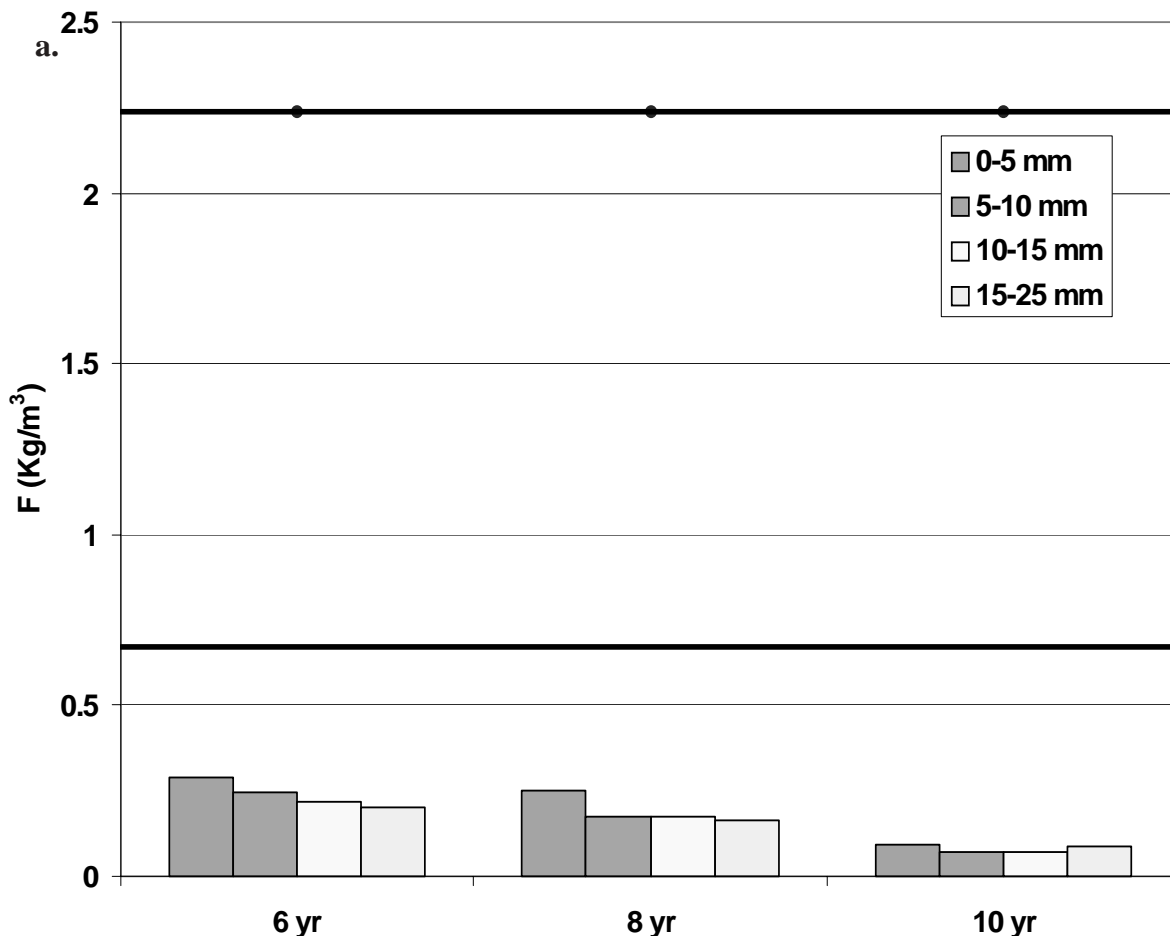

Figure IV-4. Residual a) fluoride and b) boron at selected distances from the surface 150 mm below the groundline in Douglas-fir poles 6 to 10 years after application of a fluoride/boron bandage.

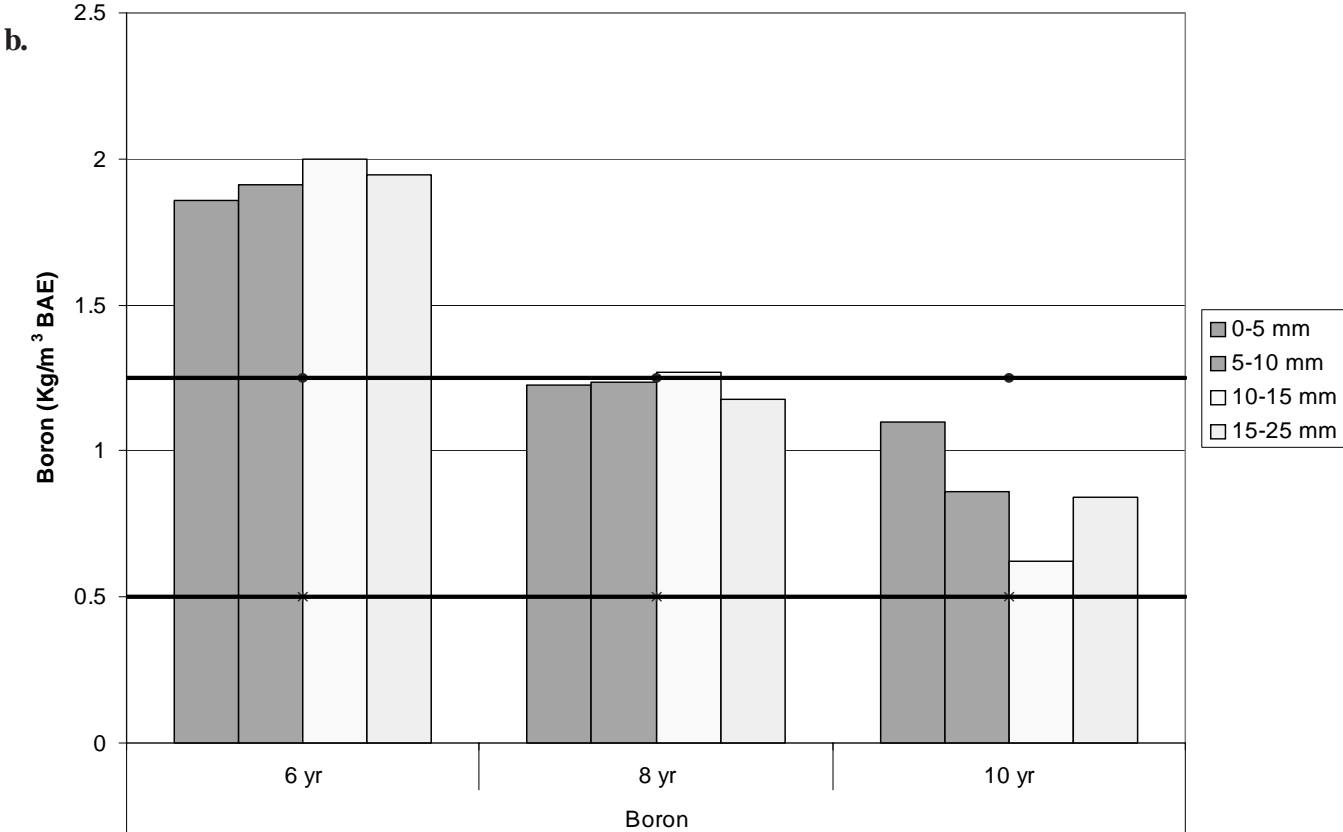

Figure IV-4. Residual a) fluoride and b) boron at selected distances from the surface 150 mm below the groundline in Douglas-fir poles 6 to 10 years after application of a fluoride/boron bandage.

*Objective V*

**PERFORMANCE OF COPPER NAPHTHENATE  
TREATED WESTERN WOOD SPECIES**

---

Copper naphthenate has been available as a wood preservative since the 1940's but the real commercial use of this system has only occurred in the last decade, as utilities sought chemicals that were less restrictively labeled. Copper naphthenate is currently listed as a non-restricted use pesticide, meaning that this chemical does not require special licensing. This has little bearing on the use of preservative treated wood, since there are no restrictions on who can use any of the preservative treated wood products currently on the market (although there are recommended applications for each product); however, many users have sought to soften their environmental image by shifting to alternative preservatives such as copper naphthenate.

Copper naphthenate has provided reasonable protection in a variety of field stake tests, but there is relatively little long term data on western wood species. To help develop this information, we established the following test.

Western redcedar sapwood stakes (12.5 by 25 by 150 m long) were cut from either freshly sawn lumber of the outer surfaces of utility poles that had been in service for approximately 15 years. Weathered wood was included in the test to explore the possibility of retreatment and reuse of poles removed from service. The latter poles were butt treated, but had not received any supplemental treatments to the above ground portion of the pole.

The stakes were conditioned to 13 % moisture content, then weighed prior to pressure treatment with copper naphthenate dilute in diesel oil to produce target retentions of 0.8, 1.6, 2.4, 3.2, and 4.0 kg/m<sup>3</sup>. Each retention was replicated on 10 freshly sawn and 10 weathered stakes. The stakes were then exposed in a fungus cellar maintained at 28 C and approximately 80 % relative humidity. Soil moisture was allowed to cycle between wet and dry conditions to avoid favoring soft rot attack (which tends to dominate in soils that are maintained at high moisture levels). The condition of each stake was visually assessed annually using a scale from 10 (completely sound) to 0 (completely destroyed). Stake ratings increased slightly at 120 and 140 months because they were evaluated by different researchers.

The stakes cut from freshly sawn sapwood continue to out-perform those cut from weathered wood at each retention level (Figures V-1, 2). Weathering is generally a surface effect, the stakes also tended to have numerous small checks that could act as pathways for chemical loss and fungal attack. Ratings for stakes cut from freshly sawn lumber tended to average between 8.0 and 10.0 after 172 months of exposure, while stakes treated with diesel alone rated approximately 2.6. The diesel stakes performed well for approximately 100 months, but then their condition declined precipitously. Untreated stakes have largely been destroyed. The diesel performance probably reflects the initial high loadings of solvent in these materials (80 to 90 kg/m<sup>3</sup>). In actual practice, post treatment steaming and other activities would reduce the amount of residual solvent slightly. Weathered stakes had consistently lower ratings 172 months after treatment. Diesel treated weathered stakes were nearly completely decayed, while the untreated controls had failed after 5 years of exposure with ratings ranging from 4.2 for the 0.8 kg/m<sup>3</sup> to 8.4 for the 4.0 kg/m<sup>3</sup> (Figure V-2).



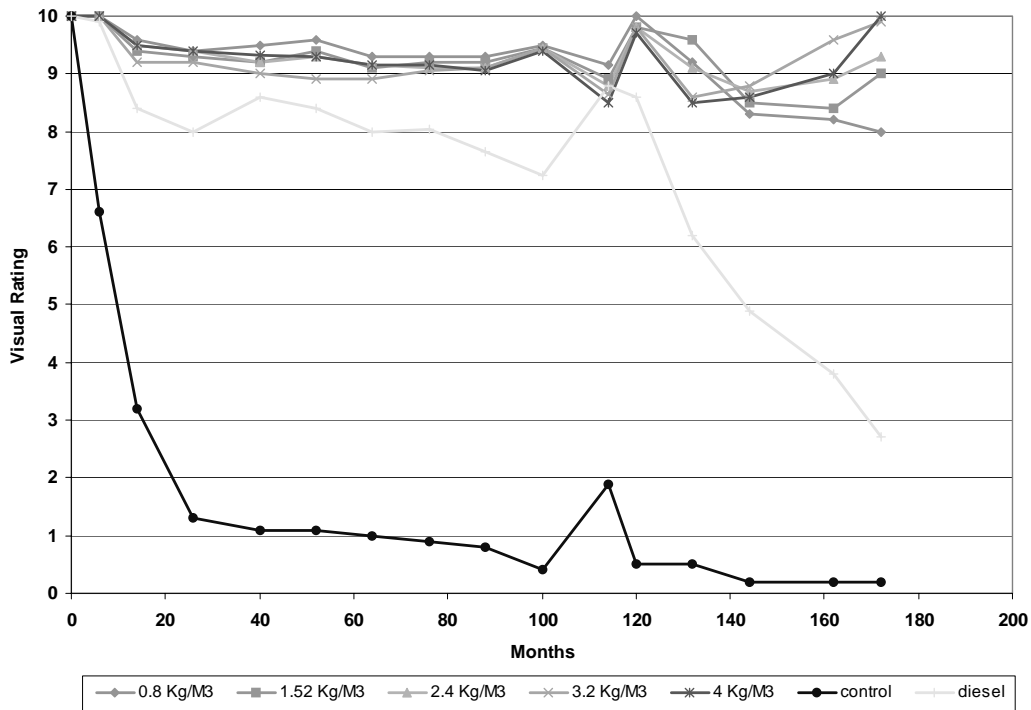

Figure V-1 Condition of freshly sawn western redcedar sapwood stakes treated with selected retentions of copper naphthenate in diesel oil and exposed in a soil bed for 172 months.

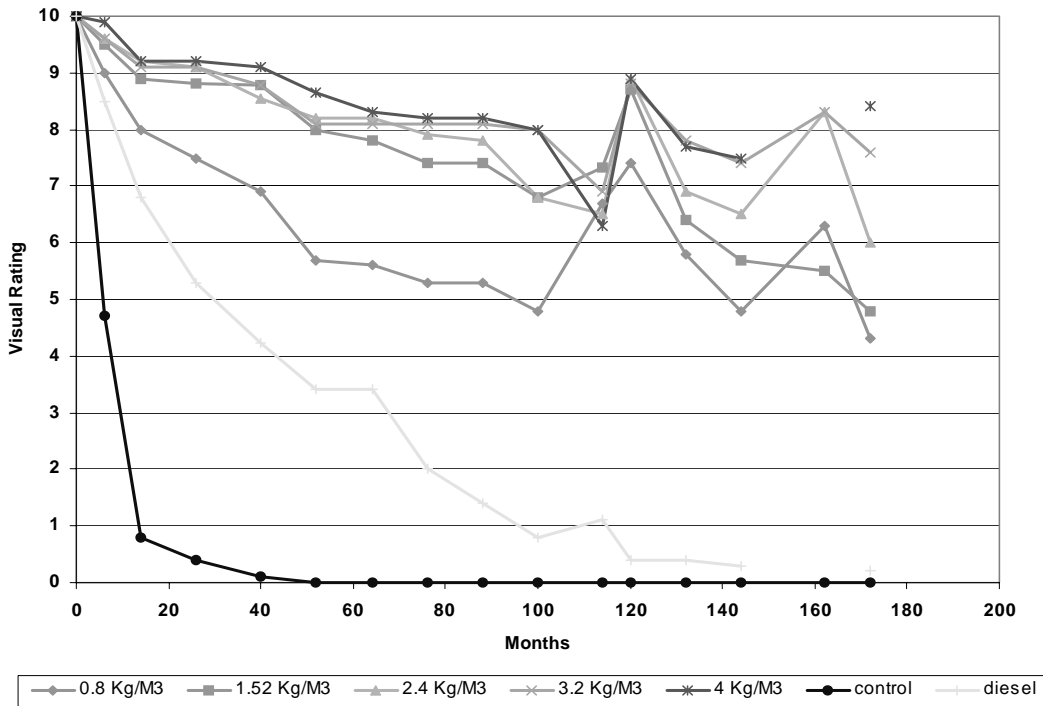

Figure V-2 Condition of weathered western redcedar sapwood stakes treated with selected retentions of copper naphthenate in diesel oil and exposed in a soil bed for 172 months.

The difference in condition of the diesel stakes in comparison with similarly treated stakes cut from freshly sawn lumber emerged early in the test and illustrates the effects of weathering on performance. Weathered wood was originally included in this test because the cooperating utility had planned to remove poles from service for retreatment and reuse in other parts of the system. While this process remains possible, it is clear that the performance characteristics of the weathered retreated material will differ substantially from that of freshly sawn material. The effects of these differences on overall performance may be minimal since even if the outer, weathered wood were to degrade over time, this zone is relatively shallow on cedar and would not markedly affect overall pole properties. The copper naphthenate should continue to protect the weathered cedar sapwood above ground, allowing line personnel to continue to safely climb these poles and any slight decrease in above ground protection would probably take decades to emerge. As a result, retreatment of cedar still appears to be a feasible method for avoiding pole disposal and maximizing the value of the original pole investment.

---

---

*Objective VI***ASSESS THE POTENTIAL ENVIRONMENTAL IMPACTS OF WOOD POLES**

---

Preservative treated wood poles clearly provide excellent service under a diverse array of conditions, but the increasing sensitivity of the general public to all things chemical has raised a number of questions concerning the preservatives used for poles. While there are no data indicating that preservative treated wood poles pose a risk to the environments in which they are used, it is important to continue to develop exposure data wherever possible. The goal of this objective is to examine usage patterns for preservative treated wood (specifically poles) and develop exposure data that can be employed by utilities to assess their use patterns and to answer questions that might arise from either regulators or the general public.

**A. Assess the Potential for Preservative Migration From Pentachlorophenol Treated Poles in Storage Yards**

In an ideal system, utilities would only receive poles as needed for specific activities; however, most utilities must stock poles of various sizes at selected depots around their system so that crews can quickly access poles for emergency repairs that result from storms or accidents. In previous studies, we examined the potential for decay in these stored poles and made recommendations for either regular stock rotation of poles so that no single pole was stored for longer than two to three years or for a system of periodic remedial treatment of stored poles to ensure that these structures did not develop internal decay during storage. These recommendations were primarily based upon long term storage, but there was little concern about the potential for any preservative migration during this storage.

The potential for preservative migration from stored poles has received little attention, but could be a concern where large numbers of poles are stored for long periods. Preservative present on the wood surface could be dislodged or solubilized during rain events and subsequent heating in sun could encourage further oil migration to the wood surface. There is, however, little data on the potential for migration of preservative from poles in storage. Treating plants have less concern about this issue because surface water from their sites are already regulated and must be treated prior to discharge (or be shown to contain less than permissible levels). Pole storage facilities, however, are not currently regulated, nor are there recommendations or best management practices that might help utilities minimize the potential for chemical loss.

The purpose of this section was to assess the levels of preservative migrating from pentachlorophenol treated Douglas-fir poles sections subjected to natural rainfall in Western Oregon with the ultimate goal of developing recommendations for pole handling and storage by utilities.

Douglas-fir poles sections (250 to 300 mm in diameter by 1.0 m long) were air-seasoned and pressure-treated with pentachlorophenol in P9 Type A oil to a target retention of 9.6 kg/m<sup>3</sup> in the outer 6 to 25 mm of the poles. Treatment conditions followed the current Best Management Practices as outlined by the Western Wood Preservers' Institute. Following treatment, one end of each pole was end sealed with an elastomeric paint designed to reduce the potential for chemical loss from that surface, while the other end was left unsealed. The idea was to simulate a longer pole section where some end-grain loss was possible, but the amount of exposed end-grain did not dominate the overall surface area exposed. Six poles were then stacked on stainless steel supports in a stainless steel tank designed so that all rainfall striking the poles would be captured.

The poles were set 150 mm above the tank bottom to reduce the risk that the wood would be submerged and, therefore, have the potential to lose more chemical. The poles were then exposed outside the Richardson Hall laboratories where they were subjected to natural heating and rainfall. We allowed this system to operate for approximately 1 year, then we removed the poles, cleaned the system and reset the tank so that different pole surfaces were exposed.

**a.**



**b.**



Figure VI-1. Photo showing the two 6 pole configurations a)configuration 1 and b) configuration 2 evaluated in our small scale preservative migration chamber.

The tank was sampled whenever there was measurable rainfall by draining all of the water collected in the tank bottom as soon as possible after the rainfall event had concluded, or daily when storms continued for more than one day. In some cases, the rainfall, while measurable, did not result in collectible water samples because the conditions were so dry prior to the rainfall that the falling moisture was either sorbed by the wood or evaporated. In addition, early in the process, it became obvious that debris (primarily leaves) was falling into the tanks between collections. Since these materials had the potential to sorb any chemical solubilized by the rainfall, we placed a large mesh screen around the tank to limit the potential for debris entering the tank, while still allowing rainfall to strike the wood.

Tank sampling involved collecting all liquid and weighing this material. Approximately 230 ml of this material was then retained for penta (PCP) analysis. Two extractions were required for the separation of PCP from an oil contaminated aqueous environment. The aqueous sample, or filter solid, was first adjusted to a high pH with sodium hydroxide to form pentachlorophenate anion in the aqueous phase. An extraction with iso-octane then removed the petroleum oil residues from the water phase, leaving the PCP in the aqueous phase. The water phase was then acidified, converting the pentachlorophenate back to pentachlorophenol. A second extraction with iso-octane now removed the PCP from the aqueous phase. This second extraction was analyzed for PCP content using high resolution gas chromatography with low resolution mass spectrometer detection system (HRGC-LRMS).

#### Reagents:

- a. DI water: Deionized water from Richardson Hall DI water line
- b. Sodium Hydroxide: VWR, reagent grade
- d. Hydrochloride acid: JT baker, Baker analyzed
- e. Ethanol: McCormick, absolute-200 proof
- f. Iso-octane: Fisher, Optima grade
- g. Methanol: Fisher, HPLC grade
- h. Pentachlorophenol: Aldrich, 98%
- i. [ $^{13}\text{C}_6$ ] labeled Pentachlorophenol: Cambridge Isotope Laboratories 99%, internal standard (IS)
- j. P9A oil (Imperial): Shell, 124 process

*Extraction from base:* A 50  $\mu\text{L}$  portion of 200  $\mu\text{g}/\text{mL}$  IS was spiked into the two volumetric flasks. Then 2.4 mL 0.1N NaOH was added to each of the two flasks using an Oxford pipette yielding a pH of approximately 11. Water was added to bring the total volume to the bottom of the neck of the volumetric flask. The flasks were placed on a stirring plate. The stirring speed was increased until a vortex was obtained and continued for 1 minute. The flasks were then allowed to stand for 30 minutes, after which 2.4 mL of iso-octane was added to the #1 flask using a bottle top dispenser. Both flasks were stirred for one minute. The solvent layer was removed with a disposable glass pipette and discarded. The stirring and separation were repeated; except the stirring time was reduced to 30 seconds and 2.0 mL iso-octane was added. After the second separation, the weight of the two flasks was recorded. A 3 mL aliquot of aqueous solution was removed with an Oxford pipette.

*Extraction from acid* The solutions were acidified to a pH of approximately 3 by adding 3 mL of 0.5M  $\text{H}_2\text{SO}_4$  to the flask with an Oxford pipette. The flask was stirred for 1 minute and allowed to stand for 30 minutes, then 2.4 mL of iso-octane was added. The flask was stirred for 1 minute. The extract was collected using a new glass pasture pipette and transferred to 20 mL HRGC-LRMS vials. The procedure was repeated; except using 2.6 mL of solvent and 30 seconds stirring. The second extract was transferred to the same vial as the first and mixed.

*HRGC-LRMS analysis:* The HRGC-LRMS analysis was carried out on a Shimadzu HRGC-LRMS system class 5000 with injector AOC-17 and capillary column XTI-5 from Restek. This column is composed of fused silica with a 0.25 mm thick film of 95% dimethyl, 5% diphenyl polysilarylene. The column dimensions were 0.25 mm ID X 30 m long.



## HRGC parameters

Carrier gas: Helium grade 5.0

Flow rate: 1.2 mL/min

Split rate: 5

Injector temperature: 250°C

Detector interface temperature: 280°C

Temperature program: 2 min. hold, 35°C to 260°C at 25°C/min.,

Injection volume: 1 uL

Solvent wash: methanol

The National Institute of Science and Technology (NIST) Mass Spectral Library #107 software was installed on the system. The PCP standard (50 ug/mL) and [<sup>13</sup>C<sub>6</sub>] PCP internal standard (50 ug/mL) were scanned and identified by the Library search function of the HRGC-LRMS instrument. The retention time for PCP was 9.70 min. The selected ion for PCP quantitative analysis was m/z = 266, the reference ions were 264 and 268. The selected ion for the internal standard [<sup>13</sup>C<sub>6</sub>] PCP was m/z = 274, the reference ions were 276 and 172.

HRGC-LRMS auto-tuning was performed with perfluorotributylamine. The calibration was carried out with PCP concentrations of 0.1, 0.2, 0.5, 1.0, 2.0, 5.0, 10.0, and 20.0 ug/mL; 2 ug/mL IS was added for each standard solution or sample. Five point calibration was employed, i.e., for each single batch a minimum of five consecutive standards were selected depending on the range of concentration of the samples.

Each sample was diluted to bring the PCP concentration into the selected calibration range. Linear regression software was chosen for the calculation of the calibration curve.

The volume of water collected was measured by weight. A density of 1.00 g/mL was used for water. The limit of detection (LOD) of this method was estimated to be 0.025 ng/mL cm<sup>2</sup>. The LOD is defined according to Part 136, Appendix B, procedure (b) (Federal Register, 1984), as three times the standard deviation of replicate analyses of the analyte.

Penta levels in runoff from the stored poles in the original 6 pole alignment ranged between 1 and 2.5 ug/mL of water over 62 rainfall events (Figure VI-2). Penta levels in the runoff from the first 6 rainfall events were lower than almost all other samples; however, there was a delay in analysis of these samples and we believe the lower levels were due to degradation or sorption of the penta during storage time. The remaining samples were processed within 3 days of collection, limiting the potential for degradation or loss in storage. The relatively narrow range of concentrations suggests that penta solubilization in rainwater is relatively predictable. Penta levels in the runoff from 13 rainfall events for the realigned 6 pole stack were slightly higher than those in the original 6 pole stack (2.3 to 2.9 ug/mL of water) (Figure VI-2), but the differences were small.

In addition to the apparent lack of concentration change with time or pole configuration, the total amount of rainfall did not appear to affect the runoff concentration for either pole stack configuration. Instead, increased rainfall was associated with an overall increase in total penta migration, but the runoff concentrations did not vary (Figure VI-3). These results suggest that migration from the poles is a function of water contact with the pole and penta solubility in the rainwater. The similarity in runoff concentrations over time suggests that losses can be predicted based upon the rainfall

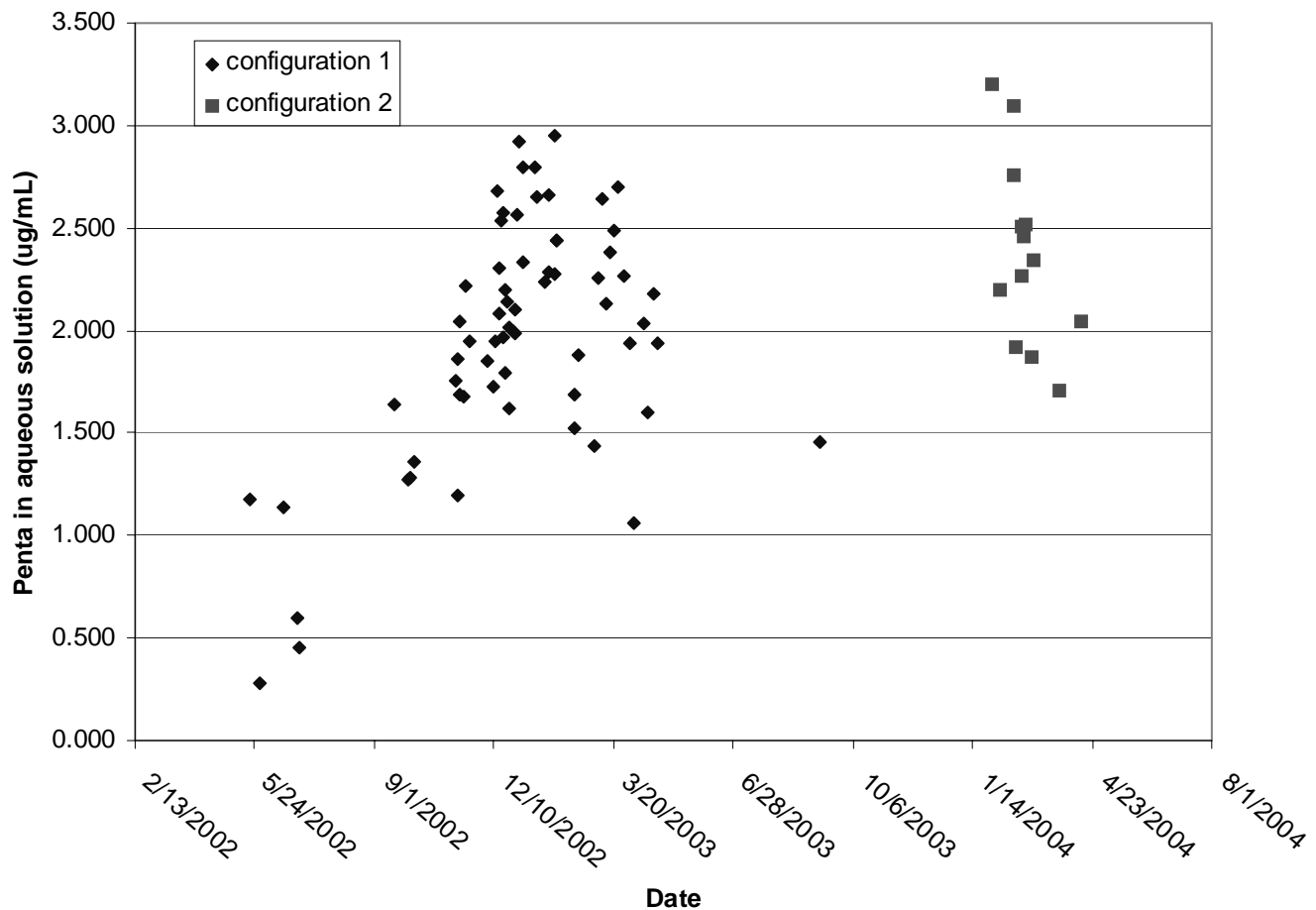

Figure VI-2. Penta concentrations as a function of sampling date in leachate collected from penta treated Douglas-fir poles following rainfall events over a 2.5 year exposure period showing data for two configurations of poles.

amounts and total surface area exposed to direct rainfall to some limit (i.e. at some point penta concentrations would reach saturation and increasing pole surface area would not impact subsequent levels).

Another factor that was assessed was whether time between rainfall events affected penta concentrations in the runoff. Long term storage in the absence of precipitation might allow chemical to migrate to the surface, where it would be more prone to migration. Once again, however, the time between rainfall events appeared to have little effect on runoff concentration (Figure VI-4). This effect is clearly illustrated by the final sampling of the six stack configuration in September 2003 where the previous measurable rainfall event was 5 months prior to the sampling, yet runoff concentrations were similar to those found in the wet season. These results suggest that penta migration from poles is more affected by the exposed surface area and total rainfall than other environmental factors such as temperature.

The total area exposed on the pole sections in the 6 pole configuration was approximately 6.21 square meters including the ends. A large proportion of this surface was on the underside of the poles and was not actually exposed to rainfall. While small streams of water flowed over these under-surfaces, the actual area exposed to potential rain contact was estimated to be approximately 5.3 square meters. If we convert our six short pole sections to 6 Class 4 forty-foot poles, we would multiply our total penta losses by approximately 12 to arrive at the amount of migration from these poles. We collected a total of 1910 mg of penta from all of the rainfall events. This would translate to a total of 22.9 g of penta for the poles over the past year. A typical Douglas-fir pole would contain approximately 2.89 kg of penta (calculated by considering 25 mm thick treatment zone and multiplying this volume by an assumed 9.6 kg/m<sup>3</sup> retention) and the six poles would contain 17.34 kg of penta. This translates to a loss of 0.13 % of the total available penta in the approximately 2.5 year exposure period.



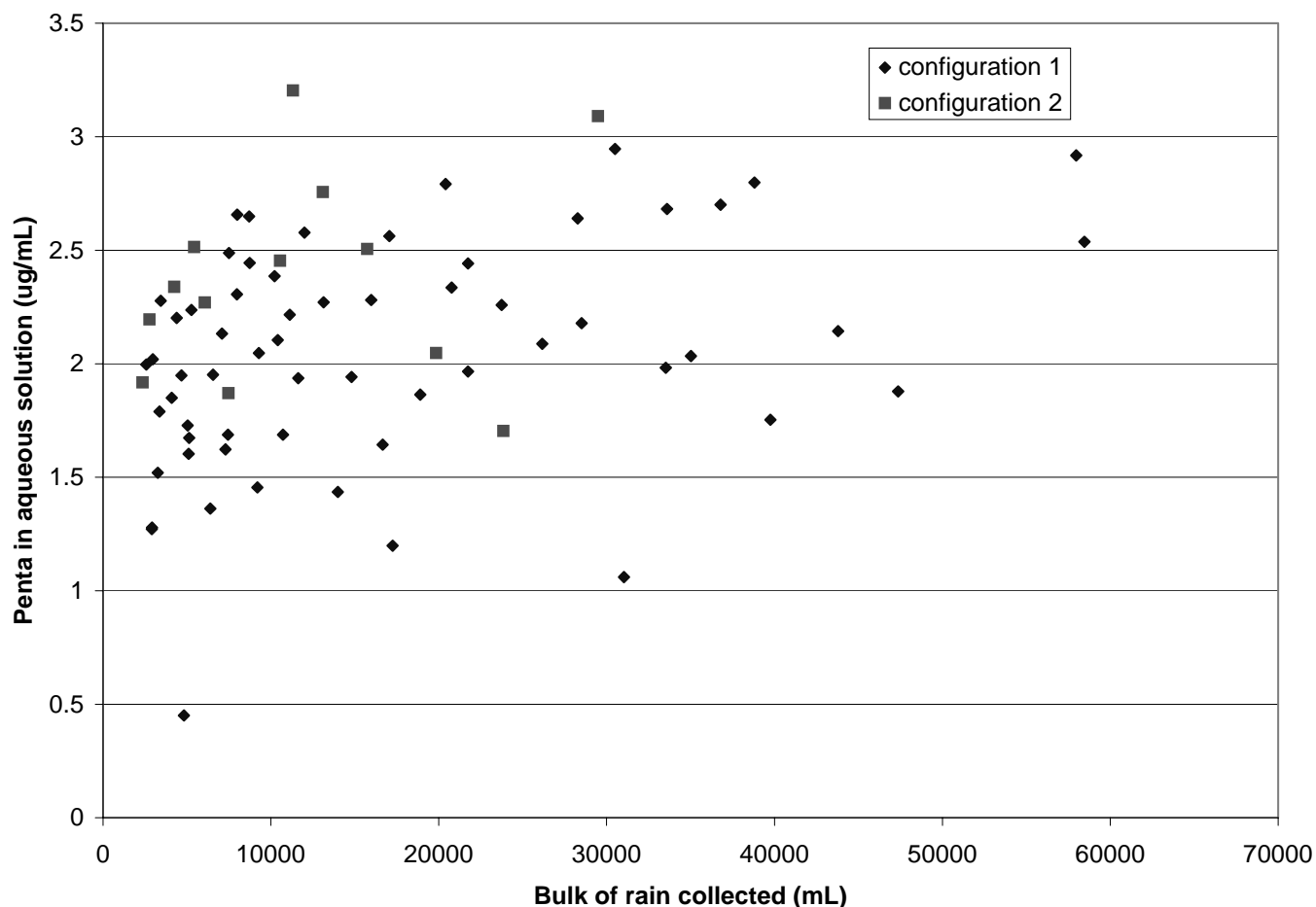

Figure VI-3. Penta concentrations as a function of total amount of rainfall collected in leachate from penta treated Douglas-fir poles following rainfall events over a 2.5 year exposure period showing data for two stacking configurations of poles.

An additional factor to consider in these calculations is the potential flow paths on poles in solid piles. In our tests, the poles were stacked in tiers which tended to protect the lower poles from wetting. In a larger stack, this protective effect would be even greater. Thus, it may be possible to examine the potential for loss on the basis of the exposed upper portions of the stack rather than considering all poles in an individual stack. We plan further tests of poles stacked in different configurations to determine which storage practices minimize the potential for loss of chemical.

The initial evaluations clearly show that penta can migrate from stored poles, a finding supported by previous studies in aquatic environments. Unlike aquatic environments, however, the migrating chemical winds up in the soil beneath the poles where it can be trapped and slowly degraded. There is also the potential for application of absorbent materials beneath the storage area to capture any migrating chemical. These materials could then be removed from the site once the operations are completed. As a result, the loss of chemical should have minimal impact on the surrounding environment. Our data also suggests that stacking poles to minimize the area exposed to rainfall is probably an effective approach to limiting preservative migration. Spreading poles out allows more rainfall to strike pole surfaces, solubilizing a proportionally higher total amount of penta. In addition, pole rotation (i.e. last in first out inventory approaches) does not appear to affect losses which appear to be largely driven by the solubility of penta in water. In previous studies (Annual Report ) we have advocated for regular rotation of stored poles to avoid the development of deep checks and limit the potential for internal decay development during prolonged storage. Our current findings should not affect that recommendation.

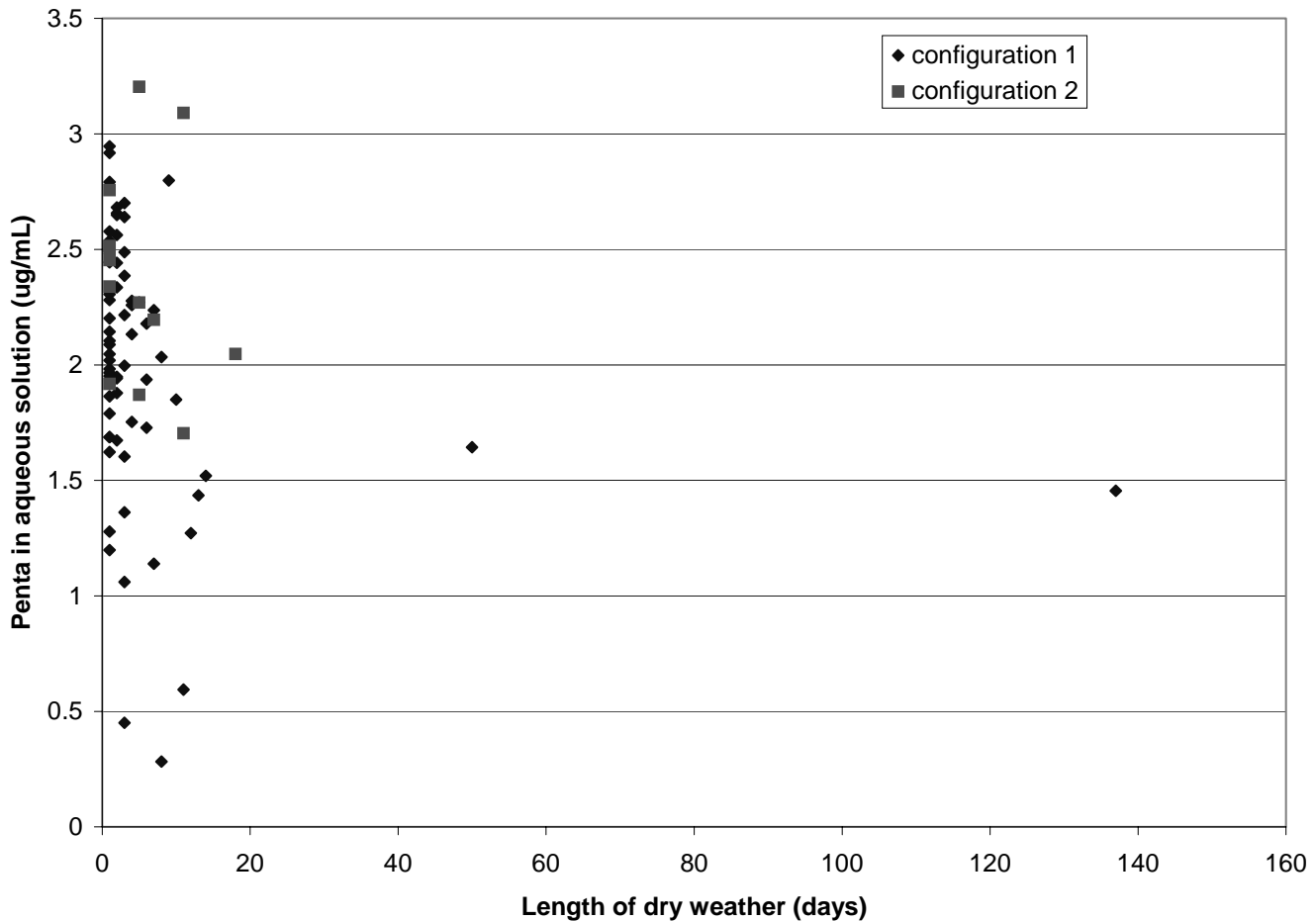

Figure VI-4. Penta concentrations as a function of intervals between collections (# of dry days) in leachate collected from penta treated Douglas-fir poles following rainfall events over a 2.5 year exposure period showing data for two stacking configurations of poles.

We will continue our tests using other poles and different storage configurations to better understand the primary factors that affect migration. These data will be used to develop more accurate storage recommendations to minimize potential releases of chemical into the environment.

### B. Chemical migration from poles treated with inorganic salt preservative systems

While pentachlorophenol continues to be one of the dominant wood preservatives used by electric utilities across North American, a number of utilities have substituted waterborne, metal-based preservatives including chromated copper arsenate (CCA) or ammoniacal copper zinc arsenate (ACZA) in their systems. The recent shift from CCA to the alternative alkaline copper based systems for residential applications will not affect these usages, but one concern that may arise in this process is how a homeowner can not obtain wood treated with this chemical, but a utility could place a pole treated with the same chemical into their back yard. Given the sensitivity of the public to any chemical, we believe that developing data showing the minimal risks associated with metal preservatives in poles will prove useful for answering those questions. One important question is how much and how far do CCA components migrate from poles into the surrounding soil.

While we could establish field plots of test poles, these tests take time to develop. Instead, we elected to look for existing field tests of CCA that could be sampled to assess chemical movement. The advantage of this approach is the ease of sampling as well as the tendency for the material in field tests to be more closely controlled in terms of treatment and prior record keeping. We were fortunate to develop a working relationship with Dr. Jacob Huffman, Professor Emeritus at the University of Florida who manages the field test site at the Austin Carey Memorial Forest near Gainesville, Florida. Most of the major chemical companies operate test sites at this location and there is a wealth of older test materials in place that could be used to examine a variety of wood performance issues. Among these tests is an older CCA test on southern pine. The posts were treated with CCA Type A, a more mobile form of CCA, but they can still serve as a measure of metal migration through soil.

Several CCA formulations are listed in the Standards of the American Wood Preservers' Association (AWPA, 1999), but the most commonly used CCA formulation contains approximately 47.5% chromium trioxide, 18.5% cupric oxide, and 34.0% arsenic pentaoxide (CCA Type C)(AWPA, 1999). CCA is normally specified on an oxide basis, and translating these to elemental levels would result in one kg of CCA containing 247 g of chromium, 146 g of copper and 163 g of arsenic. The treatment in the wood is typically expressed on a biocide weight per wood unit volume basis. For residential soil contact applications, the CCA retention is specified to be 6.4 kg/m<sup>3</sup> on an oxide basis. As a result, each cubic meter of treated wood contains 1.58 kg of chromium, 0.93 kg of copper and 1.04 kg of arsenic on a metal basis.

CCA normally undergoes a series of reactions with wood following treatment. The chromium is reduced, copper reacts with both the wood and the chromium and the arsenic reacts with both the chromium and copper (Dahlgren and Hartford, 1972 a, b, c; Dahlgren, 1974; Pizzi, 1982). The most easily measured reaction is the reduction of hexavalent chromium and tests have been developed for detecting this chemical in wood. The reaction rates differ with wood species and treatment solution concentrations, but the most important factor is temperature. Fixation usually occurs within days at warmer temperatures, but fixation can pose a major challenge for treaters operating in colder climates.

While fixation was long viewed as permanent, CCA components do migrate from the wood over time (Cooper, 1994; Cooper and Ung, 1994; Jin et al., 1992). The most significant losses occur shortly after installation when unfixed components on the surface leach into the surrounding environment. The losses from CCA treated wood have generally been studied by water immersion, owing to greater concerns about the risks of copper to aquatic organisms. Migration into soil surrounding treated wood has received far less attention.

Migration of preservatives into soils surrounding treated wood is not a new concern (Mortimer, 1991). Murarka et al. (1996) studied pentachlorophenol (penta) in soil around penta-treated utility poles and found little evidence of migration beyond 300 mm from the poles. The recent concerns about the use of CCA-treated wood in Florida have highlighted the lack of data on migration of CCA components from treated wood into soil (Matus, 2001; Solo-Gabriele et al., 1999; Townsend et al., 2000; Conklin, 2001). While such data can be developed by installing freshly treated, properly fixed wood into soil and monitoring subsequent metal levels, this approach takes too long to supply meaningful data in the time required by regulators to make informed decisions concerning the handling of wood treated with this preservative. An alternative to developing new data is to take advantage of materials that have been previously installed. In most cases, this material is unsuitable for testing because of the lack of adequate characterization prior to installation. The exceptions are field tests that have been used to develop new preservatives. The Austin Cary Forest at the University of Florida is fortunate to be the site where most of the wood preservatives developed over the past 50 years have been evaluated prior to commercialization. While many of the systems tested are proprietary, some of the tests are public and contain test samples that could be used to assess preservative migration into soil over time. Among these tests are a 1954 test of CCA treated posts and a 1957 test of CCA treated dimension lumber stakes.

---

In this report, we assessed metal levels in soil surrounding and beneath CCA treated wood as well as in the wood from these two tests.

Southern pine posts that had been treated to a retention of either 8 or 12 kg/m<sup>3</sup> with a formulation of chromated copper arsenate similar to the currently used Type B, were installed at the Austin Cary Memorial Forest in 1954. CCA Type B contains higher levels of arsenic and lower levels of chromium than the more commonly used Type C formulation. This should make the system less strongly fixed and more prone to metal losses. The posts were part of a larger evaluation of CCA. One half of the posts had been in the plot for the entire 47-year exposure period, while the remainder had been removed for 7 months (the posts were stolen), set into another site, then recovered and returned to their original holes. Although the removed posts were set into their original holes, it was impossible to avoid some soil disturbance around the holes. As a result, we might expect slightly different soil metal characteristics around these posts.

The test site is typical of northern Florida scrub forest and contains palmetto and other brush beneath a southern pine and mixed hardwoods overstory. The soil has been described as poorly drained, siliceous, hyperthermic and ultic haploquod of the Pomona Sand Series. The surface pH measured 4.47 and the water holding capacity was 8%. The A horizon (0 to 100 mm) was dark grey sand (Munsell Color Notation: 10 YR 3/1), having a weak fine crumb structure, very friable and extremely acidic. The E1 horizon (100 to 500 mm) was grey sand (10 YR 7/2) single grained, loose and also strongly acidic. The next layer (500 to 650 mm) was dark brown (5 YR 2.5/2), sand, moderate to granular structure. This layer adsorbs significant amounts of trace metals due to the organic materials and aluminum. The E2 horizon extends from 650 to 1500 mm (10 YR 8/1), was single grained, loose and light colored and has little ion retention capacity. The 1500 to 1800 mm layer was tan/yellow (2.5Y 6/2) silt/clay that absorbs metals due to its high surface area. This layer had distinct brownish yellow mottles (10 YR 7/8). The site was hand cleared of palmetto prior to sampling, taking care to minimize surface disturbance.

Sixteen posts were selected for study. Eight of the posts had been treated to an initial retention of 8 kg/m<sup>3</sup> while the remainder had been treated to 12 kg/m<sup>3</sup>. Four of the posts in each treatment group had been at the original site since installation, while the remainder had been removed and reinstalled as described earlier.

The soil around each post was sampled using a soil auger, with soil samples collected based upon both horizontal distance away from the wood and vertical depth at that horizontal location. Soil cores were removed from three equidistant locations around each post immediately adjacent to the wood, as well as 150 mm and 300 mm away. Soil in individual cores was collected from depth zones corresponding to 0-25, 150-175, 300 to 325, and 425 to 450 mm from the surface. The three samples from the same depth and distance from the post were combined for a given post. In addition to the radial sampling pattern, two posts (treated to 12 kg/m<sup>3</sup>) were carefully removed from the ground and the soil auger was used to remove soil from directly beneath the posts as well as 300 mm and 1200 mm below the post to determine if metal losses were potentially higher from the end grain of the wood in direct soil contact. The end-grain of the post should absorb higher levels of initial treatment which might be more vulnerable to migration into the soil. In addition, the post would protect any migrating chemicals from downward water flow through the sandy soil.

In addition to the post sampling, four 2 by 4 by 18 inch stakes treated to 23-24 kg/m<sup>3</sup> with CCA and installed in 1957 were sampled by removing the stakes and using the soil auger to collect soil samples from immediately below the stake, and 450 mm, 900 mm, and 1350 mm below the end of the stake.

In addition to soil samples, 50 mm long increment cores were removed from the posts at sites approximately 150 mm below groundline and 300 mm above groundline. These cores were divided into the outer and inner halves. Three increment cores were taken from each height for each post.

Background metal levels in soil were assessed by digging a soil pit away from any of the stake tests. Samples were collected from the surface, then approximately 300, 600 mm, 900 mm, and 1200 mm beneath the surface. The 900 mm layer coincided with an alumina layer that was believed to contain higher levels of soil minerals.

The soil samples (10 g) were extracted in 20 ml of 0.025 M diethylenetriaminepentaacetic (DTPA) for 2 hours on a mechanical shaker (Anonymous, 1989). The extract was filtered through Whatman No. 42 filter paper, then the resulting extract was analyzed for metal content by ion coupled plasma spectroscopy and the results were compared with prepared standards as well as a blank sample containing only DTPA.

Wood samples were microwave digested and analyzed according to previously described procedures (Gaviak et al., 1994). Briefly, 500 mg of material was placed in a 120 ml teflon digestion vessel. 0.5 ml of trace metal grade concentrated nitric acid and 2 ml of 30 % hydrogen peroxide were added to each vessel, then the samples were predigested for 30 minutes. The samples were then capped and microwaved for 4 minutes at 296 watts, then 8 minutes at 565 watts. The samples were transferred to a centrifuge tube and the volume was adjusted to 15 ml with dionized water. The samples were then analyzed by ICP as described above.

The soil analyses were subjected to an ANOVA using a General Linear Model to determine if the differences in metal levels around the posts differed statistically with depth and distance for posts treated to a given retention.

Copper, chromium and arsenic levels in the control soil pit were all uniformly low, a finding that is consistent with the inability of sandy soils to sorb and retain metals. Interestingly, even the alumina layer at about 100 mm from the surface had relatively low metal levels. We originally excavated to this depth with the understanding that this layer would tend to sorb any metals that moved downward in the soil column (Table VI-1). These low metal levels suggest that either little metal migrated downward or that this layer was unable to trap the metals.

Table VI-1. Copper, chromium, and arsenic levels at selected depths in a soil pit dug in native soils in the Austin Cary Memorial Forest located away from any possible source of CCA.			
Sampling Depth (mm)	Metal Level (ppm)		
	Copper	Chromium	Arsenic
0-25	0.40	<0.02	0.13
300-325	0.10	<0.02	<0.05
600-625	0.10	0.04	0.21
900-925	0.10	<0.02	0.38
1200-1225	0.10	<0.02	<0.05

*Preservative levels in posts:* The posts were originally treated to target retentions of 8 and 12 kg/m<sup>3</sup>, both levels that exceed the currently recommended 6.4 kg/m<sup>3</sup> for wood used in soil contact for residential construction (Table VI-2). Preservative levels tended to be higher in the outer 12 mm of the posts than in the next 37 mm, but none of the levels approached the original respective target retention. The presence of elevated preservative levels on the surface suggests that extensive depletion of preservative components has not occurred since depletion is most likely to occur nearer the wood surface. The differences in surface retentions between the below and above-ground samples, however, suggest that some depletion has occurred over the prolonged exposure.

Retention (kg/m <sup>3</sup> )	Distance	Assay Zone	Metal Retention (kg/m <sup>3</sup> ) <sup>a</sup>										
			As <sub>2</sub> O <sub>5</sub>		CrO <sub>3</sub>		CuO		Total				
8.00	Original	(150.00)	inner	0.53	(0.58)		1.07	(1.07)		0.65	(0.54)	2.24	(2.19)
			outer	0.96	(0.63)		1.92	(0.78)		0.70	(0.10)	3.58	(1.51)
	300.00	inner	1.08	(1.07)		0.65	(0.66)		0.29	(0.30)	2.02	(2.03)	
		outer	1.99	(0.95)		1.79	(0.77)		0.97	(0.37)	4.74	(2.09)	
	Replaced	(150.00)	inner	0.57	(0.45)		1.15	(0.67)		0.93	(0.32)	2.65	(1.45)
			outer	0.84	(0.33)		2.09	(0.43)		0.68	(0.22)	3.60	(0.98)
12.00	Original	(150.00)	inner	0.86	(0.73)		1.39	(0.75)		1.10	(0.72)	3.34	(2.19)
			outer	2.72	(1.68)		3.67	(1.67)		0.86	(0.34)	7.26	(3.68)
	300.00	inner	2.30	(1.41)		1.28	(0.73)		0.72	(0.46)	4.30	(2.60)	
		outer	3.52	(1.87)		3.09	(1.62)		1.51	(0.83)	8.12	(4.33)	
	Replaced	(150.00)	inner	1.76	(0.57)		1.97	(0.48)		1.39	(0.50)	5.11	(1.54)
			outer	3.86	(1.36)		4.33	(0.95)		1.25	(0.40)	9.43	(2.71)
	300.00	inner	2.74	(1.43)		1.49	(0.75)		0.82	(0.40)	5.05	(2.57)	
		outer	4.98	(1.40)		4.01	(0.90)		2.10	(0.63)	11.09	(2.92)	

*Metal Levels in Soil Around Posts:* Soil types can strongly influence metal solubility, although the effects do not necessarily mean that preservative components will migrate differently in differing soils (Schultz et al., 2002; Cooper et al., 2001; Wang et al., 1998). Copper tended to be present at the highest levels of all three elements, particularly near the soil surface immediately adjacent to the posts. Copper levels declined over 6 fold from the upper surface to the deepest sampling zone nearest the posts (Significant, p value < 0.0001), but these levels were still well above the background level found in the soil pit (Tables VI-1, 3).

Retention (kg/m <sup>3</sup> )	Original/ Replaced	Residual Metal Level (ppm)											
		0-25 mm from pole				150 mm from pole				300 mm			
		0-25 mm	150-175 mm	300-325 mm	450-475 mm	0-25 mm	150-175 mm	300-325 mm	450-475 mm	0-25 mm	150-175 mm	300-325 mm	450-475 mm
8	Original	253.5 (137.3)	39.5 (23.0)	31.0 (6.5)	25.9 (19.0)	17.9 (17.4)	1.5 (0.7)	1.00 (0.8)	1.5 (1.0)	1.5 (0.9)	1.1 (0.2)	2.8 (3.9)	1.2 (0.9)
	Replaced	144.4 (70.0)	36.0 (25.3)	30.0 (22.6)	32.0 (20.70)	7.8 (6.0)	5.7 (5.7)	2.4 (1.7)	4.9 (3.6)	1.6 (0.1)	3.8 (4.5)	5.6 (6.9)	5.9 (8.1)
12	Original	301.0 (301.3)	28.5 (27.7)	28.0 (19.2)	15.8 (12.3)	3.2 (1.9)	1.3 (0.7)	0.9 (0.5)	2.0 (2.9)	2.2 (1.9)	0.3 (0.2)	1.5 (1.8)	0.9 (0.9)
		201.4 (147.2)	33.7 (26.2)	41.2 (13.1)	24.6 (12.7)	19.5 (18.6)	3.0 (3.9)	2.3 (2.4)	5.8 (6.6)	1	<0.1	0.4	1.4



Copper levels in soil were significantly higher around posts treated to higher retentions. Copper levels 150 mm away from the posts declined significantly from those immediately adjacent to the posts. The copper level was nearly 15 fold lower at the surface 150 mm away from the pole than found at the same depth next to the pole. Copper levels below the surface also declined sharply with increased distance from the pole. Copper levels 300 mm away from the posts were again lower at the surface, but copper levels deeper in the soil were similar to those found at corresponding zones 150 mm away from the post. The lack of further declines in copper level with distance from the post may reflect the close proximity of the posts in the plots. The posts were generally set approximately 0.9 m apart in rows, but some posts were closer together and it is possible that chemical migration from one post may have overlapped with that of an adjacent post.

Chromium levels were generally low for all of the soil locations and depths sampled and ranged from 0.36 to 0.72 ppm immediately adjacent to the high retention posts and 0.47 to 1.02 ppm next to the low retention posts (Table VI-4). Chromium levels were at background levels 150 and 300 mm away from the posts. As with copper, the chromium levels decreased significantly with distance away from the post and depth beneath the surface, for each retention. The low chromium levels in the soil reflect the strong reactions of this metal with the wood. As a result, we would expect little chromium to be present in the surrounding soil.

Table VI-4. Chromium levels in soils at selected depths and distances from southern pine posts treated with chromated copper arsenate.<sup>a</sup>

Retention	Original/ Replaced	Residual Metal Level (ppm)											
		0-25 mm				150 mm				300 mm			
		0-25 mm	150- 175 mm	300- 325 mm	450- 475 mm	0-25 mm	150- 175 mm	300- 325 mm	450- 475 mm	0-25 mm	150- 175 mm	300- 325 mm	450- 475 mm
8.0	Original	0.47 (0.09)	0.94 (0.33)	0.76 (0.14)	0.85 (0.32)	0.09 (0.08)	0.05 (0.02)	0.07 (0.05)	0.11 (0.08)	0.03 (0.01)	0.05 (0.03)	0.05 (0.03)	0.03 (0.02)
	Replaced	0.54 (0.28)	0.77 (0.21)	0.70 (0.11)	1.02 (0.38)	0.09 (0.03)	0.15 (0.19)	0.05 (0.02)	0.07 (0.02)	0.06 (0.05)	0.06 (0.02)	0.04 (0.00)	0.04 (0.02)
12.0	Original	0.50 (0.26)	0.40 (0.28)	0.36 (0.18)	0.27 (0.03)	0.04 (0.02)	0.05 (0.03)	0.07 (0.05)	0.03 (0.01)	0.04 (0.03)	0.03 (0.02)	0.03 (0.01)	0.05 (0.03)
	Replaced	0.46 (0.10)	0.72 (0.51)	0.62 (0.16)	0.44 (0.19)	0.08 (0.04)	0.03 (0.01)	0.03 (0.01)	0.08 (0.05)	0.03	0.02	0.02	0.03

Arsenic levels were elevated immediately adjacent to the posts near groundline, then declined with both depth and distance (Table VI-5). These differences, however, were not significant. Elevated arsenic levels immediately adjacent to the posts was not surprising, given the high initial levels of arsenic in the preservative. Background arsenic levels ranged from 0.13 to 0.38 ppm. Arsenic levels 150 and 300 mm from the posts were similar to or slightly above the background level.

Table VI-5. Arsenic levels in soils at selected depths and distances from southern pine posts treated with chromated copper arsenate.<sup>a</sup>

Retention	Original/ Replaced	Residual Metal Level (ppm)											
		0-25 mm				150 mm				300 mm			
		0-25 mm	150-175 mm	300-325 mm	450-475 mm	0-25 mm	150-175 mm	300-325 mm	450-475 mm	0-25 mm	150-175 mm	300-325 mm	450-475 mm
8	Original	8.19 (9.73)	3.59 (4.25)	2.06 (1.88)	2.88 (3.37)	0.50 (0.38)	0.17 (0.10)	0.20 (0.11)	0.39 (0.41)	0.21 (0.19)	0.16 (0.04)	0.24 (0.21)	0.15 (0.09)
	Replaced	1.41 (0.28)	0.91 (0.34)	0.94 (0.31)	3.07 (3.10)	0.31 (0.17)	0.18 (0.15)	0.11 (0.05)	0.67 (0.61)	0.20 (0.02)	0.13 (0.00)	0.34 (0.24)	0.22 (0.16)
12	Original	7.16 (8.36)	2.19 (3.34)	1.74 (2.27)	3.34 (2.48)	0.45 (0.42)	0.43 (0.60)	0.68 (0.51)	0.37 (0.48)	0.35 (0.41)	0.26 (0.36)	0.80 (1.26)	0.32 (0.23)
	Replaced	2.18 (1.33)	3.09 (4.21)	2.19 (2.35)	1.76 (2.08)	0.77 (0.99)	0.09 (0.03)	0.15 (0.16)	0.49 (0.42)	0.15	0.09	0.06	0.16



The exposed cells along the cross section of a wood sample are far more likely to sorb higher amounts of preservative during treatment than the radial or tangential faces. Once in service, the end-grain is also more likely to lose preservative at a faster rate. Sampling the soil directly beneath selected posts for metal content revealed that copper, chromium and arsenic were all at slightly elevated levels immediately beneath the post and 300 mm below that zone, but were at background levels at the deepest sampling point (Table VI-6).

Table VI-6. Residual metal levels beneath the exposed end-grain of southern pine posts treated with 12 kg/m <sup>3</sup> of CCA and exposed for 47 years near Gainesville, Florida			
Depth Beneath Post (mm)	Residual Metal Level (ppm)		
	Copper	Chromium	Arsenic
0	18.3 (10.2)	0.60 (0.05)	1.09 (0.66)
300	5.5 (6.6)	0.41 (0.04)	2.41 (2.48)
1200	0.3 (0.1)	< 0.02	<0.05

Values represent means of 2 samples. Values in parentheses represent one standard deviation

The formulation used to treat these posts was similar to CCA Type B, which contains higher levels of arsenic than would be present in the currently used Type C formulation (Table VI-7). The higher arsenic levels and correspondingly lower chromium levels should result in less complete fixation and higher leaching losses. As a result, metal levels, particularly arsenic, should be higher in the soil than would be found with wood treated with CCA Type C.

Table VI-7. Relative proportions of copper, chromium, and arsenic in chromated copper arsenate (CCA) solutions (oxide basis). <sup>a</sup>			
CCA Type	Proportion in Solution (% oxide basis)		
	CuO	CrO <sub>3</sub>	As <sub>2</sub> O <sub>5</sub>
Type A	18.1	65.5	16.4
Type B	19.6	35.3	45.1
Type C	18.5	47.5	34

<sup>a</sup> Source: Standard P5 (American Wood Preservers' Association, 1999).

*Metal Levels Beneath CCA-Treated Southern pine stakes:* Although not the primary focus of the study, soil samples were also removed from beneath southern pine stakes treated with CCA to a retention of 23 to 24 kg/m<sup>3</sup> and exposed for 44 years at the Gainesville plot. Copper and chromium levels were elevated immediately beneath the stakes, but concentrations declined sharply 450 mm beneath the bottom of the stake and reached background levels within 900 mm (Table VI-8). Arsenic levels were within background levels at all of the sampling depths and were at the limit of detection 1350 mm below the stake. These results suggest that the metals can migrate, but the degree of downward movement from the treated stakes was minimal.

Table VI-8. Residual metal levels beneath four southern pine sapwood stakes treated with CCA to a retention of 23 to 24 kg/m <sup>3</sup> and exposed for 44 years near Gainesville, Florida.			
Depth Beneath Stake (mm)	Residual Metal levels (ppm)		
	Copper	Chromium	Arsenic
0	71.4 (56.0)	1.75 (0.44)	0.22 (0.10)
450	6.5 (7.5)	0.24 (0.19)	0.32 (0.28)
900	1.7 (2.6)	0.12 (0.07)	0.06 (0.02)
1350	0.1	<0.02	<0.05

---

---

## Literature Cited

- American Wood Preservers' Association. 1999a. Standard C1-99 All timber products— Preservative treatment by pressure processes. In: AWPB Book of Standards, Granbury, TX. Pages 23-32.
- American Wood Preservers' Association. 1999b. Standard P5-99 Standard for waterborne preservatives. AWPB Book of Standards, Granbury, TX. Pages 9-14.
- Anonymous. 1989. Methods of soil analysis used in the soil testing laboratory at Oregon State University. Publication SM 89:4, Agricultural Experiment Station, Oregon State University, Corvallis, Oregon. Pages 9-10.
- Conklin, S.W. 2001. Is Florida over-reacting: Modeling CCA treated wood. Proceedings American Wood Preservers' Association 97:109-114.
- Cooper, P.A. 1994. Leaching of CCA: Is it a problem. In: Environmental considerations in the manufacturer use and disposal of treated wood. Forest Products Society, Madison, Wisconsin. Pages 45-57.
- Cooper, P.A. D. Jeremic, J.L. Taylor, Y.T. Ung, and F. Kazi. 2001. Effect of humic acid on leaching of CCA from treated wood. Forest Products Journal 51(9):73-77.
- Cooper, P.A. and Y.T. Ung. 1997. Environmental Impact of CCA Poles in Service. International Research Group on Wood Preservation Document No. IRG/WP 97-50087. Stockholm, Sweden. 20pp
- Dahlgren, S.E. 1974. Kinetics and mechanisms of fixation of Cu-Cr-As wood preservatives. IV. Conversion reactions during storage. *Holzforschung* 28(2):58-61.
- Dahlgren, S.E. and W.H. Hartford. 1972a. Kinetics and mechanisms of fixation of Cu-Cr-As wood preservatives. III. Fixation of Tanalith C and comparison of different preservatives. *Holzforschung* 26(4):142-149.
- Dahlgren, S.E. and W.H. Hartford. 1972b. Kinetics and mechanisms of fixation of Cu-Cr-As wood preservatives. II. Fixation of Boliden K33. *Holzforschung* 26(3):105-113.
- Dahlgren, S.E. and W.H. Hartford. 1972c. Kinetics and mechanisms of fixation of Cu-Cr-As wood preservatives. I. pH behaviour and general aspects of fixation. *Holzforschung* 26(2):62-69.
- Gaviak, R.G., D.A. Horneck, and R.O. Miller. 1994. Plant, soil and water reference methods for the Western region. Western States Proficiency testing program soil and plant analytical methods Version 4.00. WREP 125. Pages 120-122.
- Hartford, W.H. 1973. Chemical and physical properties of wood preservatives and wood-preservative systems. In: Wood Deterioration and its Prevention by Preservative Treatments, Volume 2 (D.D. Nicholas, Ed.). Syracuse University Press, Syracuse, NY. Pages 1-120.
- Henry, W.T. and E.B. Jeroski. 1967. Relationship of arsenic concentration to the leachability of chromated copper arsenate formulations. Proceedings, American Wood Preservers' Association 63:187-192.

- Jin, L., K.J. Archer, and A.F.Preston. 1992. Depletion and biodeterioration studies with development wood preservative formulations. *Proceedings American Wood Preservers' Association* 96:108-122.
- Matus, R. 2001. Wood Worries: could your home make you sick? *The Gainesville Sun* 125(253):Pages 1, 8A-9A.
- Mortimer, W.P. 1991. The environmental persistence and migration of wood pole preservatives. Report for the Canadian Electrical Association, CEA, Montreal, Quebec, Canada..
- Muraka, I.P., R. Malecki, B. Taylor, B. Hensel, and J. Roewer. 1996. Release, migration and degradation of pentachlorophenol around in-service utility poles. *Proceedings American Wood Preservers' Association* 92:180-187.
- Nordstrom, D.K. 2002. Worldwide occurrences of arsenic in ground water. *Science* 296:2143-2146.
- Parris, G. 2000. Arsenic: biochemistry and risk assessment of a threshold carcinogen. *Proceedings American Wood Preservers' Association* 96:64-80Pizzi, A. 1982. The chemistry and kinetic behaviour of Cu-Cr-As wood preservatives. Part III Fixation of CCA to wood. *J. Polymer Science and Chemistry* 20:739-764.
- Solo-Gabriele, H., T. Townsend, J. Penha, T. Tolaymat, and V. Calitu. 1999. Disposal-end management of CCA treated wood. *Proceedings American Wood Preservers' Association* 95:65-74.
- Schultz, T.P., D.D. Nicholas, and D.E. Petry. 2002. Depletion of CCA-C from ground contact wood: Results from two field sites with significantly different soils. *Holzforschung* 56:125-129.
- Townsend, T., K. Shook, T. Tolaymat, J.K. Song, H. Solo-Gabriele, N. Hasein, and B. Khan. 2000. New lines of CCA treated wood research: in service and disposal issues. Report #00-12. Florida Center for Solid and Hazardous Waste Management, University of Florida, Gainesville, Florida.
- U.S. Department of Agriculture (USDA). 1980. The biologic and economic assessment of pentachlorophenol, inorganic arsenicals, and creosote, Volume I. Wood preservatives. USDA Technical Bulletin 1658-1. USDA, Washington, D.C. 435 pages.
- Wang, J.-H., D.D. Nicholas, L.S. Sites, and D.E. Petry. 1998. Effect of soil chemistry and physical properties on wood preservative leaching. International Research Group on Wood Preservation Document No. IRG/WP/50111. Stockholm, Sweden. 12 pages.

---

---

## Summary

---

The Cooperative undertook projects under six Objectives. The progress on each one will be summarized below along with recommendations.

Under Objective I, we continue to examine the performance of various chemicals for arresting internal decay of wood. Tests of MITC-FUME treated Douglas-fir pole sections indicate that the release of methylisothiocyanate (MITC) is very slow at lower temperatures. Based upon this parameter, utilities need to be aware that tubes in poles in cooler climates may retain chemical for longer periods. This delayed release should not negatively affect performance. Evaluations of Douglas-fir poles treated in the above ground regions with MITC prior to pole setting indicated that MITC levels remained protective 19 years after treatment. These results illustrate the value of above ground treatment in areas where the risk of decay is elevated.

Evaluation of fluoride/boron rods in Douglas-fir pole sections showed that the fluoride component remained well below protective levels over a 10 year period, while the boron levels were initially elevated then declined over time. Neither of the chemical's levels would be considered protective. In addition, increasing dosages (i.e. more rods per hole) appeared to result in reduced chemical loadings in the wood. We suspect this relates to moisture issues and are now investigating this phenomenon. For the present, it appears that increasing dosages do not result in markedly higher chemical levels over time.

Poles treated with a copper/boron paste as an internal treatment were evaluated after 15 years. Copper levels were below the protective threshold in the lower dosage (150 g per pole) but above that level in the higher dosage. Boron levels were just above the protective levels in the higher dosage treatment as well, suggesting that internal treatment with this paste could provide protection that was at least equivalent to the other water diffusible systems.

The ability of copper and boron to diffuse from copper boron rods was also assessed under Objective I. Copper migration from the rods was generally slight 2 years after treatment and probably did not contribute to the efficacy of this remedial treatment. Boron levels were above the protective threshold in several locations near groundline. The levels were similar to those found with rods containing only boron. The results suggest that the boron and copper/boron rods should produce similar performance over time.

Objective II addressed treatments for untreated wood exposed during installation- such as cuts or drilling for attachments. Tests of preservative coated galvanized rods suggest that boron, fluoride or copper move only a short distance from the rods 2 years after installation. The plastic coating applied to the rods to prevent damage to the preservative coating may have limited movement.

Evaluation of various topical treatments for protecting untreated exposed wood showed that water diffusibles provided protection for the longest period, particularly when applied in conjunction with an absorbent felt that acted as a preservative reservoir. Many oil borne preservatives lacked the ability to move and protect the wood. The results support previous work on field treated bolt holes and indicate that the most appropriate treatments for bolt holes and other untreated wood must have some water solubility so the preservatives can migrate into small checks as they open and close.

Objective III evaluates improved specifications of wood poles. We have begun to examine the effects of through-boring and radial drilling on pole properties. These investigations began after some storm related failures of through-bored poles suggested that the through-boring was the cause for failure. The analyses indicated that smaller hole sizes could affect strength to a greater extent than slightly larger holes because of a tendency for the smaller holes to concentrate stresses. Full scale testing will begin this winter to confirm the results of the modeling. The goal of this work is to move standards for through-boring and radial drilling through the American National Standards Institute standards.

An evaluation of Douglas-fir cross arms that had been in service for 45 to 60 years revealed that most of the arms retained sufficient strength, although they appeared to be badly weathered. A series of non-destructive tests were used in an attempt to predict material properties, but none appeared to be sufficiently reliable. Further tests are planned on additional crossarms with a goal of developing better tools for assessing wood condition.

Assessments were also made of various external barriers being marketed for protecting the groundline of poles from both moisture ingress and preservative loss. Moisture uptake was rapid in poles exposed without barriers while the barrier treatments tended to sharply reduce moisture changes. Exposing the butt of the poles while wrapping the sides resulted in an initially rapid moisture uptake in the butt, but the rate of moisture uptake slowed. The moisture conditions of these poles will continue to be monitored to assess the ability of these treatments to act as barriers.+

Objective IV addressed external groundline preservative systems. Field tests in New York show that chemicals continue to diffuse inward on penta treated southern pine poles. Older tests of a fluoride/boron bandage system indicate that the poles still contain protective levels of chemical 10 years after application. Further testing is planned to determine the thresholds of chemical required for each of these external preservative systems.

Objective V examines the performance of copper naphthenate treated wood in soil bed tests. Copper naphthenate continues to provide excellent protection to western redcedar sapwood after 172 months of exposure. Further evaluations of field exposed poles are planned for the coming year to ensure that this treatment continues to provide acceptable protection.

Objective VI examines the potential for migration of preservatives from treated wood. Studies of preservative migration from pentachlorophenol treated Douglas-fir poles revealed that some penta was always present in rainwater runoff from the poles. Penta concentrations were not affected by rainfall amounts or time between rainfall events, only total amount of rainfall. These results indicate that penta losses can be predicted allowing for pole storage management to minimize losses. Assessment of metal migration from chromated copper arsenate treated southern pine posts indicated that metal levels were elevated within 300 mm of the posts, but fell to background levels at distances further from the wood. The results suggest that CCA treated utility poles pose little risk to the surrounding environment in soil exposures. These results mirror similar tests on ACZA treated poles.

