

TABLE OF CONTENTS

CONSERVING ENERGY BY ENVIRONMENTALLY ACCEPTABLE PRACTICES IN MAINTAINING AND PROCURING TRANSMISSION POLES

Cooperators ..... i  
 Electric Utilities ..... i  
 Western Wood Preserver's Institute ..... i  
 Personnel ..... ii  
 Advisory Committee ..... ii  
 Research ..... ii  
 SUMMARY ..... iii

OBJECTIVE I

DEVELOP SAFER CHEMICALS FOR CONTROLLING INTERNAL DECAY OF WOOD POLES ..... 1

A. EVALUATE PREVIOUSLY ESTABLISHED TESTS OF VOLATILE REMEDIAL INTERNAL TREATMENTS ..... 1

*Dorena* 1. Treatment of through-bored Douglas-fir poles with gelatin encapsulated MITC or chloropicrin ..... 3  
*Alderwood* 2. Above ground treatment with gelatin encapsulated or pelletized MITC ..... 3  
*MITC-SunB* 3. Nine year performance of glass-encapsulated methylisothiocyanate ..... 3  
*93 W* 4. Treatment of Douglas-fir transmission poles with Basamid and copper ..... 6  
*Minion Co* 5. Evaluation of metham sodium for remedial treatment of large Douglas-fir timbers ..... 10  
*San Jose* 6. Distribution of MITC in Douglas-fir and Ponderosa pine poles 1 year after metham sodium treatment ..... 13  
*Voial Pole* 7. Effect of decay voids on fumigant movement and effectiveness in Douglas-fir poles ..... 16  
*Basamid* 8. Preliminary field trials to evaluate Basamid in Douglas-fir heartwood ..... 18

B. ABILITY OF WATER DIFFUSIBLE TREATMENTS TO ARREST AND PREVENT INTERNAL DECAY ..... 19

*Proeschon* 1. Evaluation of a boron/fluoride rod in Douglas-fir poles ..... 19  
*Impel* 2. Evaluation of fused boron rods in Douglas-fir poles ..... 19  
*Borax* 3. Evaluation of fused borate rods plus glycol for enhanced diffusion in Douglas-fir poles ..... 19  
*Flural* 4. Performance of sodium fluoride rods in Douglas-fir poles ..... 21  
*Curry 20* 5. Diffusion of copper and boron from a copper naphthenate/boron paste ..... 21  
 6. Development of threshold values for boron in Douglas-fir ..... 23

OBJECTIVE II

IDENTIFY CHEMICALS FOR PROTECTING EXPOSED WOOD SURFACES IN POLES ..... 28

*FD 10/10* A. EVALUATION OF TREATMENTS FOR PROTECTING FIELD-DRILLED BOLT HOLES ..... 28

- B. USE OF SMALL SCALE BIOASSAYS FOR EVALUATING PROTECTION OF FIELD DRILLED BOLT HOLES IN RED OAK, YELLOW POPLAR, LOBLOLLY PINE AND DOUGLAS-FIR . 31
- C. EVALUATION OF TOPICAL TREATMENTS FOR PROTECTING UNTREATED DOUGLAS-FIR TIMBERS ..... 39

*Simpers*

**OBJECTIVE III**

EVALUATE PROPERTIES AND DEVELOP IMPROVED SPECIFICATIONS FOR WOOD POLES ..... 45

- A. DEVELOP IMPROVED PATTERNS FOR THROUGH-BORING DOUGLAS-FIR POLES ... 45
- B. EVALUATE OF INSPECTION DEVICES FOR DETECTING AND ESTIMATING DECAY IN DOUGLAS-FIR POLES ..... 48
- C. A SURVEY OF UTILITY MAINTENANCE AND REMEDIAL TREATMENT PRACTICES .. 48
  - Utility Pole Inspection and Maintenance Practices ..... 50
- D. POLE DISPOSAL IN THE PACIFIC NORTHWEST ..... 57
  - Survey Methods ..... 58
  - Results ..... 58
  - Utility Pole Conference Survey of Handling and Disposal Practices of Northwest Utilities ..... 60
- E. EVALUATING THE LOAD CAPACITY OF GLULAM DAVIT ARMS AFTER TWENTY YEARS OF EXPOSURE ..... 65

*Thomson  
Pollock*

**OBJECTIVE IV**

PERFORMANCE OF EXTERNAL GROUNDLINE BANDAGES ..... 75

- A. EVALUATION OF SELECTED GROUNDLINE BANDAGES IN DOUGLAS-FIR, WESTERN REDCEDAR, AND PONDEROSA PINE, MERCED, CALIFORNIA ..... 75
  - B. EVALUATION OF SELECTED GROUNDLINE BANDAGES ON SOUTHERN PINE AND WESTERN REDCEDAR IN BINGHAMTON, NEW YORK ..... 79
  - C. PERFORMANCE OF COPPER AND PROPICONAZOLE BASED PASTES ON DOUGLAS-FIR POLE SECTIONS ..... 82
- Outcomes of This Objective ..... 82

*Merced  
Binghamton*

**OBJECTIVE V**

PERFORMANCE OF COPPER NAPHTHENATE-TREATED WESTERN WOOD SPECIES ..... 84

- A. DECAY RESISTANCE OF COPPER NAPHTHENATE-TREATED WESTERN REDCEDAR IN A FUNGUS CELLAR ..... 84
- B. EVALUATION OF COPPER NAPHTHENATE-TREATED DOUGLAS-FIR POLES IN SERVICE ..... 84

LITERATURE CITED ..... 95

## **COOPERATORS**

### **ELECTRIC UTILITIES**

- \* Bonneville Power Administration**
- \* Empire State Electric Energy Research Corporation**
- Central Hudson Power**
  - Con Ed**
  - Long Island Lighting Co.**
  - New York State Electric and Gas**
  - Niagara Mohawk**
  - Orange and Rockland Utilities Inc.**
  - Rochester Gas and Electric**
- \* Pacific Gas and Electric**
- \* Pacific Corp**
- \* Portland General Electric Company**

### **WESTERN WOOD PRESERVERS INSTITUTE**

**J.H. Baxter & Company**

**McFarland-Cascade Company**

### **CHEMICAL COMPANIES**

- \* CSI, Inc.**
- \* ISK Biotech**
- \* Osmose Wood Preserving, Inc.**

**\* Asterisk denotes funding. All supplied poles, hardware, or other assistance.**

**PERSONNEL**  
**ADVISORY COMMITTEE**

David Asgharian, Pacific Power  
Dennis Hayward, Western Wood Preservers' Institute  
Chris Damaniakes, Pacific Gas & Electric  
Maira Fry, Pacific Gas and Electric Co.  
Bob James, Portland General Electric Company  
Al Kenderes, New York State Electric & Gas Corp.  
W. McNamara, Osmose Wood Preserving, Inc.  
James Cahill, Bonneville Power Administration  
Mark Newbill, Bonneville Power Administration  
Alan Preston, CSI, Inc.  
Tom Woods, ISK Biotech

**RESEARCH**

Principle Investigator:

Jeffrey J. Morrell, Professor, Forest Products (Wood Preservation)

Research Associates:

Theodore C. Scheffer, Forest Products, (Forest Products Pathology) (Retired)  
Arlene Silva, Forest Products (Forest Products Pathology)

Visiting Scientists

Gyu Hyeok Kim, Korea University  
T. Narayanappa, Institute of Wood Science, Bangalore, India

Research Assistants:

Hua Chen, Forest Products  
Camille Freitag, Forest Products  
Connie Love, Forest Products  
Ron Rhatigan, Forest Products

Graduate Students:

Matthew Anderson, M.S. Forest Products  
Andrew Chang, M.S., Forest Products  
Engin Gezer, Ph.D., Forest Products  
Sung Mo Kang, M.S., Forest Products  
Wen Long He, M.S., Forest Products  
Mark Mankowski Ph.D., Forest Products  
Philip Schneider, Ph.D., Forest Products

Consultants:

Walter Thies, Forest Sciences Laboratory, U.S. Forest Service (Forest Pathologist)  
W.E. Eslin, U.S. Forest Products Laboratory (Forest Products Pathologist) (Retired)  
Wayne Wilcox, University of California (Forest Products Pathologist specializing in microscopy)

## SUMMARY

The Coop continues to address research under five objectives: internal remedial treatments, protecting field damage to treated wood products, improving the quality of new poles, assessing external preservative treatments, and assessing the performance of new preservatives for wood poles.

**Objective I.** Field trials of MITC-Fume, the glass encapsulated methylisothiocyanate (MITC) were sampled within the treatment zone 9 years after chemical application. The results indicate that MITC levels were low within the original treatment zone. Field trials of metham sodium in San Jose, CA continue to show that MITC levels remain elevated in the poles 2 years after treatment. The results are similar to those found at the Corvallis site and suggest that this chemical should perform similarly at both sites. Field trials of Basamid with and without copper continue to perform similarly to metham sodium. The results indicate that Basamid is an excellent alternative to liquid metham sodium and this chemical is in the final stages of registration for application to wood poles.

Diffusible internal preservatives continue to be monitored at the Corvallis test site. Fluoride levels in sodium fluoride rod treatments 2 years after application continue to be somewhat lower than expected. This pattern of slower diffusion into Douglas-fir is consistent with previous tests of fused borate rods. Field trials of fused borate rods were sampled, but the analyses were not completed in time for inclusion into this report. Analysis of samples removed from Douglas-fir poles internally treated with a copper naphthenate/boron diffusible paste showed that the boron had become well distributed around the original treatment site, while copper was less widely distributed reflecting a lower water solubility.

**Objective II.** Field trials of remedial treatments for protecting field cuts in treated wood are now in their 16th year and continue to show the benefits of using water diffusible boron or fluoride in place of oilborne pentachlorophenol. Results from a newly developed laboratory test are also report. This method was designed to reduce the time required to demonstrate efficacy. The preliminary trials with this chemical showed that copper-8-quinolinolate provided excellent protection against fungal attack, while penta provided slightly lower levels of protection. The latter finding was consistent with the field results. Field results of topical treatment performance on timbers and decks are also reported to provide additional supporting data on effectiveness of specific treatments.

**Objective III.** Analysis of through boring data is continuing. We have developed two expanded through boring patterns that take into account the ability to accept small skips in treatment as well as our better understanding of the distribution of preservative around individual through bored holes. These patterns would reduce the number of holes required for treatment, potential reducing mechanical effects as well as reducing pole costs.

Surveys of pole disposal practices in the Pacific Northwest suggest that pole replacement rate are relatively low and that most utilities spend little on disposing of poles. Most utilities gave poles to adjacent land owners, although a number also sold surplus poles. The results indicate that pole disposal, although an emotional issue, is not a practical concern for most utilities.

A survey of utility maintenance practices is nearing completion. A preliminary tabulation of the data suggests that most utilities are now experiencing high rates of either carpenter ant or woodpecker attack, although rates of attack at some utilities

was extremely high. The results of the full survey will be provided in the next annual report.

**Objective IV.** Field trials of external groundline preservative pastes continue to show that these formulations are performing well under a variety of environmental conditions. Field tests have also been established using a new copper/boron/fluoride paste and a propiconazole based system.

**Objective V.** Copper naphthenate treated western redcedar continues to perform well in fungus cellar tests, although samples that were weathered prior to treatment are providing lower degrees of protection than non-weathered samples. A survey of copper naphthenate treated Douglas-fir poles in Oregon and California found no evidence of surface decay or chemical depletion. The results indicate that copper naphthenate treated poles are performing well at both locations.

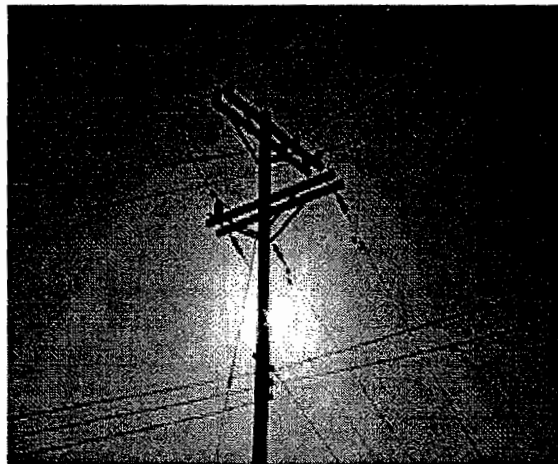

# OBJECTIVE I

## DEVELOP SAFER CHEMICALS FOR CONTROLLING INTERNAL DECAY OF WOOD POLES

Improvements in specification, treatment and inspection have combined to markedly enhance the performance of wood poles in North America. Despite these steps, however, a percentage of poles will eventually develop problems with decay or insect attack. In reality, this damage is no different than that which might occur with steel (which can corrode), concrete (which spalls), or any other material. Proper combinations of specification, treatment, and quality control reduce the risk of such damage occurring, regardless of material, but they cannot completely prevent damage. As a result, utilities must perform regular inspections of their poles to maintain system integrity and safety.

One of the advantages of wood for supporting overhead lines is the relative ease with which insect and fungal damage can be controlled. A wide array of treatments have been developed for remedially arresting decay and these systems have contributed, to a great measure, in the continued use of wood poles. Probably, the most important of the remedial treatments have been those designed to control internal decay of thin sapwood species. In these instances, checks through a well-treated shell of preservative permit the entry of moisture and fungal spores into the untreated wood within the pole. Eventually, decay fungi hollow out the pole near the groundline, leaving only the outer preservative treated shell to support the design load. The development of decay-arresting fumigants in the late 1960s provided one of the first widely effective methods for economically prolonging the service life of decayed poles. As a result, nearly 90% of utilities in North America use fumigants as part of their pole maintenance programs, saving over one billion dollars per year in replacement costs.

Despite their widespread use, fumigants pose a challenge to users. Two of the three formulations registered with the U.S. Environmental Protection Agency for wood

application are liquids (**Table I-1**), that can be spilled during application. One of these liquids, chloropicrin, is highly volatile and applicators must wear respirators when applying this chemical. In these times of heightened environmental sensitivity, the image of workers applying chemicals to poles while wearing respirators is difficult to explain to customers. The other liquid fumigant, metham sodium (32.7% sodium n-methyl-dithiocarbamate) is caustic. The third fumigant registered for wood use (methylisothiocyanate) is a solid at room temperature, but it too is caustic and must be contained in either aluminum or glass capsules prior to application. Despite their widespread effectiveness, the drawbacks associated with each of these chemicals has encouraged a search for safer internal remedial treatments. In Objective I, we will present data on the currently registered fumigants along with information of formulations currently under evaluation. In addition, we will present information on the performance of various water-diffusible remedial treatments.

### A. EVALUATE PREVIOUSLY ESTABLISHED TESTS OF VOLATILE REMEDIAL INTERNAL TREATMENTS

Over the past 20 years, a variety of field trials have been established to evaluate the efficacy of various remedial treatments (**Table I-2**). Many of these trials lasted only a few years, but several have been maintained for longer periods to develop data on long term performance of the more commercially important remedial treatments. Such data can be invaluable when making decisions concerning the effectiveness of the various treatments. In this section, we describe results from those trials involving volatile chemicals.

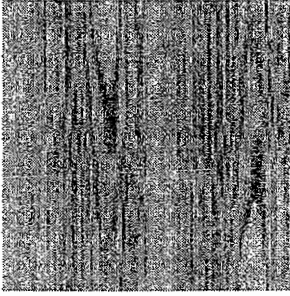

Table I-1. Characteristics of internal remedial treatments for wood poles.

Trade Name	Active Ingredient	Concentration %	Toxicity (LD <sub>50</sub> )	Manufacturer
Timber Fume	Trichloronitromethane (Chloropicrin)	96	205 mg/kg	Osmose Wood Preserving Great Lakes Chemical Co.
Wood Fume	Sodium n-methyldithiocarbamate	32.1	1700-1800 mg/kg	Osmose Wood Preserving
ISK	Sodium n-methyldithiocarbamate			ISK Biotech Inc.
Vorlex	20% methylisothiocyanate 80% chlorinated C <sub>3</sub> hydrocarbons	20%	538 mg/kg	NorAm Chemical Co.
MITC-FUME	methylisothiocyanate	96	305 mg/kg	Osmose Wood Preserving
Impel Rods	boron	99		CSI Inc.
Pole Saver	sodium octaborate tetrahydrate/ sodium fluoride	58.2/24.3		Preschem Ltd.
Flurods	sodium fluoride			Osmose Wood Preserving



Table I-2. Active field trials evaluating the performance of selected internal remedial treatments.

Test Site	Chemicals Evaluated	Date Installed	1997-98 Activity
Peavy Arboretum	Field drilled bolt hole treatments	1981	Yes
<del>Peavy Arboretum</del>	<del>Cedar pole sprays</del>	<del>1981</del>	<del>None</del>
Dorena Tap (BPA)	Encapsulated MITC and Chloropicrin	1982	No
Coos Bay, Oregon	Encapsulated MITC	1985	No
Alderwood Tap (BPA)	Pelletized and encapsulated MITC	1984	No
Peavy Arboretum	Encapsulated MITC (MITC-Fume)	1988	Inspected
Peavy Arboretum	Copper naphthenate/boron	1989	Inspected
Peavy Arboretum	Impel Rods	1993	Inspected
Hilo, Hawaii (CSI)	Impel Rods	1990	None
Central Lincoln (CLPUD)	Encapsulated MITC	1986	None
Pacific Power, Corvallis	Basamid	1993	Inspected
Peavy Arboretum	Boron/Fluoride Rods	1993	No
Peavy Arboretum	Sodium Fluoride Rods	1995	Inspected
San Jose, CA	Metham-sodium	1996	Inspected

**1. Treatment of through-bored Douglas-fir poles with gelatin encapsulated MITC or chloropicrin:**

The Douglas-fir poles treated with gelatin encapsulated chloropicrin or MITC in 1982 were last inspected in 1996.

**2. Above ground treatment with gelatin encapsulated or pelletized MITC:**

The trial evaluating gelatin encapsulated and pelletized MITC in above-ground applications was last evaluated in 1996 and was not sampled this year.

**3. Nine year performance of glass-encapsulated methylisothiocyanate:**

The control of internal decay in wood products with volatile chemicals (fumigants) continues to represent a simple,

economical method for extending the useful life of wood. For many years, the chemicals used for fumigant treatment were all liquids with varying degrees of volatility. This risk of spills and concerns about handling safety encouraged research to develop less volatile fumigants. Among the first chemicals identified for this purpose was methylisothiocyanate (MITC), a chemical which is solid at room temperature, but sublimates directly to a gas. MITC is the primary decomposition product of metham sodium, the most commonly used fumigant for wood applications. Its availability in a highly pure (96% active ingredient) solid form made it highly attractive for wood pole applications (Morrell and Corden, 1986), but the caustic nature of MITC made it difficult to handle. Preliminary trials suggested that gelating capsules could be used

to contain MITC prior to application (Zahora and Corden, 1985), but the process was never commercialized because of the cost of gelatin. Field trials, however, indicated that this encapsulation process provided excellent control against spills with no adverse effects on chemical performance.

Subsequently, MITC was encapsulated in borosilicate glass tubes plugged with Teflon caps for commercial application. Field trials were established to evaluate the effect of glass encapsulation on the rate of MITC release, residual MITC in the wood, and the ability of these MITC concentrations to inhibit decay fungi. Results of these trials were reported 3 years after test initiation (Morrell et al., 1992). This section describes the results of continued monitoring of these trials.

The methods follow those described previously (Morrell et al., 1992). Briefly, two series of tests were established.

**Small Scale Trials:** <sup>Eighteen</sup> ~~Eight~~ 25 cm diameter by 75 cm long Douglas-fir (*Pseudotsuga menziesii* (Mirb) Franco) pole sections were end-coated with elastomeric paint. One half of these sections was air seasoned to a moisture content below 25%; others were used while the wood remained above the fiber saturation point. A single 19 mm diameter by 205 mm long hole was drilled at a 45 degree angle near the center of the pole and a single MITC-Fume tube (ampule) containing 30 g of MITC was inserted, open side downward. The holes were plugged with rubber stoppers. Sets of three pole sections per moisture content were stored at 5°C (cold room), outdoors at ambient temperature (outdoors), or at 32°C and 90% relative humidity (hot wet room). At periodic intervals, the plugs were removed and the ampules were weighed to assess chemical loss over time.

**Field Trials:** Equal numbers of Douglas-fir (*Pseudotsuga menziesii* (Mirb.) Franco) and southern pine (*Pinus taeda* L) pole sections (25 to 30 cm in diameter by 3.6 m long) were pressure treated with chromated copper arsenate to a retention of 6.4 kg/m<sup>3</sup>, then painted with an elastomeric paint to retard fumigant loss. The

poles were set to a depth of 0.9 m at a site located near Corvallis, Oregon. A series of 2, 4, 6, or 8 holes, 1.9 cm in diameter by 205 mm long were drilled in each group of six poles. Each hole received a MITC-Fume vial inserted with the open end downward and was plugged with a tight fitting preservative treated dowel. An additional set of five poles per species was treated with 500 ml of metham sodium equally distributed among three holes drilled as described for the MITC fume. A final set of five poles received no chemical treatment.

The ability of MITC to diffuse through the wood was analyzed using combinations of bio- and chemical assays. Over the entire study, the poles were assessed using closed tube bioassays, culturing of increment cores for fungi, and extraction for chemical analysis of residual MITC.

The poles were sampled 1, 2, 3, 5, 7, and 10 years after installation by removing two 150 mm long increment cores, 180 degrees apart, from each test pole 0.3 m below groundline, and 3 increment cores 120 degrees apart from site 0, 0.3, 0.9, and 1.5 m above the highest treatment hole. The inner and outer 25 mm of each core were placed in separate tubes containing actively growing cultures of *Postia placenta* on malt agar slants. The tubes were capped and incubated in an inverted position so that the fungus was above the wood sample resting inside the cap. Radial growth of the fungus was measured after 2 to 3 weeks and this growth rate was compared to that of similar tubes without wood to provide a measure of the ability of the fumigant treated wood to inhibit decay fungi. This method has high sensitivity to MITC (Zahora and Morrell, 1988).

The middle section from each closed tube sample was placed on malt agar in a petri dish and observed over a 1 month period for evidence of fungal growth. Any fungi growing from the wood were examined for characteristics typical of basidiomycetes, a group of fungi containing many important wood decayers. The presence of non-basidiomycetes was also noted.

The inner and outer 25 mm sections of a second core from each site were placed into 5 ml of ethyl acetate and extracted for 48 hours prior to analysis. Chemical analysis was performed in a manner similar to that described previously.

In addition to the normal sampling, we investigated the residual MITC levels in the treatment zone 9 years after treatment. Increment cores were removed at two locations— at the very center of the treated zone and at groundline. As in the normal samples, the outer treated zone was removed and the inner and outer 25 cm of the remaining core were extracted in ethyl acetate and analyzed using the GC.

MITC release rates from the glass ampules in pole sections stored under varying conditions continued to show that temperature had a marked effect on the length of time that the chemical remained in the ampule. Ampules from poles stored under hot wet conditions exhibited chemical loss within 1 year after treatment, while those stored at 5°C continue to retain nearly one-third of the original chemical (**Figure I-1**). Ampules in poles which were originally treated while green and then stored outdoors, continue to retain small amounts of chemical, while no MITC remains in vials from poles treated dry and stored in the same manner. The effect of moisture content on release was perplexing since one would expect that any moisture variations would equilibrate over time. One might expect that MITC sorption would be affected by higher MCs (Zahora and Morrell, 1989), but this effect should disappear as the log sections equilibrated to their ambient moisture levels. The difference between wet and dry treated pole sections has continued over the 9 year test period. A smaller, but similar trend was noted with the pole sections stored at 5°C.

In the field test, MITC levels ~~at the top of the treatment zone~~ were uniformly low in both Douglas-fir and southern pine poles 9 years after MITC-Fume or metham sodium treatment regardless of dosage (**Figure I-2**). These results

were consistent with those found after 7 years and suggested that the MITC had largely moved from the poles. Analyses of cores removed from the middle of the treatment zone of these same poles, however, continued to show evidence of MITC 9 years after treatment (**Figure I-3**). As expected, MITC levels were generally higher in the inner zone of the poles, reflecting a tendency for many fumigants to move both downward and inward from the point of application. MITC levels in the treatment zone were especially elevated in the southern pine poles, a surprising finding given previous studies showing that fumigants are far less effective on this species group. The levels of MITC differed little in Douglas-fir poles, suggesting that the remaining chemical represents the material that is physically sorbed to the wood. This chemical should be available if the wood becomes wet and provides a reservoir of protection against fungal attack. The MITC levels in southern pine poles increased with dosage (except for the 180 g treatment). In addition, MITC levels in the metham sodium treatments remained elevated in the inner zone of the southern pine poles. The results suggest that MITC should provide better protection in interior of southern pine poles.

The poles will be completely sampled this year (10 years) to provide final results. At present, the analyses suggest that MITC remains detectable in the zone where the ampules was originally applied, but has largely diffused from the poles above this zone. Chemical levels within the treatment zone remain adequate in the pine poles, but have declined to the point where retreatment would be advisable in the Douglas-fir poles.

GL

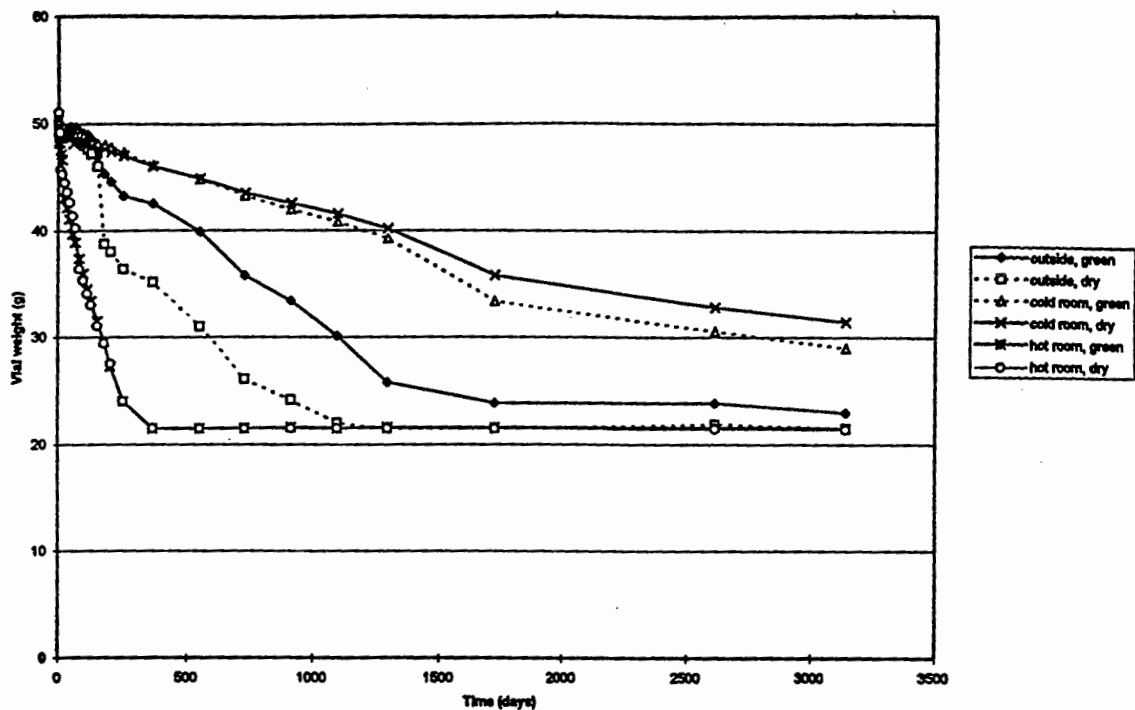

Figure I-1. Rate of MITC loss from MITC-Fume ampules placed in green or air-dried Douglas-fir poles and stored at 5 C, 32 C or left outside for 9 years in Corvallis, Oregon.

**4. Treatment of Douglas-fir transmission poles with Basamid and copper:** The field trial of solid Basamid with and without copper sulfate is now in its fourth year. Briefly, three steeply sloped 19 mm diameter by 375 mm long holes were drilled into pentachlorophenol-treated Douglas-fir poles beginning at groundline and moving upward at 150 mm intervals and 120 degrees around the pole. The poles received 200 or 400 g of Basamid with or without 1% copper sulfate. An additional set of poles received 500 g of metham sodium (32.7% sodium n-methylthiocarbamate). Each treatment was replicated on five poles.

The poles have been sampled annually by removing increment cores from 3 sites around the pole, 0, 1, 2, and 3 m above the highest treatment hole (0.3, 1.3, 2.3, and 3.3 m above groundline). The outer, treated shell was discarded, then the outer and inner 25 mm of the remaining core were placed into tubes containing 5 ml of ethyl acetate. The tubes were stored for 48 hours at room temperature before the ethyl acetate was analyzed for MITC by gas chromatography. The remainder of each core was placed on malt extract agar in petri dishes

and observed for fungi growth from the wood. Any fungi growing from the wood were examined microscopically for characteristics typical of Basidiomycetes, a group of fungi containing many important wood decayers. Culturing indicated that none of the test poles contained viable decay fungi (Tables I-3).

MITC was detectable in most treatments at all four sampling heights, but for practical purposes, protective levels were only found 0.3 and 1.3 m above the groundline (Tables I-4). MITC levels at these two sampling locations dropped sharply in most treatments between 3 and 4 years after treatment (Figures I-4). The reasons for the sharp declines are unclear. This rainfall levels during the fourth year were exceptionally high, suggesting that wood moisture contents should also have been somewhat higher than normal. Since moisture is essential for both metham sodium and Basamid decomposition to MITC, we might have expected elevated levels of chemical in the poles; however, this event did not occur. Chemical levels 0.3 m above the groundline still remain elevated in many treatments, suggesting that decomposition is still

### MITC Levels in Douglas-fir at Groundline

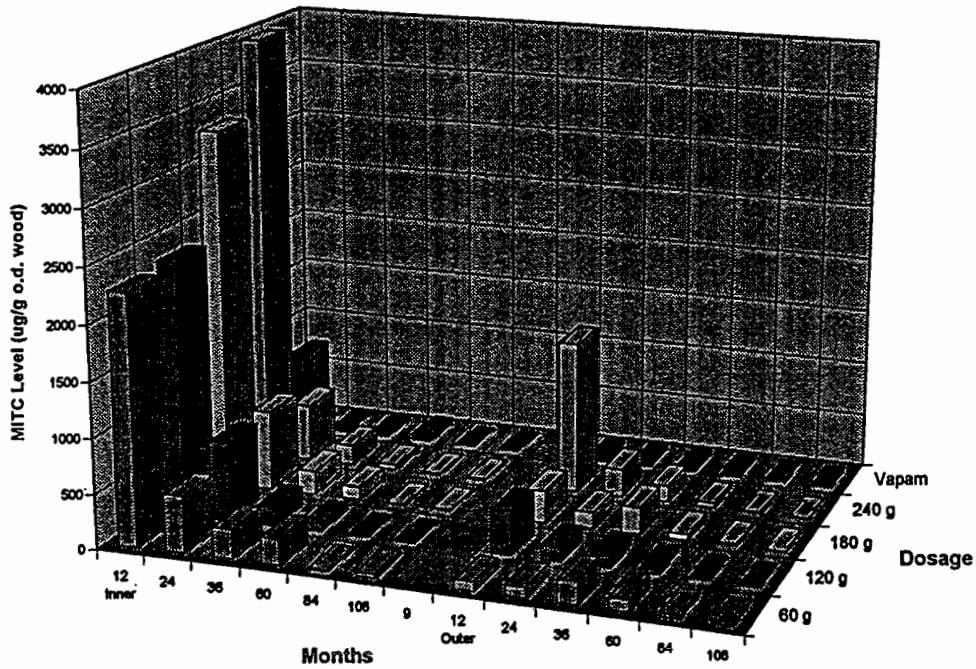

### MITC Levels in Southern Pine at Groundline

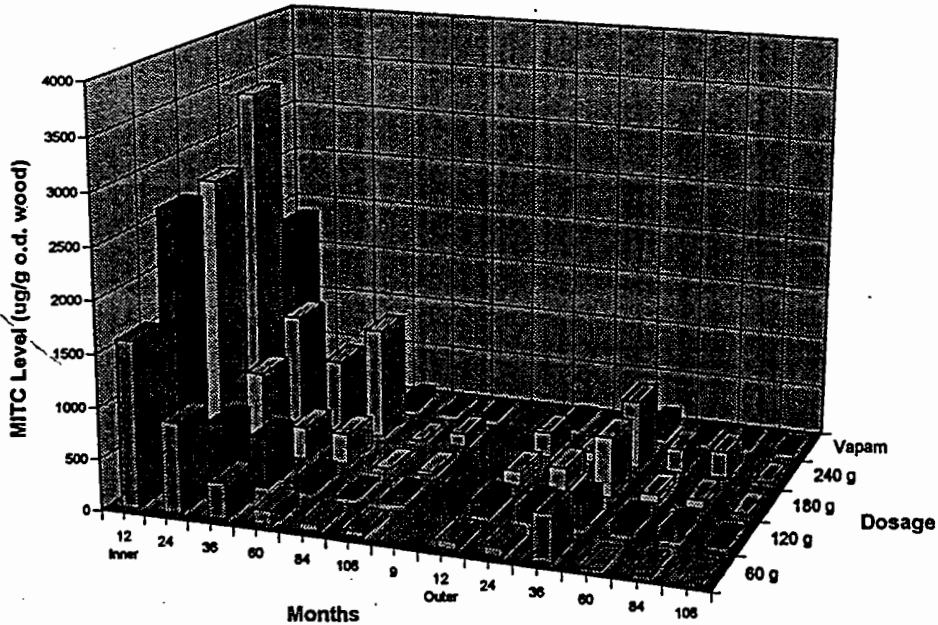

Figure I-2. Residual MITC in increment cores removed from the inner and outer 25 mm of increment cores removed from top of the treatment zone a) Douglas-fir and b) southern pine poles 1 to 9 years after application of 60 to 240 g of MITC-Fume.

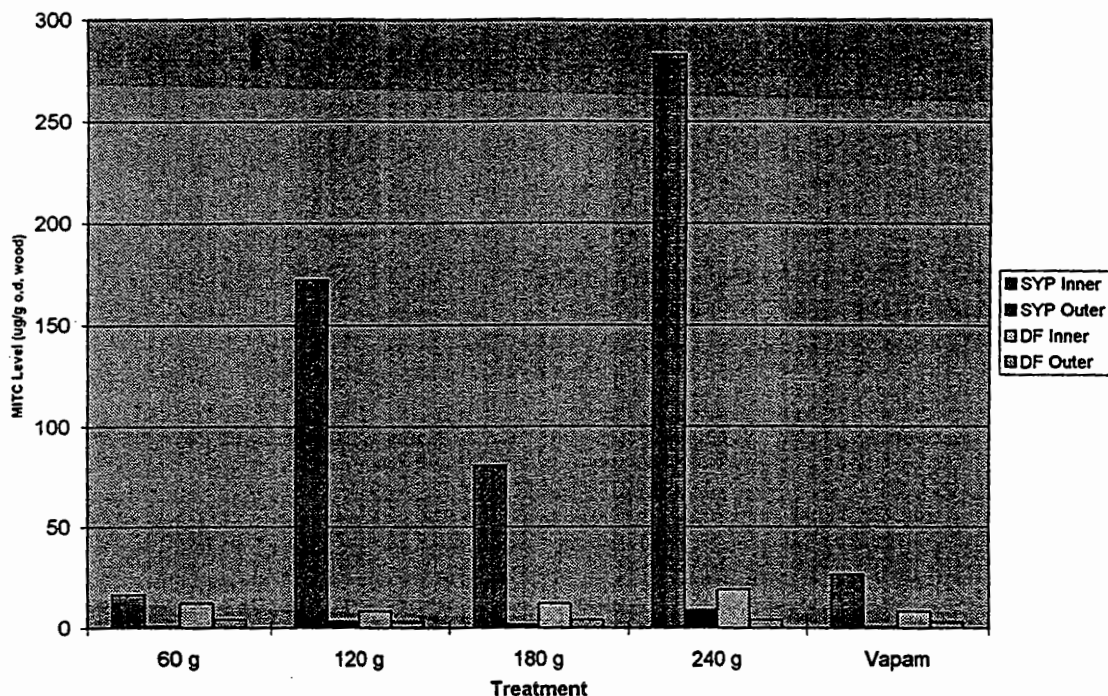

Figure 1-3. Residual MITC in increment cores removed from the inner and outer 25 mm of increment cores from the treatment zone of Douglas-fir and southern pine poles 9 years after application of 60 to 240 g of MITC-Fume.

Table I-3. Isolation frequencies of decay and non-decay fungi in increment cores removed from Douglas-fir transmission poles 1 to 4 years after treatment with Basamid or metham sodium.

Treatment	Dose	Copper Sulfate Added	Isolation Frequency% <sup>a</sup> <i>above GL</i>												
			Distance from Treatment Hole (m)												
			0.3m				1.3m			2.3m			3.3m		
			0 yr	2 yr	3 yr	4 yr	2 yr	3 yr	4 yr	2 yr	3 yr	4 yr	2 yr	3 yr	4 yr
Vapam	500 ml		3 <sup>23</sup>	0 <sup>10</sup>	0 <sup>10</sup>	0 <sup>7</sup>	0 <sup>23</sup>	0 <sup>7</sup>	0 <sup>10</sup>	0 <sup>17</sup>	0 <sup>3</sup>	0 <sup>23</sup>	0 <sup>10</sup>	0 <sup>3</sup>	0 <sup>13</sup>
Basamid	400g		0 <sup>33</sup>	0 <sup>14</sup>	0 <sup>10</sup>	0 <sup>0</sup>	0 <sup>14</sup>	0 <sup>8</sup>	0 <sup>0</sup>	0 <sup>13</sup>	0 <sup>0</sup>	0 <sup>0</sup>	0 <sup>7</sup>	0 <sup>7</sup>	0 <sup>7</sup>
Basamid	400g	+	0 <sup>25</sup>	0 <sup>14</sup>	0 <sup>0</sup>	0 <sup>13</sup>	0 <sup>7</sup>	0 <sup>0</sup>	0 <sup>7</sup>	0 <sup>12</sup>	0 <sup>7</sup>	0 <sup>0</sup>	0 <sup>17</sup>	0 <sup>8</sup>	0 <sup>7</sup>
Basamid	200g		0 <sup>0</sup>	0 <sup>7</sup>	0 <sup>0</sup>	0 <sup>7</sup>	13 <sup>13</sup>	0 <sup>13</sup>	0 <sup>0</sup>	0 <sup>13</sup>	0 <sup>13</sup>	7 <sup>27</sup>	0 <sup>13</sup>	0 <sup>13</sup>	7 <sup>20</sup>
Basamid	200g	+	0 <sup>21</sup>	0 <sup>7</sup>	0 <sup>0</sup>	0 <sup>0</sup>	0 <sup>27</sup>	0 <sup>8</sup>	0 <sup>0</sup>	0 <sup>13</sup>	0 <sup>25</sup>	0 <sup>13</sup>	0 <sup>13</sup>	0 <sup>18</sup>	7 <sup>7</sup>

a) Initial samples were shavings from the treatment hole. Values represent 15 samples/treatment for Basamid and 30 for metham sodium. Superscripts represent percentage of nondecay fungi.

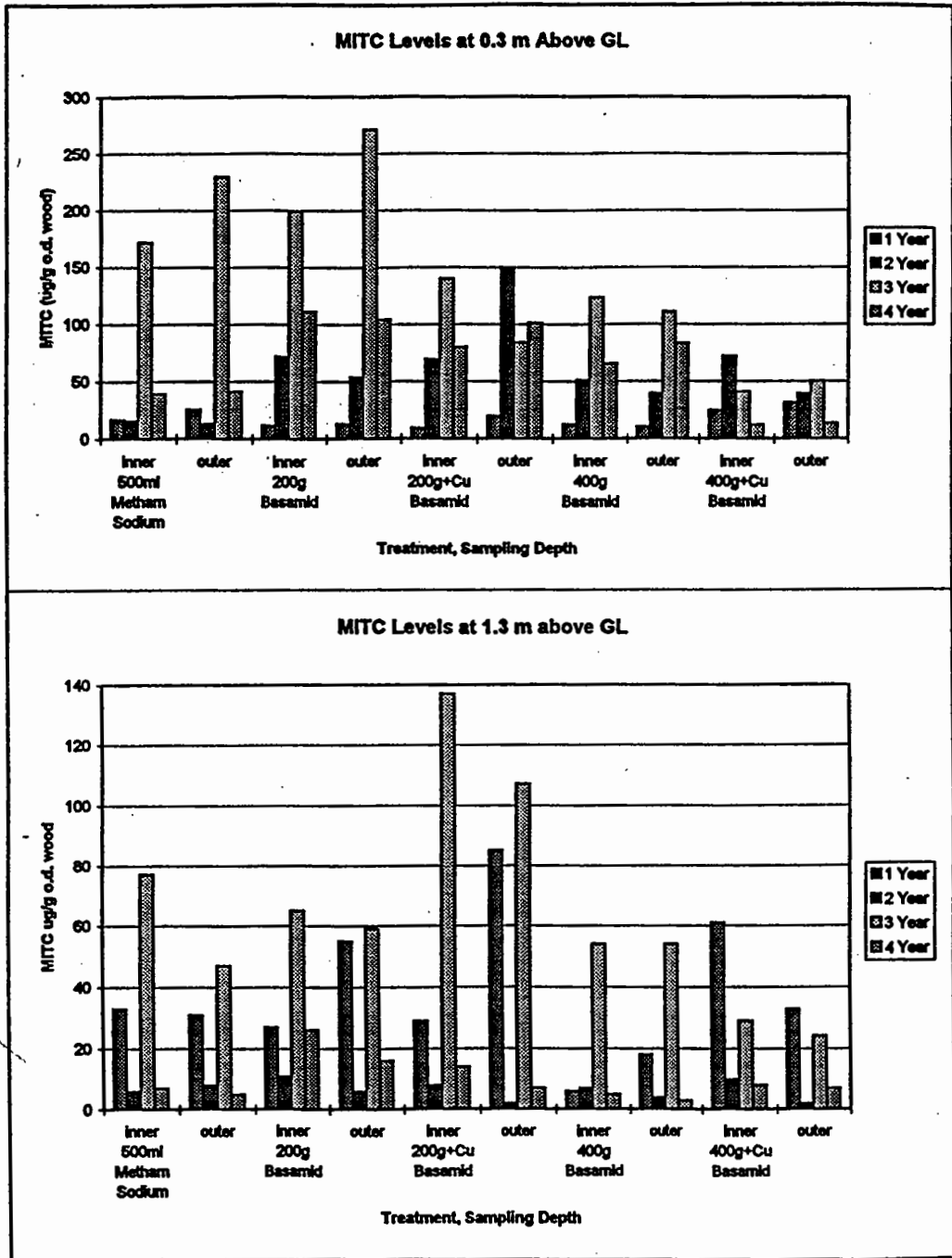

Figure I-4. Residual MITC 0.3 or 1.3 m above the groundline in Douglas-fir poles 1 to 4 years after treatment with 200 or 400 mg of with or without copper in comparison to poles treated with 500 ml of metham sodium.

Table I-4. Residual MITC in Douglas-fir poles 1 to 4 years after treatment with Basamid or metham sodium.

Chemical	Copper Sulfate Added	Dosage	Year	Residual MITC (ug/g oven-dried wood)							
				Distance Above Groundline							
				0.3 m		1.3 m		2.3 m		3.3 m	
				inner	outer	inner	outer	inner	outer	inner	outer
Metham Sodium	-	500ml	1	16	25	33	31	0	1	1	0
	-	500ml	2	16	13	6	8	9	3	4	4
	-	500ml	3	172	229	77	47	10	6	2	1
	-	500ml	4	39	41	7	5	1	0	0	0
Basamid	-	200g	1	11	13	27	55	0	0	0	1
	-	200g	2	72	54	11	6	2	1	4	8
	-	200g	3	199	272	65	59	12	10	2	1
	-	200g	4	111	104	26	16	1	0	0	0
Basamid	+	200g	1	9	19	29	85	1	0	0	0
	+	200g	2	69	150	8	2	2	2	3	6
	+	200g	3	139	84	137	107	17	7	2	2
	+	200g	4	80	101	14	7	0	0	0	0
Basamid	-	400g	1	12	10	6	18	0	0	1	0
	-	400g	2	51	39	7	4	4	3	5	3
	-	400g	3	123	111	54	54	6	5	0	0
	-	400g	4	65	83	5	3	0	0	0	0
Basamid	+	400g	1	24	31	61	33	1	0	0	0
	+	400g	2	72	39	10	2	5	2	2	3
	+	400g	3	41	50	29	24	15	6	13	5
	+	400g	4	12	13	8	7	1	1	0	0

occurring. In addition, MITC levels continue to differ little between the 200 and 400 g dosages or between the copper and non-copper treatments. The lack of a dosage-response effect remains the most perplexing finding in these tests and indicates that more chemical does not necessarily translate to better control in pole treatments. Further sampling will be performed to determine if the higher dosages have any advantages over longer treatment cycles.

**5. Evaluation of metham sodium for remedial treatment of large Douglas-fir timbers:** While a majority of our studies have evaluated the efficacy of fumigants on poles and piling, these chemicals are also used on sawn members and may find some use for high value, larger dimension cross arms or braces. The characteristics of sawn members and poles vary in that sawn members expose slightly more surface area than a pole per unit volume. In addition, the process of sawing exposes and ruptures large numbers of cells on the wood surface. These cells can act as pathways for more rapid fumigant loss from the interior of the wood.



In order to better understand the behavior of fumigants in sawn-creosoted timbers, a study was initiated in 1990 in which a Douglas-fir highway bridge located near Salem, Oregon was treated with metham sodium. Metham sodium was applied through 19 mm diameter holes drilled at 1.2 m intervals along the length of the timbers. Residual chemical levels in the timbers have been assessed 1, 3, 6, and 7 years after treatment by removing increment cores from sites near the top and bottom edge, 0.6 m from the original treatment holes on each of 8 stringers. The outer, treated segment of each increment core was discarded and the inner and outer 25 mm of the remaining core were individually placed into test tubes containing 5 ml of ethyl acetate. The cores were extracted in ethyl acetate for a minimum of 48 hours at room temperature, then the extract was analyzed for residual MITC by gas chromatography. The remainder of each core segment was placed on malt extract agar in petri dishes and observed for growth of decay fungi which served as a measure of chemical effectiveness.

No decay fungi were isolated from increment cores removed from the metham sodium treated timbers 6 or 7 years after treatment (Table I-5). In addition, levels of non-decay fungi have remained relatively low for the past two years.

These results suggest that metham sodium continues to provide protection to the timbers.

MITC levels in the timbers continue to remain steady 7 years after treatment, although they declined slightly over the past year (Table I-6). Chemical levels appear to differ little between the inner and outer assay zones or between the tops and bottoms of each timber. These results indicate that MITC has become relatively well-distributed throughout the timbers and remains at protective levels.

This test was initiated to determine if fumigant performance would be similar between sawn timbers and poles. Fumigants might be expected to move out of sawn timbers more rapidly because of the surface to volume ratio, but the results after 7 years indicate that metham sodium is performing comparably in timbers. While these results were developed for bridges, they easily translate to larger cross arms and indicate that fumigant treatment of these larger members may be suitable for prolonging service life.



Table I-5. Isolation frequency of decay fungi and non-decay fungi from Douglas-fir bridge timbers prior to and 1 to 7 years after treatment with metham sodium.

Structure	Percent of Cores with Fungi					
	0 Year	1 year	2 years	3 years	6 years	7 years
5	- (-)	0 (42)	0 (90)	0 (22)	0 (0)	0 (0)
10	0 (17)	0 (42)	0 (58)	0 (50)	0 (0)	0 (8)
15	0 (17)	0 (0)	0 (100)	8 (67)	0 (0)	0 (0)
20	- (-)	0 (0)	0 (100)	0 (83)	0 (8)	0 (8)
25	0 (29)	0 (0)	0 (100)	8 (58)	0 (0)	0 (17)
30	29 (43)	0 (0)	0 (100)	0 (0)	0 (8)	0 (0)
35	13 (87)	0 (0)	0 (17)	8 (33)	0 (27)	0 (0)
40	0 (17)	- (-)	8 (42)	- (-)	- (-)	0 (0)

Values represent percent of cores containing decay fungi. Numbers in parentheses represent percent of non-decay fungi present in same cores.

Table I-6. Residual MITC in Douglas-fir bridge timbers 1 to 7 years after treatment with metham sodium.

Structure #	Stringer Position	MITC Content (ug/g o.d. wood)									
		Inner					Outer				
		1 yr	2 yrs	3 yrs	6 yrs	7 yrs	1 yr	2 yrs	3 yrs	6 yrs	7 yrs
5	Top	4.3	52.3	9.7	40.2	1.3	0.0	27.6	3.3	50.4	4.4
	Bottom	59.7	34.7	31.1	39.9	28.5	24.5	112.4	84.1	108.3	126.6
10	Top	40.2	136.1	71.3	46.9	21.3	53.2	60.3	76.4	42.6	42.1
	Bottom	75.8	114.9	43.0	60.0	42.0	39.9	59.4	116.3	58.4	15.0
15	Top	27.3	66.1	46.4	64.1	53.7	37.4	59.5	145.4	65.6	42.9
	Bottom	16.0	99.7	17.8	37.7	32.3	24.3	112.9	43.4	54.8	29.7
20	Top	26.2	114.9	58.2	32.0	20.9	65.4	130.6	44.6	66.1	34.9
	Bottom	82.7	42.6	67.7	57.1	74.5	23.2	19.9	163.1	51.9	72.4
25	Top	26.5	62.6	40.7	16.0	19.5	13.1	44.4	52.5	28.7	26.5
	Bottom	33.4	83.3	86.0	59.3	54.3	65.5	95.4	32.1	51.9	51.5
30	Top	73.2	126.8	77.5	40.5	49.7	100.3	98.5	70.2	37.2	35.7
	Bottom	83.6	40.8	83.3	28.2	35.0	75.8	63.7	49.3	40.0	24.1
35	Top	44.1	74.1	108.7	30.5	64.4	60.6	120.8	56.5	59.0	78.4
	Bottom	14.0	75.1	19.2	35.6	27.6	9.2	42.4	8.8	36.6	14.8
40	Top	-	50.1	-	-	16.8	-	140.4	-	-	49.7
	Bottom	-	92.1	-	-	18.0	-	56.7	-	-	7.5
Average	Top	34.5	87.7	58.9	38.6	31.0	47.1	85.3	64.1	50.1	39.3
	Bottom	52.3	72.9	49.7	45.4	39.0	37.5	70.4	71.0	57.4	42.7

Values represent means of 6 replicates. Inner and outer zones represent the 25mm one each end of an increment core sample.

#### **6. Distribution of MITC in Douglas-fir and Ponderosa pine poles 2 years after metham sodium treatment:**

While we have developed a reasonable understanding of the performance of metham sodium in Douglas-fir poles in the Pacific Northwest, the effects of climate and other variables on the performance of this chemical remain less well documented. Yet, metham sodium remains the most commonly used fumigant for controlling internal decay and this trend is likely to continue. In order to develop a better understanding of metham sodium performance under conditions other than those in Oregon, we established a field test in the Pacific Gas and Electric System in San Jose, California. Pentachlorophenol-treated Douglas-fir and ponderosa pine distribution poles were inspected by a commercial crew for the presence of decay and other defects. The poles were installed between 1952 and 1963, with the majority of poles being set between 1961 and 1963. Pole circumferences ranged from 725 to 975 mm (Class 4 to 6, 10.5 to 12 m long). Three steep angled holes were then drilled beginning slightly below groundline and moving upward at approximately 300 mm intervals and around the pole 120 degrees.

Shaving from the drill were collected and placed in bags. They were returned to the laboratory where they were briefly flamed and placed on malt extract agar in petri dishes. These segments were observed for evidence of fungal growth as described earlier.

The poles were then treated by adding 500 ml of metham sodium, equally distributed among the three drill holes which were plugged with tight fitting dowels. Five ponderosa pine and 11 Douglas-fir poles were treated in this manner.

One year after treatment, a series of increment cores were removed from sites located 0.3, 0.6, and 1.3 m above the groundline. Two cores were removed 0.3 m above groundline and 120 degrees around, from the highest treatment. Three cores were removed from sites 120 degrees apart at the other two sampling heights, with one core at each height being removed from directly above the highest treatment hole. Three poles located in backyards

were inaccessible for sampling. The outer and inner 25 mm of each core was placed into tightly capped vials and shipped to Corvallis, Oregon for later analysis. Five ml of ethyl acetate was then added to the vials and the samples were extracted for 48 hr prior to analysis. The remainder of the core was placed in a plastic drinking straw and stored on ice for later processing. The latter core segments were briefly flamed to kill any fungi on the wood.

The ethyl acetate extracts were analyzed for residual methylisothiocyanate content using a Varian 3700 Gas Chromatograph equipped with a flame photometric detector specific for sulfur residues as previously described (Zahora and Morrell, 1989). MITC levels were quantified by comparisons with prepared standards. The cores were then oven dried overnight and weighed (nearest 0.01 g). MITC content was then expressed on a ug/wood weight basis.

Fungal colonization in both Douglas-fir and ponderosa pine poles continues to be low (**Table I-7**). No decay fungi were isolated from either species prior to treatment, but the poles contained high levels of non-decay fungi that can serve as indicators of fumigant effectiveness. No fungi were isolated from cores removed from the groundline zone 1 year after treatment in either Douglas-fir or ponderosa pine poles, while limited numbers of fungi were isolated away from this zone at that time. Isolation levels increased near the groundline in Douglas-fir poles 2 years after treatment as well as 0.6 and 1.3 m above the groundline in the pine poles, but remained unchanged at the groundline in the pine. The results indicate that the metham sodium initially eliminates fungi from the wood, but these fungi can reinvade in as little as one year. Many non-decay fungi exhibit considerably greater tolerance to fumigants than decay fungi. Thus, their presence is more of an indicator of future chemical decline than a sign of impending invasion by decay fungi.

Chemical analyses showed that most samples contained elevated levels of MITC 1 year after treatment (**Table I-8**). MITC levels were highest near the groundline and tended to be higher in the inner sampling zone. That latter trend reflects the use of steep sloping holes that tend to

Table I-7. Fungal colonization levels in Douglas-fir and Ponderosa pine distribution poles in San Jose, CA treated with 500 ml of Vapam.

Pole No.	Species	Year installed	Pole Class	Circumference (mm)	Year 0	Year 1			Year 2		
					0 m	0.3 m	0.6 m	1.3 m	0.3 m	0.6 m	1.3 m
3	DF	1961	6	750	0 <sup>100</sup>	0 <sup>0</sup>	0 <sup>0</sup>	0 <sup>0</sup>	0 <sup>0</sup>	0 <sup>0</sup>	0 <sup>0</sup>
5	DF	1961	6	775	0 <sup>100</sup>	0 <sup>0</sup>	0 <sup>0</sup>	0 <sup>0</sup>	0 <sup>0</sup>	0 <sup>0</sup>	0 <sup>0</sup>
6	DF	1961	5	800	0 <sup>100</sup>	0 <sup>0</sup>	0 <sup>0</sup>	0 <sup>0</sup>	0 <sup>0</sup>	0 <sup>0</sup>	0 <sup>0</sup>
7	DF	1961	5	775	0 <sup>100</sup>	0 <sup>0</sup>	0 <sup>0</sup>	0 <sup>0</sup>	0 <sup>0</sup>	0 <sup>0</sup>	0 <sup>0</sup>
8	DF	1959	5	800	0 <sup>100</sup>	0 <sup>0</sup>	0 <sup>67</sup>	0 <sup>33</sup>	0 <sup>50</sup>	0 <sup>0</sup>	0 <sup>0</sup>
9	DF	1960	5	825	0 <sup>67</sup>	0 <sup>0</sup>	0 <sup>0</sup>	0 <sup>0</sup>	0 <sup>100</sup>	0 <sup>33</sup>	0 <sup>33</sup>
10	DF	1961	5	925	0 <sup>67</sup>	0 <sup>0</sup>	0 <sup>0</sup>	0 <sup>0</sup>	0 <sup>0</sup>	0 <sup>0</sup>	0 <sup>0</sup>
11	DF	1961	4	900	0 <sup>100</sup>	0 <sup>0</sup>	0 <sup>0</sup>	0 <sup>0</sup>	0 <sup>0</sup>	0 <sup>0</sup>	0 <sup>0</sup>
14	DF	1962	5	875	0 <sup>67</sup>	-	-	-	0 <sup>0</sup>	0 <sup>33</sup>	0 <sup>0</sup>
15	DF	1963	5	725	0 <sup>67</sup>	-	-	-	0 <sup>0</sup>	0 <sup>0</sup>	0 <sup>0</sup>
16	DF	1963	5	750	0 <sup>100</sup>	-	-	-	0 <sup>0</sup>	0 <sup>0</sup>	0 <sup>0</sup>
Avg.					0 <sup>92</sup>	0 <sup>0</sup>	0 <sup>8</sup>	0 <sup>4</sup>	0 <sup>19</sup>	0 <sup>4</sup>	0 <sup>4</sup>
1	WP	1952	4	975	0 <sup>100</sup>	0 <sup>0</sup>	0 <sup>0</sup>	0 <sup>0</sup>	0 <sup>0</sup>	0 <sup>33</sup>	0 <sup>67</sup>
2	WP	1961	4	900	0 <sup>100</sup>	0 <sup>0</sup>	0 <sup>0</sup>	0 <sup>0</sup>	0 <sup>0</sup>	0 <sup>0</sup>	0 <sup>50</sup>
4	WP	1961	4	850	0 <sup>100</sup>	0 <sup>0</sup>	0 <sup>0</sup>	0 <sup>50</sup>	0 <sup>0</sup>	0 <sup>0</sup>	0 <sup>0</sup>
12	WP	1961	4	975	0 <sup>100</sup>	0 <sup>0</sup>	0 <sup>0</sup>	0 <sup>0</sup>	0 <sup>0</sup>	0 <sup>50</sup>	0 <sup>50</sup>
13	WP	-	4	975	0 <sup>0</sup>	0 <sup>0</sup>	0 <sup>0</sup>	0 <sup>0</sup>	0 <sup>0</sup>	0 <sup>0</sup>	0 <sup>0</sup>
Avg.					0 <sup>80</sup>	0 <sup>0</sup>	0 <sup>0</sup>	0 <sup>10</sup>	0 <sup>0</sup>	0 <sup>17</sup>	0 <sup>33</sup>

a. Values reflect the means of 2 or 3 samples per pole per height.  
 Values in regular script represent decay fungi while values superscript represent nondecay fungi.



Table I-8. Residual methylisothiocyanate levels in Douglas-fir and ponderosa pine distribution poles in San Jose, California; 1 and 2 years after treatment with 475 ml metham sodium.

Pole No.	Wood Species	Year	ug MITC/g O.D. Wood					
			0.3 m		0.6 m		1.2 m	
			inner	outer	inner	outer	inner	outer
3	DF	1	514	485	293	272	0	0
		2	235	184	356	126	10	7
5	DF	1	640	68	165	28	0	0
		2	727	314	194	102	9	7
6	DF	1	316	387	42	40	0	0
		2	171	162	133	35	3	0
7	DF	1	192	0	123	34	0	0
		2	212	16	91	18	0	0
8	DF	1	73	26	9	14	13	1
		2	30	19	13	11	10	5
9	DF	1	223	106	122	49	0	0
		2	94	57	78	52	6	0
10	DF	1	78	113	6	18	0	0
		2	72	13	29	2	0	0
11	DF	1	204	50	30	20	0	0
		2	79	0	46	26	6	0
14	DF	1	--	--	--	--	--	--
		2	218	95	205	55	0	0
15	DF	1	--	--	--	--	--	--
		2	111	93	105	71	0	0
16	DF	1	--	--	--	--	--	--
		2	10	5	44	34	64	82
Avg.		1	280 (189)	154 (168)	99 (92)	59 (81)	2 (4)	0 (1)
		2	178 (188)	87 (94)	118 (96)	48 (37)	10 (18)	9 (23)
1	WP	1	184	36	41	30	0	1
		2	76	17	49	0	0	0
2	WP	1	23	87	2	41	0	2
		2	213	0	20	27	6	0
4	WP	1	16	51	0	7	2	0
		2	79	27	10	16	2	0
12	WP	1	17	12	24	14	3	9
		2	0	0	0	0	0	0
13	WP	1	111	50	47	20	9	10
		2	60	0	24	0	5	0
Avg.		1	70 (67)	47 (25)	23 (19)	23 (12)	3 (3)	4 (4)
		2	86 (70)	9 (11)	20 (16)	9 (11)	2 (2)	0 (0)

\* Treated by Davey Tree in 1996.

channel the fumigant to the center of the pole. Fumigant levels were higher in Douglas-fir than ponderosa pine, although the limited pine sample makes it difficult to draw definitive conclusions. MITC levels declined 0.3 above groundline for Douglas-fir between one and two years, but changed little 0.3 m above this zone. Chemical levels 1.2 m from the groundline increased between 1 and 2 years, but the overall levels remained low.

MITC levels in ponderosa pine poles increased in the inner zone 0.3 m above groundline, but declined in the outer zone. More importantly, MITC levels declined in both the inner and outer zones 0.6 and 1.2 m above groundline. The reasons for these declines are unclear. Ponderosa pine is often considered to be similar to southern pine in terms of its permeability and treatment characteristics. Our results suggest that metham sodium will be less effective in ponderosa pine. As a result, shorter treatment cycle may be required where this species is used under more severe decay conditions.

We will sample these poles next year to confirm the trends and develop a better understanding of the possible performance differences between ponderosa pine and Douglas-fir.

**7. Effect of decay voids on fumigant movement and effectiveness in Douglas-fir poles:** The presence of internal voids can cause considerable problems for inspectors attempting to apply internal remedial treatments. The *Wood Pole Maintenance Manual* recommends that inspectors continue drilling at increasing distances above or below a void until the hole goes through sound wood. While this is relatively simple to accomplish, many utilities remain concerned about the ability of the internal remedial treatments to move across the void to completely protect the decaying wood from further attack. Some utilities employ internal void treatments that contain either an oilborne preservative that coats the void or a water soluble preservative that diffuses from the void to kill fungi in the wood. However, it may also be possible to accomplish the same task

through fumigant diffusion from application sites above or below the void.

In 1987, twelve pentachlorophenol treated Douglas-fir poles (200 to 250 mm in diameter by 3 m long) were cut in half and a 50 mm diameter by 150 mm long hole was cut into the exposed, untreated cross section of each half. The void was filled with brown rotted wood and the two halves were reassembled. The outer face of the joint was sealed with an elastomeric sealant to retard lateral fumigant loss, then a set of brackets were attached and used to tighten the gap between the two halves and simulate a pole with a 300 mm long void. The poles were then treated with 80 or 160 ml of metham sodium or chloropicrin applied to holes drilled above the void. Each treatment was applied to three poles and the poles were exposed outdoors, but under cover at the Forest Research Laboratory.

The poles were sampled 3, 5, 8, and 10 years after treatment by removing increment cores from three equidistant locations around the poles 0.3 m and 0.9 m above or below the void. The outer, treated zone was discarded and the outer and inner 25 mm of the remainder of the core was placed in 5 ml of ethyl acetate (for metham sodium) or hexane (for chloropicrin). The cores were extracted for 48 hours, then the extract was analyzed for either chloropicrin or methylisothiocyanate. The results were expressed on a ug of chemical per wood weight basis.

Four poles in the test have fallen apart at the joint as a result of the weakness of the original bracket system. MITC was virtually absent from both the void and non-void poles 10 years after treatment, a finding that was similar to that noted for the MITC-Fume treated poles 9 years after treatment (**Table I-9**). Over the course of the treatment, the presence of voids had little or no influence on resulting chemical concentrations below the void, suggesting that the chemical was capable of diffusing across the void to protect the wood below that zone.

Unlike MITC, chloropicrin remained detectable in a number of pole sections 10 years after treatment, although the levels were sometimes low (**Table I-10**). Once again, however, there appeared to be little difference between poles with and without voids.

Table I-9. Residual methylisothiocyanate levels in Douglas-fir poles with or without simulated voids 3 to 10 years after treatment with 80 or 160 g of metham sodium.

Dosage (g)	Void (+/-)	Distance from void (m)	Average MITC content (ug/g oven dry wood)							
			Inner				Outer			
			3 yr	5 yr	8 yr	10 yr	3 yr	5 yr	8 yr	10 yr
80	+	-0.9	3	2	17	0	3	0	13	4
		-0.3	9	3	16	0	14	8	16	1
		0.3	15	2	16	0	11	1	14	3
		0.9	3	1	15	0	3	2	15	0
80	-	-0.9	3	3	25	0	0	2	22	1
		-0.3	15	5	21	0	9	5	16	0
		0.3	12	1	13	0	7	2	12	1
		0.9	2	4	12	1	0	1	10	1
160	+	-0.9	5	2	15	0	0	4	16	2
		-0.3	20	5	14	0	8	3	14	3
		0.3	32	12	11	0	12	5	11	1
		0.9	10	1	12	0	4	0	11	0
160	-	-0.9	3	5	13	1	2	11	11	3
		-0.3	45	12	14	1	28	12	14	1
		0.3	38	11	13	1	22	13	11	1
		0.9	5	4	14	3	5	6	13	1

Table I-10. Residual chloropicrin levels in Douglas-fir poles with or without simulated voids 3 to 10 years after treatment with 80 or 160 g of chloropicrin.

Dosage (g)	Void (+/-)	Distance from void (m)	Average chloropicrin content (ug/g oven dry wood)					
			Inner			Outer		
			3 yr	8 yr	10 yr	3 yr	8 yr	10 yr
80	+	-0.9	164	0	0	8	0	0
		-0.3	223	30	0	79	16	0
		0.3	353	3	0	170	27	0
		0.9	28	0	0	2	0	0
80	-	-0.9	55	4	0	14	58	2
		-0.3	507	159	33	151	69	59
		0.3	608	122	37	253	113	7
		0.9	107	29	0	14	4	0
160	+	-0.9	224	5	1	27	6	0
		-0.3	822	31	0	358	18	5
		0.3	621	48	0	236	20	0
		0.9	335	17	0	22	7	0
160	-	-0.9	215	13	0	12	7	0
		-0.3	585	146	6	167	204	26
		0.3	488	166	25	146	191	8
		0.9	233	5	0	28	4	0

While the void test was artificial, it suggests that both MITC and chloropicrin were capable of diffusing across 300 mm long voids to protect wood on either side of a simulated decay pocket. These results indicate that judicious drilling to ensure that chemical is applied into solid wood should result in a fumigant distribution that protects wood surrounding a decaying void.

**8. Preliminary field trials to evaluate Basamid in Douglas-fir heartwood:** Basamid is a solid chemical which decomposes to produce MITC as one of its fungitoxic products. This chemical has excellent stability at room temperature, a property which makes it an ideal candidate for improved applicator safety, but one which decreases its effectiveness as a wood treatment. Preliminary laboratory trials suggest that Basamid decomposition is more efficient at higher pHs. Unfortunately, the pH of Douglas-fir heartwood ranges from 3.0 to 3.5, far below the optimum levels of Basamid decomposition. As an alternative, it may be possible to alter the pH around the treatment hole to encourage Basamid decomposition by addition of selected high pH buffers.

Preservative treated Douglas-fir pole sections (1.8 m long) were treated with 75 g of Basamid distributed between three holes at the center of the section. One set of three poles received 100

ml of pH 10 buffer, a second set received a similar amount of pH 12 buffer and the third received no supplemental liquid. The holes were plugged with tight fitting wood dowels and the poles were exposed outdoors at the Forest Research Laboratory.

The poles were sampled 2, 3, 4, 5, and 10 years after treatment by removing three increment cores from around the pole at 120 degree intervals 0.3 m above and below the treatment holes. The outer and inner 25 mm of each core was extracted in ethyl acetate and analyzed for residual MITC content by gas chromatography.

MITC levels in the poles sections were low 2 years after treatment and increased sharply after an additional year of exposure (Table I-11). MITC levels fluctuated somewhat between the 2 and 5 year sampling. Initially, it appeared that the addition of pH 12 buffer produced a slight enhancement in MITC levels in the poles, but continued sampling suggests that if there was an increase, the effect was temporary and probably did not warrant the additional cost for the buffer. Coniferous wood generally has a strong buffering capacity. As a result, the potential for permanently affecting pH around the treatment is probably limited. The results to illustrate that MITC continues to be present within 0.3 m of the treatment site 10 years after application of a relatively small amounts of Basamid.

Table I-11. MITC levels in increment core samples removed from Douglas-fir pole sections treated with 75 g of Basamid with or without 100 ml of a pH 10 or 12 buffer.

Treatment	Sampling Height (m)	Average MITC content (ug/g o.d. wood)									
		inner					outer				
		2 yr	3 yr	4 yr	5 yr	10 yr	3 yr	4 yr	5 yr	10 yr	
75 g Basamid	-0.9			0	1	0		0	3	0	
	-0.3	5	28	6	21	7	9	5	17	5	
	0.3	7	10	7	26	9	7	2	20	6	
	0.9			0	0	1		0	0	1	
75 g Basamid pH 10 buffer	-0.9			<1	8	1		0	6	1	
	-0.3	2	13	2	15	7	4	3	24	5	
	0.3	4	17	7	10	6	14	2	19	6	
	0.9			0	4	1		0	1	1	
75 g Basamid pH 12 buffer	-0.9			0	5	2		<1	13	1	
	-0.3	8	30	5	32	15	23	5	34	9	
	0.3	4	17	14	18	5	13	5	33	6	
	0.9			<1	3	1		0	65	1	



## **B. ABILITY OF WATER DIFFUSIBLE TREATMENTS TO ARREST AND PREVENT INTERNAL DECAY.**

While fumigants have served as the primary tool for arresting and preventing internal decay in utility poles, there are some locations where the volatility of some fumigants or concerns about spills have limited their application. Water diffusible boron and fluoride based biocides have emerged as potential substitutes for these application. The fungicidal effectiveness of both boron and fluoride have long been known, but there is less information on their effectiveness in rod or paste formulation particularly on North American wood species used for utility poles. In an effort to develop this data, the following trials have been established.

**1. Evaluation of a boron/fluoride rod in Douglas-fir poles:** The poles treated with boron/fluoride rods were not sampled in 1997. They will be sampled in 1998 and the results will be provided in the next annual report.

**2. Evaluation of fused boron rods in Douglas-fir poles:** Over the past decade, we have established a series of trials to evaluate the effectiveness of fused boron rods in Douglas-fir poles. All of these trials were sampled in 1997, but the analytical results have not been provided by the commercial cooperator. We recently asked for the return of these samples and will perform the analyses in our laboratory. The results will appear in the next annual report.

**3. Evaluation of fused borate rods plus glycol for enhanced diffusion in Douglas-fir poles:** The Douglas-fir poles treated with combinations of fused borate rod and glycol were sampled in both 1997 and 1998 and the results will be reported in the next annual report.

Fluoride has long been used as a remedial treatment for controlling internal decay in railroad ties. This material has recently been labeled for application to wood poles, but there is relatively little data on the ability of sodium fluoride to diffuse from the rod into the surrounding pole. Twenty pentachlorophenol-treated Douglas-fir pole sections (250 to 300 mm in diameter by 2.4 m long) were set to a depth of 0.6 m at the Peavy Arboretum test site. Three 19 mm diameter by 200 mm long holes were drilled into the poles beginning at groundline and moving upward at 150 mm intervals and 120 degrees around the pole. Each hole received 1 or 2 sodium fluoride rods (Flurod, Osmose Wood Preserving Inc.), then the holes were plugged with tight fitting wooden dowels. Each treatment was assessed on ten poles.

Fluoride movement was evaluated 1 and 2 years after treatment by removing increment cores from three sites around each pole 150 mm below the groundline, 225 mm above the groundline, and 150 mm above the highest treatment hole (450 mm above groundline).

The outer, treated shell was discarded, then the remaining core was divided into inner and outer halves. Cores from a given height and treatment were combined prior to grinding to pass a 20 mesh screen. Initially, a hot water extract of sawdust was analyzed using a specific ion electrode for fluoride. In examining the results, it was noted that the fluoride levels were lower than expected. We sent seven coded samples to be analyzed by Osmose Wood Preserving (Buffalo, New York) in an effort to determine whether our analysis was flawed. The results were markedly higher than those produced by hot water extraction. To resolve this problem, we sent the residual sawdust from each sample to Osmose for analysis using AWPA Standard A2 Method 7 which involves ashing the wood to remove contaminants that might interfere with fluoride extraction. The analyses were performed on a blind sample basis.

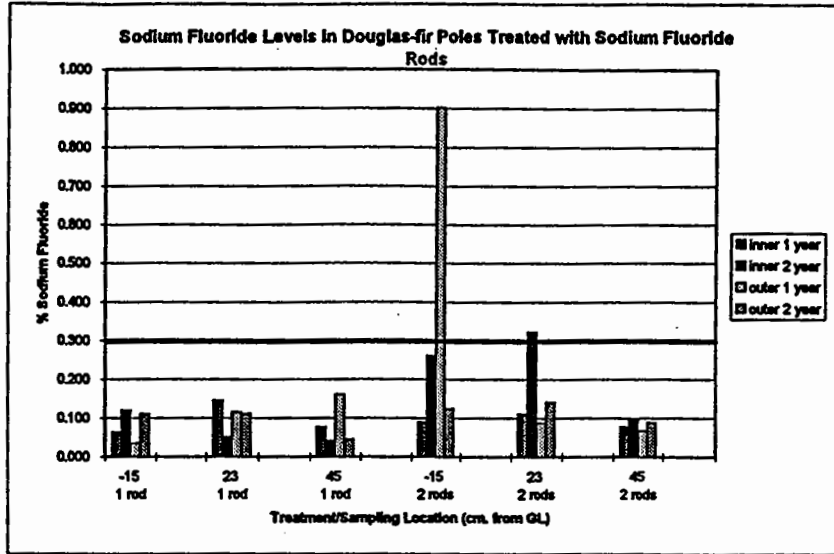

Figure I-5. Residual fluoride levels at selected distances from the groundline of Douglas-fir poles 1 or 2 years after treatment with 3 or 6 sodium fluoride rods distributed between three holes drilled around the groundline.

Table I-12. Residual fluoride in Douglas-fir poles 1 and 2 years after treatment with 1 or 2 sodium fluoride rods in each of three treatment holes.

Dosage	Distance from Groundline (mm)	inner		outer	
		1 year	2 year	1 year	2 year
1 rod/hole	-150	0.062	0.120	0.035	0.110
		0.085	0.149	0.013	0.117
1 rod/hole	230	0.145	0.051	0.115	0.111
		0.252	0.049	0.232	0.134
1 rod/hole	450	0.076	0.041	0.160	0.044
		0.085	0.060	0.212	0.044
2 rods/hole	-150	0.089	0.260	0.903	0.123
		0.074	0.275	2.172	0.100
2 rods/hole	230	0.110	0.322	0.087	0.141
		0.137	0.261	0.128	0.147
2 rods/hole	450	0.077	0.095	0.067	0.088
		0.117	0.095	0.077	0.089

a. Values represent means of 8 analyses per 1 rod treatment and 7 analyses per 2 rod treatment. Figures in parentheses represent one standard deviation. Sampling heights above or below groundline. Cores were divided into inner and outer halves prior to analyses.

**4. Performance of sodium fluoride rods in Douglas-fir poles:** Previous studies suggest that the threshold for protection of wood from fungal attack using fluoride is 0.3 % (wt./wt). Using this level as a target, only the inner zone of the 2 rod treatment at the 230 mm sampling location contains an adequate level of fluoride (**Figures I-5, Table I-12**). Fluoride levels in the inner zone 150 mm below ground on these pole also approaches the threshold. The remaining analyses remain well below the threshold. The presence of measurable fluoride at all locations demonstrates that the fluoride is moving well through the heartwood, but the low levels of chemical suggest that the initial dosage may be too low to produce the desired retention in the wood. In addition, detection of fluoride at the 450 mm sampling location suggests that the chemical has moved well upward from the point of application, possibly following the normal cone shaped moisture pocket that forms at the groundline of these poles during the wetter winter months. These poles have been resampled in 1998 to provide a more continuous chemical record.

**5. Diffusion of copper and boron from a copper naphthenate/boron paste:** While boron and fluoride rods have received extensive attention as potential internal remedial treatments, other diffusible formulations may also prove useful for this application. Among these is a copper naphthenate/boron paste which is typically used as a supplemental groundline preservative (CuRAP, 20, ISK Biosciences). In 1989, a series of Douglas-fir poles stubs (25-30 cm in diameter by 2.0 m long) were set to a depth of 0.6 m and treated with 150 or 300 g of the copper naphthenate/boron paste through a series of three 22 mm diameter holes drilled at a 45-degree angle beginning at groundline and moving upward 15 cm and around the pole 120 degrees. Ten poles each received 150 or 300 g of a paste containing 18.16% amine based copper naphthenate and 40% sodium tetraborate decahydrate. The chemical was applied using a grease gun and the holes were plugged with tight fitting wooden dowels.

Chemical movement was assessed 3 and 5 years after treatment by removing increment cores

from three equidistant sites around the pole 8 cm below the groundline as well as 8, 16, 24, and 32 cm above groundline. The cores were divided into inner and outer halves and each was ground to pass a 20 mesh screen. Copper content was determined using an ASOMA 8620 x-ray fluorescence analyzer (XRF), while boron content was determined using American Wood Preservers' Association Standard A2 (Asomethine H method). Copper and boron levels in most samples were consistently higher in the inner zones than the outer zones, ~~reflecting the use of downward sloping holes~~ and the tendency for chemicals to diffuse downward to a greater extent along these holes (**Tables I-13**). Copper levels were similar at 80, 150 and 230 mm above the groundline and did not appear to vary markedly over the three sampling periods (**Figures I-6**). The amine copper is initially water soluble, however, its solubility declines substantially once the amine is lost. As a result, the greater copper movement probably occurs shortly after treatment and any subsequent movement should be sharply lower. Our results seem to reflect that possibility. As expected, copper levels were highest in poles receiving the higher dosage of paste.

Boron levels in the poles followed trends that differed from those found with copper. Boron levels in most locations tended to increase steadily over the 3 sampling times, particularly 80, 150, and 230 mm above the groundline (**Figures I-7**). Boron levels were much lower 80 mm below groundline, reflecting the higher potential for leaching losses in this zone.

Boron levels tended to be slightly higher in the inner zones and were generally higher in the higher dosage treatment, although the differences were often not as great as those found with copper nor were they proportional to the dosage differential. In general, however, the boron levels in the inner zones at 80, 150 and 230 mm above groundline were at or above the 0.5 % BAE level normally considered to be the threshold for fungal attack. In the next section, we will discuss results of other trials designed to determine more realistic threshold values, but for the present, we have used the 0.5 % value.

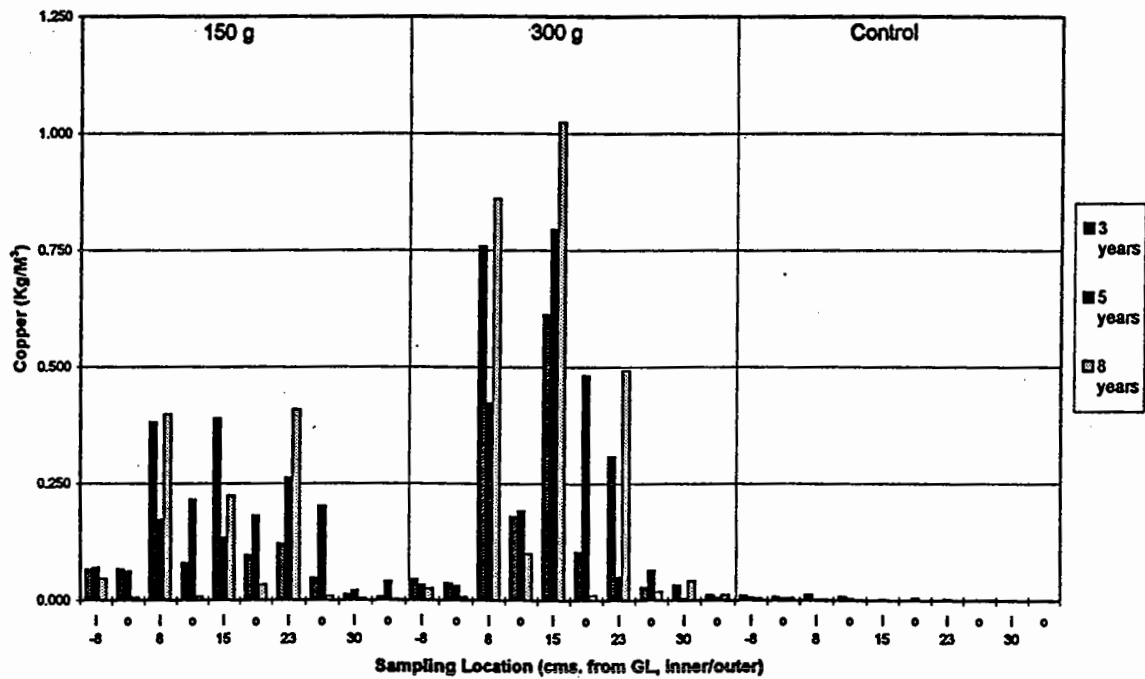

Figure I-6. Residual copper naphthenate in Douglas-fir poles 3 to 8 years after application of a copper naphthenate/boron paste.

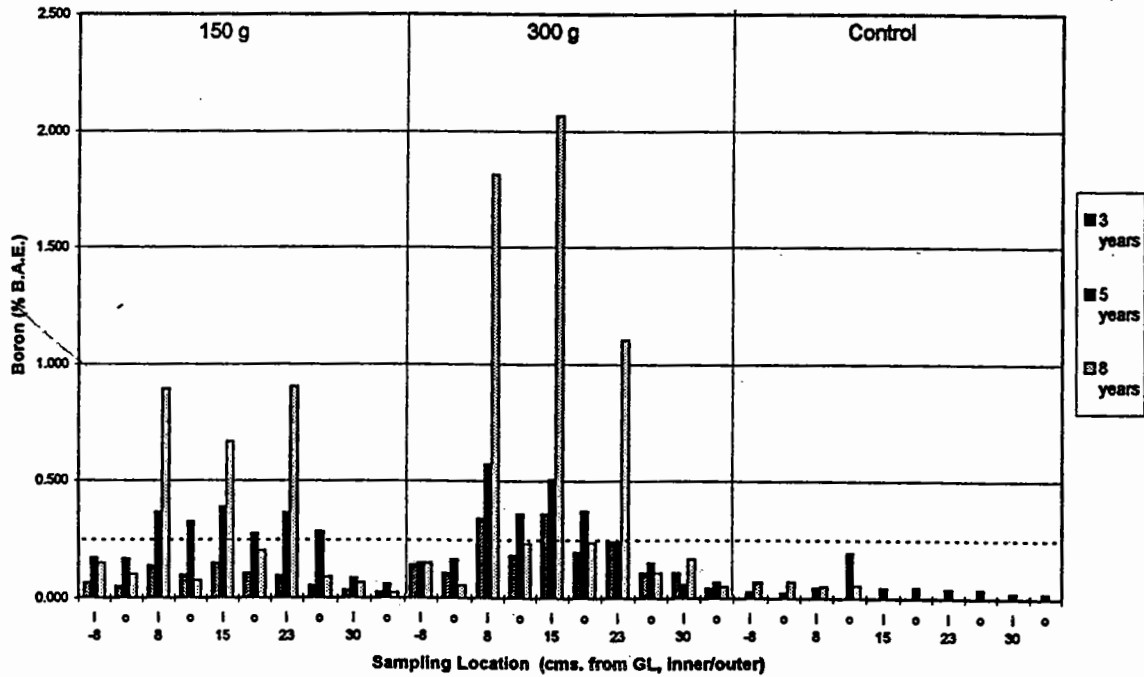

Figure I-7. Residual boron in Douglas-fir poles 3 to 8 years after application of a copper naphthenate/boron paste.

The results indicate that the both components of the paste moved well from the point of application and remain in the wood 8 years after application.

Analyses of cores removed 3 years after treatment revealed that boron was present at levels ranging from 0.06 to 1.15% boric acid equivalent (BAE), while copper levels ranged from 0.01 to 0.54 kg/m<sup>3</sup> (Table I-13). Chemical levels were generally higher at or slightly above the groundline, reflecting the application pattern. Chemical levels were generally higher in the inner zones of the poles, again reflecting the application pattern. As expected, chemical levels also increased with increased dosage and decreased with increasing distance away from the groundline.

#### **6. Development of threshold values for boron in**

**Douglas-fir:** Boron has a long history of usage as both an initial and remedial treatment for preventing fungal attack of wood. From an efficacy standpoint, one of the major advantages of boron is its ability to move with moisture throughout wood. The mobility of boron, however, has posed a substantial challenge to those attempting to develop reliable estimates of the dosages required to arrest fungal or insect attack. This is particularly true with organisms such as fungi that require wet wood for attack.

For example, the American Wood Preservers' Association Standard E10 for establishing thresholds of chemicals against wood degrading fungi exposes treated blocks to the test fungus established on wood feeder wafers over soil (AWPA, 1996a). While there is no direct soil contact, there is potential for leaching of boron from the test block into the wet feeder wafer as well as the possibility that nutrients can be translocated by the fungus from the soil into the test block. This potential is often shown by the death of the test fungus on feeders when blocks treated to higher boron retentions are evaluated. While this ability to migrate to and eliminate fungi is an important characteristic of boron, it makes it difficult to accurately determine the levels of boron required to prevent colonization of wood. Previous studies suggest that the levels of boron

required for preventing fungal attack can vary widely (DeJonge, 1986; Findlay, 1953, 1959; Lloyd, 1997; Sheard, 1990; Williams and Amburgey, 1987; Cockcroft and Levy, 1973; Cserjesi and Swann, 1969; Carey and Bravery, 1987). These differences reflect, in part, the degree to which the boron could migrate over the test period. Ideally, such tests would expose treated blocks to either spores or hyphae of the test fungus, rather than the assembled mycelial masses characteristics of most laboratory decay tests in a non-leaching exposure. The inoculum would more closely approximate the potential infestation routes for fungi in buildings and other above ground decay exposures for which boron treated wood might be used. The development of more precise boron threshold values might permit more rational retention recommendations where fungal rather than termite attack was the dominant cause of deterioration.

In this report, we describe preliminary results of tests to establish threshold levels for boron against two wood decay fungi in Douglas-fir heartwood and sapwood in a modified laboratory above ground test.

Douglas-fir (*Pseudotsuga menziesii* (Mirb.) Franco) sapwood and heartwood wafers (5 by 10 by 30 mm long) were cut from lumber that was free of defects and visible evidence of microbial colonization. A single, 0.5 mm diameter by 2 mm long hole was drilled into one wide face of each wafer to serve as an inoculation point. The wafers were oven dried (54°C) overnight and weighed (nearest 0.001 g). The wafers were then allocated to 7 groups. Solutions of disodium octaborate tetrahydrate were prepared to produce boron levels of 0.03, 0.05, 0.09, 0.17, 0.23, and 0.36 % boric acid equivalent (BAE) in heartwood blocks or 0.03, 0.09, 0.21, 0.31, 0.32, or 0.46 % BAE in sapwood blocks on a wt/wt basis. The blocks were treated by immersion in the desired test solution. A short vacuum was drawn over the solution (80 kPa for 15 minutes), then a 1 hour pressure period was applied (800 kPa). Following treatment, the blocks were wiped clean and weighed to determine gross solution uptake. Selected blocks from each treatment group were immediately oven dried and ground to pass a 20 mesh screen. Boron content was determine using

the Azomethine H/Carminic Acid method (AWPA, 1996).

The remaining wafers in a given treatment group were placed into plastic bags and subjected to 2.5 Mrads from a cobalt 60 source. The wafers were then placed on glass rods on top of moistened filter paper in glass petri dishes. The glass dishes with the filter paper and rods had previously been sterilized by heating at 121°C for 30 minutes.

Wafers were inoculated with either *Gloeophyllum trabeum* (Pers.: Fr.) Murr. (Isolate # MAD-617) or *Trametes versicolor* (L:Fr.) Pilat (Isolate R-105). Agar discs of the test fungus were inoculated into flasks containing 1.5 % malt extract and these flasks were incubated on a rotary shaker for 14 days at room temperature (23-25°C). The resulting mycelial growth was filtered and washed with sterile distilled water, then the filtrate was resuspended in sterile distilled water prior to being blending for 4 seconds. Each wafer received 100 ul of the resulting mycelial fragment/spore suspension applied to the small hole drilled into the wood surface. The petri dishes were then sealed with Parafilm and incubated at 28°C for 16 or 21 weeks for *G.*

*trabeum* or *T. versicolor*, respectively. The assembly permitted exposure of moist boron treated wafers to fungal spores or hyphae in a nearly non-leaching exposure.

At the end of the test period, the wafers were removed, scraped clean of adhering mycelium and oven-dried (54°C) prior to being weighed to determine wood weight loss over the exposure period.

Hyphal growth became evident within 4 weeks on untreated wafers exposed to *G. trabeum* and after 8 to 10 weeks on wafers exposed to *T. versicolor* (Figure I-8). Weight losses for untreated control wafers exposed to the two test fungi varied widely. The highest weight losses were found with exposure of Douglas-fir sapwood to *G. trabeum*, while Douglas-fir heartwood wafers exposed to *T. versicolor* experienced little or no weight loss (Table I-14). Weight losses were generally lower with Douglas-fir heartwood than sapwood, reflecting the moderately durable heartwood characteristic of this species (Scheffer and Cowling, 1966).

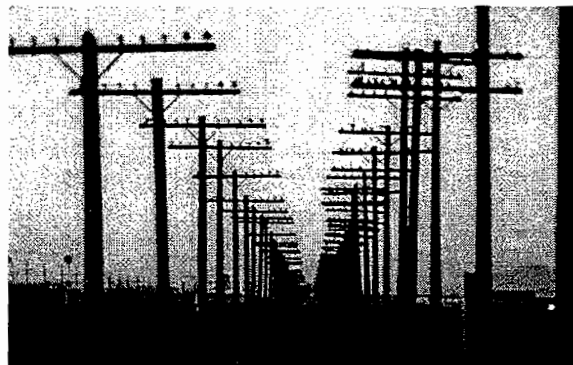

Table I-13. Residual copper and boron in Douglas-fir poles internally treated with 150 or 300 g of a copper naphthenate/boron paste.

Dosage (grams)	Sampling height (mm)	Zone	Boron (%B.A.E.)			Copper Retention (% Cu) (Kg/M <sup>3</sup> )		
			3 year	4 year	8 year	3 year	4 year	8 year
150	-75	inner	0.149	0.170	0.064	0.047	0.071	0.067
150	-75	outer	0.101	0.167	0.048	0.006	0.063	0.066
150	75	inner	0.893	0.366	0.136	0.398	0.173	0.381
150	75	outer	0.074	0.323	0.096	0.008	0.216	0.079
150	150	inner	0.666	0.388	0.147	0.223	0.135	0.389
150	150	outer	0.203	0.274	0.104	0.033	0.181	0.096
150	225	inner	0.903	0.362	0.093	0.409	0.263	0.120
150	225	outer	0.089	0.283	0.051	0.009	0.201	0.048
150	300	inner	0.064	0.084	0.034	0.004	0.022	0.012
150	300	outer	0.024	0.060	0.025	0.002	0.040	0.007
300	-75	inner	0.148	0.151	0.142	0.026	0.034	0.044
300	-75	outer	0.054	0.164	0.105	0.007	0.031	0.036
300	75	inner	1.813	0.570	0.338	0.861	0.423	0.759
300	75	outer	0.232	0.359	0.180	0.100	0.192	0.179
300	150	inner	2.067	0.505	0.359	1.023	0.795	0.612
300	150	outer	0.237	0.371	0.195	0.010	0.482	0.104
300	225	inner	1.104	0.238	0.239	0.493	0.051	0.308
300	225	outer	0.107	0.151	0.107	0.019	0.064	0.028
300	300	inner	0.167	0.060	0.107	0.042	0.003	0.032
300	300	outer	0.051	0.068	0.042	0.012	0.007	0.012
none	-75	inner	0.068	0.027	0.000	0.004	0.006	0.011
none	-75	outer	0.069	0.022	0.000	0.005	0.005	0.008
none	75	inner	0.050	0.045	0.000	0.002	0.001	0.013
none	75	outer	0.054	0.194	0.000	0.000	0.004	0.008
none	150	inner	--	0.044	--	--	0.002	--
none	150	outer	--	0.046	--	--	0.005	--
none	225	inner	--	0.039	0.000	--	0.003	0.000
none	225	outer	--	0.038	0.000	--	0.001	0.000
none	300	inner	--	0.023	--	--	0.001	--
none	300	outer	--	0.022	--	--	0.000	--

Table I-14. Effect of boron retention on weight losses in Douglas-fir heartwood or sapwood blocks exposed to *G. trabeum* or *T. versicolor* in an simulated above ground decay test.

Retention (%BAE)	Heartwood Weight Loss (%)		Retention (% BAE)	Sapwood Weight Loss (%)	
	<i>G. trabeum</i>	<i>T. versicolor</i>		<i>G. trabeum</i>	<i>T. versicolor</i>
0	9.6 (1.0)	0.2 (0.6)	0	21.6 (1.1)	7.3 (2.0)
0.03	9.1 (1.3)	0.3 (0.6)	0.03	19.7 (4.2)	5.2 (0.5)
0.05	2.6 (0.6)	1.0 (0.5)	0.09	2.5 (2.1)	2.0 (0.9)
0.09	1.0 (0.5)	1.0 (0.4)	0.21	1.6 (0.3)	1.2 (1.0)
0.17	1.2 (0.4)	0.9 (0.3)	0.31	0.9 (0.3)	0.2 (0.3)
0.23	0.9 (0.4)	1.9 (0.3)	0.32	0.8 (0.2)	0.0 (0.9)
0.36	0.9 (0.3)	1.0 (0.6)	0.46	0.5 (0.3)	-0.4 (0.6)

<sup>a</sup> Values represent means of 6 values per treatment. Figures in parentheses represent one standard deviation

Weight losses were also consistently greater in wafers exposed to *G. trabeum*, a reflection of the preference of brown rot fungi for coniferous wood, particularly in non-soil contact exposures (Zabel and Morrell, 1992). Little or no weight loss was found when Douglas-fir heartwood was exposed to *T. versicolor*, while weight losses in untreated sapwood controls exposed to this same fungus were only one third of those found with *G. trabeum*.

Weight losses in borate treated Douglas-fir sapwood were generally negligible when the BAE percentage exceeded 0.1 %, regardless of the test fungus. Plots of the data suggest that the thresholds for fungal weight loss were 0.09 and 0.10 % BAE, for *G. trabeum* and *T. versicolor*, respectively. It was not possible to calculate a threshold for Douglas-fir heartwood exposed to *T. versicolor*, but the threshold for borates against *G. trabeum* appeared to be 0.08 % BAE. The relatively small difference between threshold in sapwood and heartwood against this fungus were surprising, especially given the 2.5 fold difference in weight losses in non-borate treated sapwood and heartwood controls. This finding implies that there is relatively little interaction between the borate and the extractives present in this wood with regard to activity against the two decay fungi

tested. The thresholds found with one of the test fungi were similar to those noted by G. Becker in a report by Findlay (1959), where the toxic threshold for *G. trabeum* was reported to be between 0.075 and 0.2 %, but are far lower than the 0.44 % BAE reported by Williams and Amburgey (1989) or the 0.5 to 0.9 % BAE reported by Harrow. The latter two data sets were developed using the soil block procedure and leaching may have artificially inflated the threshold values. Soil contact can not only provide a medium for boron loss, it might also provide micro-nutrients that could enhance microbial colonization. As a result, these data, while providing guidance under more severe exposures, are probably not representative of a true non-leaching above ground exposure such as might be found in an interior wall or beneath a bath fixture.

Thresholds for boron against two decay fungi in Douglas-fir sapwood and heartwood wafers exposed in non-soil contact were somewhat lower than previously reported. The absence of large volumes of inoculum and the lack of soil contact appear to influence boron toxicity in this system and imply that boron retentions required for protection against fungal attack may be lower than currently specified.



### Weight loss of Boron treated Douglas-fir sapwood

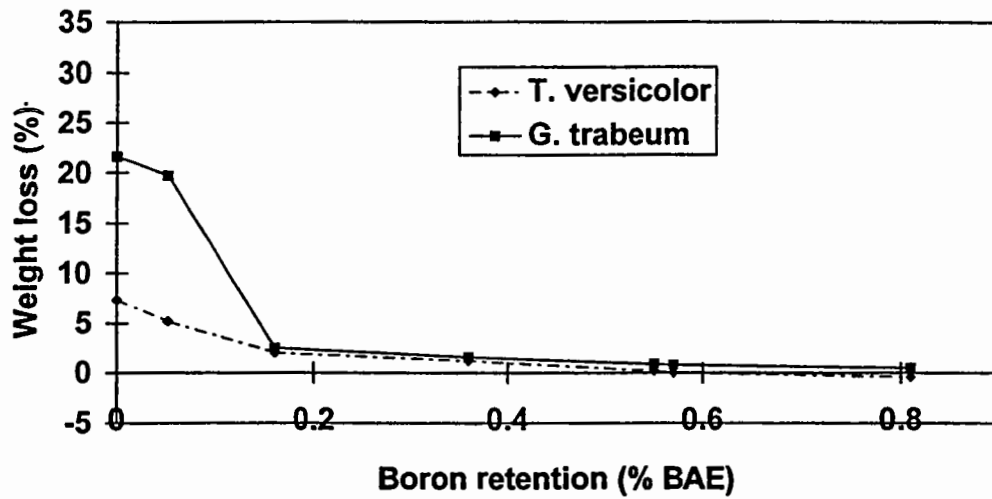

### Weight loss of Boron treated Douglas-fir heartwood

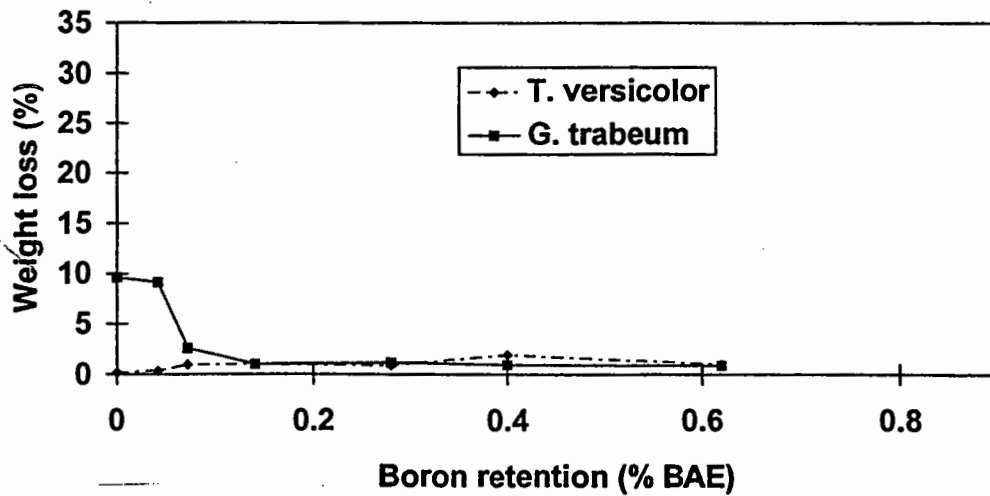

Figure I-8. Weight losses in non-treated and borate treated Douglas-fir sapwood and heartwood blocks exposed to *G. trabeum* or *T. versicolor* in a non-soil contact decay test.

# OBJECTIVE II

## IDENTIFY CHEMICALS FOR PROTECTING EXPOSED WOOD SURFACES IN POLES

While preservative treatment creates an excellent barrier against fungal and insect attack, many wood users compromise this treatment by drilling holes or making cuts in the wood that penetrate beyond the depth of the original treatment. This damage permits entry of water and fungal spores into the exposed untreated wood, and eventually leads to the development of internal decay. The most effective method for preventing this damage is to make all cuts and bore holes prior to treatment but this is not always possible. The alternative to pre-boring and cutting is to apply a preservative solution to the freshly cut surface. The most common preservative used for this purpose is a copper naphthenate solution in diesel (2% as Cu). While this treatment provides some protection, the oily nature is not popular with line personnel who feel that it fouls their gloves. As a result, post boring treatments are infrequently applied. A compounding factor is the preponderance of underbuilt lines on poles for various communications companies. Line personnel for these entities have little vested interest in performance of the pole and are less likely to apply remedial treatments when they bore holes for cable or other attachments. Complicating this problem is the difficulty of confirming whether a treatment was applied. Utilities are unlikely to remove a cross arms or other fixture to confirm that the required topical treatment was applied.

A number of years ago, we initiated a series of field tests to evaluate several alternative remedial treatments. At that time, we also explored the need for such treatments. Surveys over the years suggest that between 10 and 25% of field drilled bolt holes contain active decay, a figure which could markedly reduce pole service life if allowed to progress unchecked. As a result, we continue to explore alternative methods for preventing decay in field cuts.

### A. EVALUATION OF TREATMENTS FOR PROTECTING FIELD DRILLED BOLT HOLES:

Trials to evaluate the effectiveness of various treatments for protecting exposed heartwood in Douglas-fir poles are continuing. In 1981, Douglas-fir pole sections were treated with pentachlorophenol in heavy oil by Boultonizing to produce a relatively shallow shell of treatment.

A series of eight 25 mm diameter holes was drilled at 90 degree angles into the poles beginning 600 mm above the groundline and extending upward at 450 mm intervals to within 450 mm of the top. The holes on a given pole were treated with 10% pentachlorophenol in diesel oil, powdered ammonium bifluoride (ABF), powdered disodium octaborate tetrahydrate (Boron), or 40% boron in ethylene glycol (Boracol). Each chemical was replicated in eight holes on each of four poles. An additional set of four poles did not receive chemical treatment but chemically impregnated washers containing 37.1 sodium fluoride, 12.5%, potassium dichromate, 8.5% sodium pentachlorophenate, 1% sodium tetrachlorophenate, and 11% creosote (PATOX) were used to attach the bolts to these poles. Holes were drilled in an additional eight poles that received no chemical treatment. The bolt holes were filled with galvanized metal hardware and either metal or plastic gain plates.

For the first 5 years, increment cores were only removed from four of the control poles at sites directly below the gain plate on one side of the pole and from sites directly above the washer on the opposite side. These cores were cultured on malt extract agar and observed for the growth of basidiomycetes, a class of fungi that includes many important wood decayers. Once a sufficient level of fungal colonization was present in the control sample, the remainder of the poles were sampled in the same manner.

The field trial is now in its 16th year. The levels of fungal colonization have steadily increased over the last 3 years, reflecting either loss of chemical protection, increased biological attack as a result of above average rainfall, or a combination of the two (**Figure II-1**). Fungal isolations from the untreated control bolt holes increased from 9 to 30% of the sample increment cores between 14 and 16 years. A similar increase from 13 to 27% was noted with the Patox washer treatments, which demonstrated little efficacy over the test period (**Table II-1**). As noted in previous reports, the poor performance of this system did not reflect a lack of toxicity, but rather an inability of the chemical to move into the bolt hole at levels that would convey protection. Poles with bolt holes treated with Boracol 40 also experienced an increased level of fungal colonization, but the increase was relatively small (1 % increase between year 14 and 16), suggesting that the treatment was still

effective. Fungal colonization in poles with bolt holes treated with either ammonium bifluoride or polybor continue to experience low levels of fungal colonization, perhaps reflecting the ability of these treatments to diffuse inward from the point of application to protect small checks that open as the wood weathers and ages. While both boron and fluoride are mobile and should eventually diffuse from the bolt hole, it is apparent that either the rate of chemical loss or the rate of fungal invasion is slow. In either case, the poles receiving these two treatments continue to experience little or no fungal colonization in the area near the field drilled bolt holes. We will continue to monitor these poles on a biennial basis to determine when the treatment fails to protect the wood.

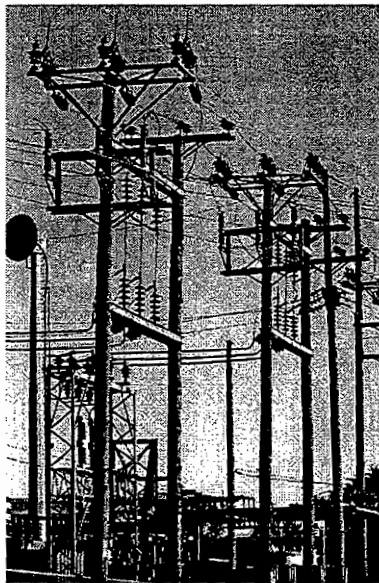

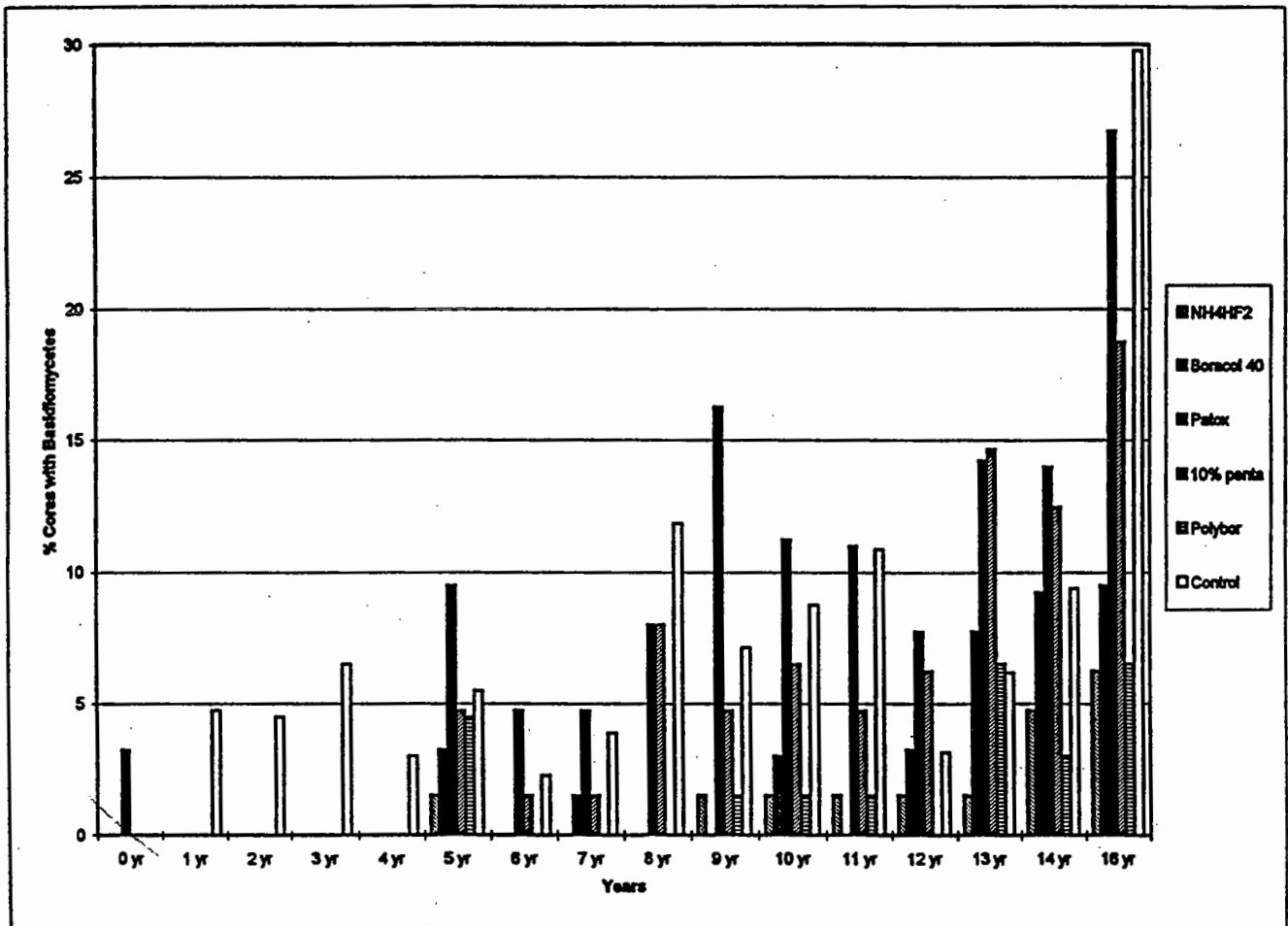

Figure II-1. Percentage of basidiomycete colonized increment cores removed from Douglas-fir poles at various times after application of preservative treatments to field drilled bolt holes.

Table II-1. Percentage of basidiomycete-colonized increment cores removed from Douglas-fir poles at various times after application of preservative treatments to field-drilled bolt holes.

Treatment	n	Fungal Colonization (%) a																
		0 yr	1 yr	2 yr	3 yr	4 yr	5 yr	6 yr	7 yr	8 yr	9 yr	10 yr	11 yr	12 yr	13 yr	14 yr	16 yr	
NH <sub>4</sub> HF <sub>2</sub>	32	0 <sup>41</sup>	-	-	-	-	-	2 <sup>17</sup>	0 <sup>5</sup>	0 <sup>18</sup>	0 <sup>18</sup>	2 <sup>44</sup>	2 <sup>9</sup>	2 <sup>47</sup>	2 <sup>39</sup>	2 <sup>39</sup>	5 <sup>39</sup>	6 <sup>35</sup>
Boracol 40	32	0 <sup>57</sup>	-	-	-	-	-	3 <sup>44</sup>	0 <sup>19</sup>	2 <sup>48</sup>	0 <sup>33</sup>	0 <sup>64</sup>	3 <sup>16</sup>	0 <sup>71</sup>	3 <sup>42</sup>	8 <sup>60</sup>	9 <sup>60</sup>	10 <sup>57</sup>
Patox	32	3 <sup>60</sup>	-	-	-	-	-	10 <sup>41</sup>	5 <sup>13</sup>	5 <sup>22</sup>	8 <sup>31</sup>	16 <sup>67</sup>	11 <sup>39</sup>	11 <sup>55</sup>	8 <sup>48</sup>	14 <sup>49</sup>	14 <sup>55</sup>	27 <sup>71</sup>
10% Penta	32	0 <sup>44</sup>	-	-	-	-	-	5 <sup>56</sup>	2 <sup>25</sup>	2 <sup>18</sup>	8 <sup>31</sup>	5 <sup>53</sup>	7 <sup>25</sup>	5 <sup>80</sup>	6 <sup>61</sup>	15 <sup>67</sup>	13 <sup>64</sup>	19 <sup>70</sup>
Polybor	32	0 <sup>38</sup>	-	-	-	-	-	5 <sup>27</sup>	0 <sup>11</sup>	0 <sup>25</sup>	0 <sup>28</sup>	2 <sup>38</sup>	2 <sup>14</sup>	2 <sup>75</sup>	0 <sup>40</sup>	7 <sup>60</sup>	3 <sup>69</sup>	7 <sup>46</sup>
Control	64	0 <sup>63</sup>	5 <sup>8</sup>	5 <sup>10</sup>	7 <sup>35</sup>	3 <sup>99</sup>	6 <sup>55</sup>	2 <sup>32</sup>	4 <sup>33</sup>	12 <sup>53</sup>	7 <sup>66</sup>	9 <sup>35</sup>	11 <sup>66</sup>	3 <sup>56</sup>	6 <sup>61</sup>	9 <sup>68</sup>	30 <sup>77</sup>	

a Numbers represent percentage of cores that contained basidiomycetes. Superscripts denote levels of non-decay fungi.

## B. USE OF SMALL SCALE BIOASSAYS FOR EVALUATING PROTECTION OF FIELD DRILLED BOLT HOLES IN RED OAK, YELLOW POPLAR, LOBLOLLY PINE AND DOUGLAS-FIR.

Wood preservatives provide excellent barriers against degradation by fungi, insects, and other agents, but performance can be sharply influenced by the integrity of this barrier (Graham, 1983). Although most specifications recommend that all cuts, bore holes, or other fabrication be performed before preservative treatment (AWPA, 1996), later fabrications in the field can compromise this treatment barrier. This is particularly true in timber bridges, when members are cut to fit in decks, spikes are driven to attach decking, or holes are drilled to attach railings and other fixtures. Untreated wood can then be exposed, diminishing the benefits of preservative treatment and creating the potential for internal deterioration.

Standard M1 of the American Wood Preservers' Association recommends that all cuts or other damage to the treated shell be supplementally treated with preservative solution.

Often, however, these treatments are omitted because the workers dislike the oily nature of those chemicals. In addition, the applicator must be certified to apply pesticides because some topical treatments have restricted use classifications. It is highly unlikely that fabrication damage will be treated because it is generally difficult to inspect a bridge to ensure that these treatments have indeed been performed.

Failure to treat field cuts and bore holes can sharply reduce service life and increase long-term maintenance costs of treated wood. Alternative, easy-to-apply treatments are needed to protect field-damaged wood from degradation. Unfortunately, lengthy field tests are needed to identify materials that will inhibit the development of decay. Morrell et al. (1990) showed that more than 10 years were required to adequately test treatments of field-drilled bolt holes in Douglas-fir poles. Given the time constraints of field trials, we chose a laboratory assessment of the efficacy of selected chemicals on wood species used in timber bridge construction.

Table II-2: Treatments applied to conifer and hardwood blocks.

Chemical	Concentration	Carrier	Supplier
Sodium octaborate tetrahydrate (DOT)	10.0%	water	U.S. Borax, Valencia, CA
Sodium fluoride (NaF)	10.0%	water	Osmose Wood Preserving, Buffalo, N.Y.
Copper-8-quinolinate (Cu-8)	0.5% (as Cu)	oil	Morton Chemical Intl., Andover, MA
Copper naphthenate	2.0% (as Cu)	oil	OMG Inc., Cleveland, OH
Pentachlorophenol (Penta)	10.0%	oil	ISK Biosciences, Memphis, TN

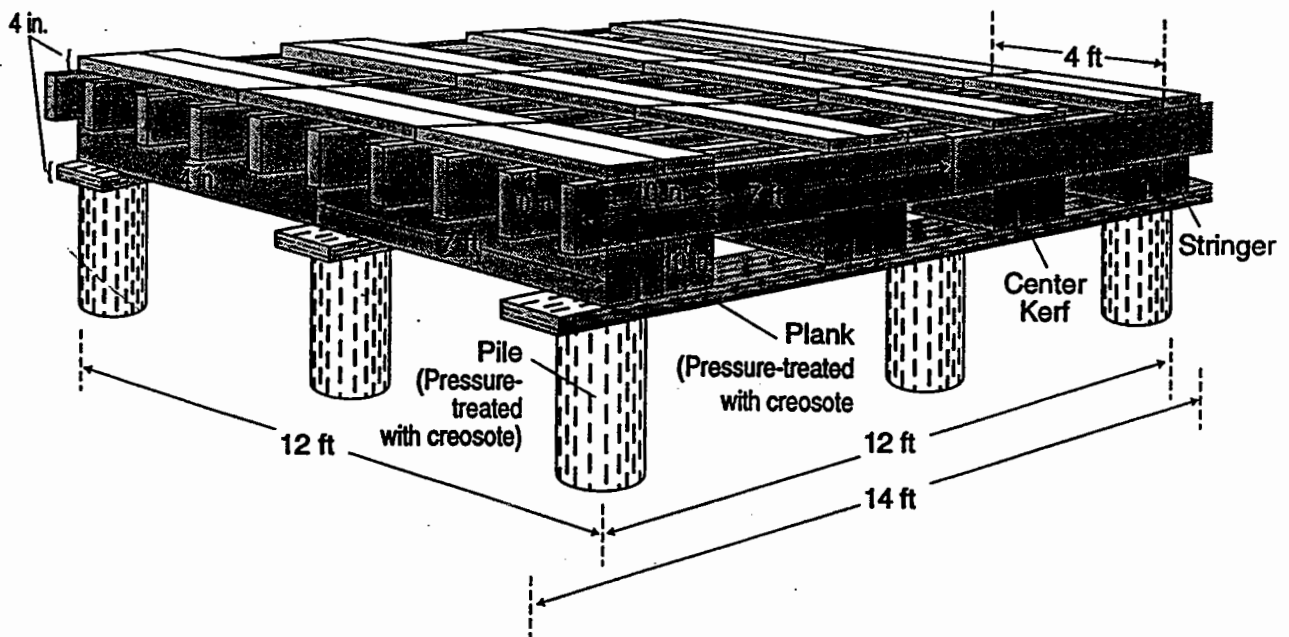

Figure II-2: Simulated pier structures used to evaluate remedial treatments for preventing fungal decay.

The simplest approach is to measure weight loss in blocks treated with the desired chemical and exposed to a decay fungus, but the large size of the test blocks needed to realistically assess topical treatments may mask poor performers (Newbill and Morrell, 1992). Instead, we evaluated the ability of the test fungus to penetrate the surface chemical barrier and become established within the test block.

Straight-grained, defect-free dimension lumber of red oak (*Quercus rubra* L.), yellow-poplar (*Liriodendron tulipifera* L.), loblolly pine (*Pinus taeda* L.), and Douglas-fir (*Pseudotsuga menziesii* (Mirb.) Franco) was cut into blocks 25 by 50 by 38 mm long. One 10-mm-diameter bolt hole was drilled through each block at the center of the wide face. The blocks were then cut in half through the hole. Matched block halves were labeled, secured with a rubber band, and dip-treated with selected fungicides or water to simulate treatment of a field-drilled bolt hole (Table II-2). The blocks were then weathered for zero, two, four, or eight weeks to monitor leaching. Weathering consisted of 0, 14, 28, or 56 cycles, respectively, of soaking the blocks in an excess of water for eight hours; then oven-drying them overnight at 56°C. The blocks were then pressure-soaked with water, placed in a tray, and steamed for 1 hour at 110°C to eliminate contaminants.

The blocks were then exposed to the test fungus *Gloeophyllum trabeum* ((Pers.:Fr., Murrill); Isolate #ATCC 11539) by modifying a procedure from Sexton et al. (1994). The inoculum was prepared by cutting a 3-mm-diameter plug from the edge of an actively growing culture of the test fungus on 1 percent malt extract agar (MEA). The plug was incubated in 50 ml of 1.5 percent malt extract broth for 14 to 21 days. Afterward, the mycelial growth was filtered and rinsed three times with sterile distilled water (H<sub>2</sub>O), then washed into a sterile container and diluted with 100 ml sterile H<sub>2</sub>O.

The resulting inoculum suspension was briefly mixed in a blender. Inoculum viability and purity were confirmed by placing an aliquot on an MEA plate and observing regrowth of the test fungus and contaminants. Approximately 180 g of dry vermiculite and 700 ml of H<sub>2</sub>O were

added to plastic bags, each with a breathable air patch. Sixteen bags per inoculation were loosely sealed and autoclaved for 25 minutes at 121°C. The blocks were inoculated with the test fungus by injecting 200  $\mu$ l of the mycelial suspension in sterile dH<sub>2</sub>O into each bolt hole.

A sterile, galvanized bolt was placed in each hole, a sterile nut was attached, and the assembled block was placed in the sterile vermiculite. The bags were sealed and incubated at 28°C for two, four, six, or eight weeks. At each time point, five blocks from each treatment were removed. A series of four 5-mm-thick sections were cut from each side of the bolt hole. Each section was cut into four cubes, which were plated on 1.5 percent MEA and observed over 30 days for growth of the test fungus to measure chemical efficacy.

Topical preservatives can be excellent barriers against fungal attack, but many of our treatments were susceptible to leaching (Tables II-3). While biocide mobility may be advantageous when the biocide can move to the point of fungal attack, this is eventually detrimental because such materials are more likely to be depleted in these areas. This is a particular problem with bolt hole treatments because it is difficult to retreat the damaged wood.

Fungal colonization in untreated control blocks generally increased with extended incubation periods (Tables II-3 to 6). As expected, colonization was initially greatest adjacent to the bolt hole, but this concentration declined with increasing incubation period. Fungal colonization was most rapid in untreated yellow-poplar, followed by red oak, loblolly pine, and Douglas-fir. These differences reflect the relative natural resistance of these woods to fungal attack (Scheffer and Cowling, 1966). Leaching variably affected colonization on untreated control blocks. In some instances, blocks exposed for two weeks of leaching were colonized to a greater extent than were nonleached blocks. This was most noticeable with Douglas-fir. Leaching for an additional two weeks negatively affected colonization. Soluble sugars may have been lost during the prolonged leaching, making the wood less suitable for colonization.

Table II-3. Percent fungal colonization<sup>a</sup> in red oak as a function of weathering and incubation periods, and distance from drilled bolt holes.

Chemical Treatment	Weathering Period (weeks)	Incubation period/Distance from drilled bolt hole (mm)																							
		2 weeks						4 weeks						6 weeks						8 weeks					
		0-5	5-10	10-15	15-20	0-5	5-10	10-15	15-20	0-5	5-10	10-15	15-20	0-5	5-10	10-15	15-20	0-5	5-10	10-15	15-20				
None(a)	0	40	8	10	0	45	33	15	18	98	85	90	90	100	100	100	100	100	100	100	100				
	2	53	48	28	10	78	95	95	83	98	100	100	98	100	100	100	98	100	98	95	100				
	4	0	0	0	0	40	28	38	15	98	95	83	68	100	100	100	100	100	100	100	100				
Boron	0	0	0	0	0	43	8	0	0	0	0	0	0	0	0	0	0	0	0	0	0				
	2	15	0	0	5	58	48	38	40	98	100	98	93	100	100	100	100	100	100	100	100				
	4	65	60	60	58	100	100	100	100	100	100	100	100	100	100	100	100	100	100	100	98				
Cu+8	8	83	63	20	25	80	80	75	75	85	85	90	90	90	90	100	100	100	100	100	100				
	0	0	0	0	0	0	0	0	0	0	0	0	0	0	0	0	0	0	0	0	0				
	2	0	0	0	0	0	0	0	0	0	0	0	0	0	0	0	0	0	0	0	0				
	4	0	0	0	0	0	0	0	0	0	0	0	0	0	0	0	0	0	0	0	0				
	8	0	0	0	0	0	0	0	0	0	0	0	0	0	0	0	0	0	0	0	0				
Copper Naphthenate	0	0	0	0	0	35	5	0	0	50	30	20	0	35	5	0	0	5	0	0	0				
	2	20	0	0	0	10	0	0	0	10	0	0	0	0	0	0	0	50	50	50	10				
	4	25	10	8	5	58	48	38	30	75	75	70	60	90	80	80	73	65	65	65	65				
	8	0	10	0	0	30	30	30	30	60	60	55	55	90	90	100	100	100	100	100	100				
NaF	0	40	110	0	0	30	20	0	0	100	100	65	50	100	100	100	100	100	100	100	90				
	2	30	10	0	0	88	65	40	30	100	100	90	85	98	100	95	100	100	100	100	100				
	4	55	48	35	35	75	70	60	43	100	95	85	65	83	85	85	83	85	85	85	83				
	8	83	70	60	45	93	93	90	70	85	78	100	100	100	100	100	100	100	100	100	98				
Penta	0	0	0	0	0	0	0	0	0	0	0	0	0	0	0	0	0	0	0	0	0				
	2	0	0	0	0	20	0	0	0	40	35	5	0	45	40	5	0	40	40	40	0				
	4	25	0	0	0	35	15	5	0	35	25	0	0	45	40	15	5	40	40	40	0				
	8	5	0	0	0	30	25	0	0	50	40	10	10	75	60	50	40	60	60	60	40				

a Values reflect percent recovery from 40 samples removed from treatment holes of 5 blocks.  
b Blocks weathered for eight weeks were lost to contamination.



TABLE II-4. Percent fungal colonization\* in yellow-poplar as a function of weathering and incubation periods, and distance from drilled bolt holes.

Chemical Treatment	Weathering period (weeks)	Incubation period/Distance from drilled bolt hole (mm)																	
		2 weeks						4 weeks						8 weeks					
		0-5	5-10	10-15	15-20	0-5	5-10	10-15	15-20	0-5	5-10	10-15	15-20	0-5	5-10	10-15	15-20		
None <sup>a</sup>	0	73	18	0	0	68	65	33	28	100	100	100	100	100	100	100	100	100	100
	2	83	70	60	35	65	70	75	65	93	65	75	65	85	100	98	75	98	100
	4	0	0	0	0	88	70	53	40	100	100	100	100	100	100	100	100	100	100
Boron	0	0	0	0	0	0	0	0	0	45	25	10	0	0	70	50	10	50	15
	2	63	40	20	0	50	48	35	38	100	95	93	93	100	100	100	100	100	100
	4	100	100	90	65	100	100	100	100	100	95	93	83	100	100	100	100	100	100
Cu-8	8	78	68	50	40	78	70	60	65	65	65	75	75	95	95	90	90	90	90
	0	0	0	0	0	0	0	0	0	0	0	0	0	0	0	0	0	0	0
	2	0	0	0	0	0	0	0	0	0	0	0	0	0	0	0	0	0	0
	4	0	0	0	0	0	0	0	0	0	0	0	0	0	0	0	0	0	0
Copper naphthenate	0	0	0	0	0	0	0	0	0	10	0	0	0	0	30	0	0	0	0
	2	0	0	0	0	10	0	0	0	10	0	0	0	0	18	10	0	0	0
	4	30	20	10	0	65	55	43	25	93	78	70	58	100	100	100	100	100	98
	8	20	10	0	0	50	50	25	20	50	55	30	30	80	80	70	70	70	70
NaF	0	40	10	0	0	100	90	65	40	100	100	95	75	100	100	100	100	100	70
	2	70	48	40	23	98	90	78	58	100	100	95	85	90	90	90	90	90	85
	4	78	65	55	43	85	78	70	55	100	98	83	85	95	90	90	90	90	90
	8	100	70	55	20	90	90	75	78	90	73	58	40	100	100	100	100	100	98
Penta	0	0	0	0	0	0	0	0	0	25	15	0	0	0	10	0	0	0	0
	2	0	0	0	0	15	5	0	0	40	30	25	10	45	40	20	20	20	20
	4	15	5	0	0	28	10	0	0	35	25	0	0	60	60	50	40	40	40
	8	18	0	0	0	50	40	25	13	65	65	35	30	95	85	83	80	80	80

a Values reflect % recovery from 40 samples removed from treatment holes of 5 blocks.

b Blocks weathered for eight weeks were lost to contamination.

**TABLE 11-5 — % Fungal colonization<sup>a</sup> in loblolly pine as a function of weathering and incubation periods, and distance from drilled bolt holes.**

Chemical treatment	Weathering period (weeks)	Incubation period/Distance from drilled bolt hole (mm)															
		2 weeks				4 weeks				8 weeks							
		0-5	5-10	10-15	15-20	0-5	5-10	10-15	15-20	0-5	5-10	10-15	15-20				
None <sup>b</sup>	0	13	10	10	0	0	0	0	0	90	88	88	75	80	80	75	70
	2	20	25	25	20	15	10	5	8	65	60	60	53	83	85	73	73
	4	0	0	0	0	0	0	0	0	68	43	45	30	100	83	60	55
Boron	0	0	0	0	0	0	0	0	0	0	0	0	0	0	0	0	0
	2	0	0	0	0	0	0	0	0	0	0	0	0	0	0	0	0
	4	100	100	83	70	100	100	100	100	100	100	100	88	100	100	100	100
Cu-8	0	83	10	85	65	88	83	98	85	85	85	80	80	75	75	100	100
	2	0	0	0	0	0	0	0	0	0	0	0	0	0	0	0	0
	4	0	0	0	0	0	0	0	0	0	0	0	0	0	0	0	0
	8	0	0	0	0	0	0	0	0	0	0	0	0	0	0	0	0
Copper naphthenate	0	10	0	0	0	15	0	0	0	15	0	0	0	15	0	0	0
	2	40	0	0	0	15	0	0	0	10	0	0	0	20	15	0	0
	4	45	25	3	0	90	80	65	50	83	90	80	70	100	100	100	90
	8	15	5	0	0	55	55	50	50	50	50	50	50	80	80	80	80
NaF	0	0	0	0	0	0	0	0	0	0	0	0	0	0	0	0	0
	2	90	70	65	63	88	80	83	80	100	100	100	95	100	100	100	83
	4	98	65	80	80	100	100	100	88	100	100	100	90	100	100	100	100
	8	100	85	68	60	100	98	88	83	95	95	95	100	100	100	100	100
Penta	0	10	0	0	0	8	0	0	0	15	10	0	0	10	0	0	0
	2	0	0	0	0	15	0	0	0	35	25	10	5	45	35	5	0
	4	20	5	0	0	10	5	0	0	30	10	0	0	40	30	15	15
	8	10	0	0	0	40	35	0	0	50	50	20	5	60	50	48	25

<sup>a</sup> Values reflect % recovery from 40 samples removed from treatment holes of 5 blocks.

<sup>b</sup> Blocks weathered for eight weeks were lost to contamination.

TABLE II-6 - % Fungal colonization in Douglas-fir as a function of weathering and incubation periods, and distance from drilled bolt holes.

Chemical Treatment	Weathering period (weeks)	Incubation period/Distance from drilled bolt hole (mm)															
		2 weeks			4 weeks			6 weeks			8 weeks						
		0-5	5-10	10-15	15-20	0-5	5-10	10-15	15-20	0-5	5-10	10-15	15-20	0-5	5-10	10-15	15-20
None <sup>a</sup>	0	0	0	0	0	0	0	0	0	0	0	0	0	0	0	0	0
	2	0	0	0	0	18	10	5	0	78	70	80	60	73	65	55	50
	4	0	0	0	0	0	0	0	0	73	60	55	35	85	83	55	50
	8	0	0	0	0	0	0	0	0	0	0	0	0	100	98	70	55
Boron	0	0	0	0	0	0	0	0	0	0	0	0	0	0	0	0	0
	2	0	0	0	0	0	0	0	0	0	0	0	0	0	0	0	0
	4	0	0	0	0	0	0	0	0	0	0	0	0	0	0	0	0
	8	20	10	0	0	45	30	25	20	45	35	35	18	65	60	55	60
Cu-3	0	0	0	0	0	0	0	0	0	0	0	0	0	0	0	0	0
	2	0	0	0	0	0	0	0	0	0	0	0	0	0	0	0	0
	4	0	0	0	0	0	0	0	0	0	0	0	0	0	0	0	0
	8	0	0	0	0	0	0	0	0	0	0	0	0	0	0	0	0
Copper naphthenate	0	0	0	0	0	0	0	0	0	0	0	0	0	50	10	0	0
	2	0	0	0	0	0	0	0	0	0	0	0	0	10	5	0	0
	4	5	0	0	0	10	0	0	0	33	28	10	10	43	25	5	3
	8	0	0	0	0	20	20	5	0	30	20	15	10	50	50	65	50
NaF	0	0	0	0	0	10	0	0	0	0	0	0	0	0	0	0	0
	2	0	0	0	0	6	0	0	0	30	30	20	5	80	70	60	45
	4	20	15	5	3	28	25	15	5	85	80	60	45	80	75	50	50
	8	8	0	0	0	43	20	10	5	28	13	8	5	45	40	5	0
Pentla	0	0	0	0	0	0	0	0	0	5	0	0	0	10	0	0	0
	2	0	0	0	0	0	0	0	0	25	15	10	8	35	20	5	0
	4	5	0	0	0	5	0	0	0	15	6	0	0	30	20	0	0
	8	0	0	0	0	13	0	0	0	35	13	0	0	35	20	3	0

<sup>a</sup> Values reflect % recovery from 40 samples removed from treatment holes of 5 blocks.

<sup>b</sup> Blocks weathered for eight weeks lost to contamination.

Topically treating the test blocks dramatically increased *Gloeophyllum trabeum* colonization in all of the species. This effect was most pronounced for pine and Douglas-fir, but was also noticeable in the hardwoods. Of the five chemicals evaluated, only Copper-8 inhibited colonization for the entire eight-week incubation period in all species.

The sodium octaborate tetrahydrate (boron) treatment provided an effective barrier for Douglas-fir and pine blocks leached no more than two weeks. In nonleached blocks both penta- and copper naphthenate-treated bolt holes were colonized to varying degrees by the test fungus. Copper naphthenate has largely replaced penta as the preferred treatment for protecting treated wood. Both, however, had some colonization on nonleached blocks within four weeks of incubation on red oak and loblolly pine. This colonization generally did not extend beyond 10 mm from the treated surface for the first six weeks; these treatments probably would fail eventually. Field trials with penta-treated field-drilled bolt holes have shown similar results (Morrell et al., 1990).

Sodium fluoride provided the poorest protection for all species. The test fungus was isolated at all four depths from nonleached blocks of three out of four species. This chemical appeared to be effective only on Douglas-fir heartwood blocks. Heartwood was evaluated only in Douglas-fir; it is likely that the combination of the moderately durable heartwood and sodium fluoride provided enhanced protection.

Leaching was extremely detrimental to the protective chemical effects. As expected, water-soluble chemicals were far more sensitive to leaching exposure. Boron-treated red oak and yellow-poplar blocks that were leached for two weeks were rapidly colonized. Boron appeared to leach more slowly from the two conifers. Colonization was not evident in boron-treated pine blocks leached for two weeks, whereas similarly treated Douglas-fir was colonized only after eight weeks of incubation. After two more weeks the value of topical treatment was largely negated in all four species.

The sensitivity of boron-based biocides to leaching loss is well documented (Lloyd, 1997)

and is confirmed by our results with these small blocks. The significance of leaching on a bolt hole is difficult to determine. A fastener is typically driven into a slightly under-drilled hole so that the amount of moisture moving along the fastener and into the untreated wood exposed during fabrication may be negligible. Newbill and Morrell (1992) showed that boron sprays protected field-drilled bolt holes in Douglas-fir poles exposed for over 10 years in western Oregon. Thus, the bolt hole environment may be less susceptible to leaching.

Leaching of sodium fluoride-treated bolt holes also lowered the resistance to fungal colonization, regardless of the wood species. As with boron, leaching of fluoride from pine and Douglas-fir was initially slower than from either hardwood. Douglas-fir appeared to be somewhat more resistant to colonization after leaching, evidence of some residual fluoride.

All three oil-borne formulations were less sensitive to leaching exposure. Copper-8 was by far the most leach-resistant chemical. This was demonstrated by the absence of the test fungus from all blocks regardless of the length of either the leaching or the incubation periods. Leaching of copper naphthenate-treated blocks resulted in higher levels of fungal colonization as leaching time or incubation increased. Fungal colonization was greatest in copper naphthenate-treated pine leached for four weeks and incubated for six weeks. The two hardwood species had lower but similar levels of colonization. Again, Douglas-fir was somewhat more resistant to colonization even after the extended leaching period.

Penta performance was similar to that of copper naphthenate, showing increasing degrees of colonization with prolonged leaching and incubation. Morrell et al. (5) found that neither penta nor copper naphthenate migrated more than 10 mm from a highly concentrated paste into Douglas-fir sapwood. Relatively small amounts of concentrated biocide are applied to the wood surface in bolt-hole treatments. Therefore, little chemical is available to diffuse more deeply into the wood. This is particularly critical when oil-borne materials are unable to migrate farther as splits or checks develop. Water-soluble treatments can move along

developing checks or splits so that newly exposed wood is less susceptible to fungal attack.

Copper-8 is an excellent fungicide but its enhanced performance compared with copper naphthenate or penta was unexpected. This may reflect the excellent biocidal properties of both the copper and quinoline components. Naphthenic acid lacks the biocidal properties of quinoline (Hartford, 1973), and *G. trabeum* is tolerant to pentachlorophenol (Zabel and Morrell, 1992). However, biocidal efficacy does not completely explain the better performance of Copper-8. Clearly, this chemical also resisted leaching to a greater extent than did either penta or copper naphthenate.

In drier climates or in situations where tight-fitting fasteners are used, boron or Copper-8 provides the best protection against fungal colonization. Where the leaching risk is higher, Copper-8 is clearly more effective than the other four chemicals we evaluated. Treatments were most effective in Douglas-fir heartwood, followed by loblolly pine. Protection was generally lower for red oak and yellow-poplar. Field fabrication of bridges constructed from these hardwood species may pose special challenges in decay prevention.

### **C. EVALUATION OF TOPICAL TREATMENTS FOR PROTECTING UNTREATED DOUGLAS-FIR TIMBERS**

The moderate durability of Douglas-fir heartwood has encouraged the use of that species without conventional pressure treatment in non-soil exposures (5). Wood that is pressure treated with chemicals in accordance with the standards of the American Wood-Preservers' Association will have a longer, more reliable service life (1996), but many ports and marinas along the Pacific Northwest Coast use untreated wood because of limited budgets. The untreated Douglas-fir will eventually decay, a process that can create considerable liability for ports. The methods for limiting decay progression in large timbers include application of surface-applied preservatives and kerfing before installation (Graham, 1983; Graham and Estep, 1966; Helsing and Graham, 1976; Helsing et al., 1984; Highley, 1980, 1983, 1984; Highley and

Scheffer, 1975, 1978). Unfortunately, few long-term tests have been undertaken to demonstrate the efficacy of these treatments on western wood species. In a previous report, we described the results of one such trial of topical fungicides on kerfed and non-kerfed Douglas-fir timbers over a 6-year period (Morrell et al., 1987). This report describes the results of that trial after an additional 10 years of exposure.

The structures used for the evaluation were designed to create various combinations of exposed end-grain and butt joints that would serve as water-collection points and encourage decay development (Morrell et al., 1987). Briefly, five simulated piers were constructed in an open field near Corvallis, Oregon. Each pier was supported by nine creosoted piles that were equally spaced in a 3.6-m square area. A 50-mm by 300-mm by 2.1-m plank was placed across each of three groups of piles to provide support for the caps. Each pier was constructed with 8 pairs of abutting 250-mm by 250-mm by 2.1-m caps, 10 pairs of abutting 100-mm by 250-mm by 2.1-m stringers, and 8 trios of abutting 100-mm by 250-mm by 1.6-m deck planks (**Figure II-2**). A kerf was sawn to the center of the timber along the length on one face of each of eight caps. The kerfs were oriented downward in the completed piers to prevent water collection. The remaining eight caps were not kerfed.

The five structures were used to evaluate nine different treatment combinations of wood and roofing felt (**Table II-7**). Each treatment was applied to the upper surfaces of the caps, stringers, deck planks of one half of a structure. The remaining untreated half deck served as a control. Each treatment was evaluated on 4 caps, 10 stringers and 4 sets of abutting deck boards. The decking, laid over roofing felt, received a supplemental treatment of either 3.5 liters of fluor-chrome-arsenic-phenol (FCAP), ammonium bifluoride (ABF), or disodium octaboratetetrahydrate (DOT), each sprayed over the top surface, into seasoning checks, and into the butt joints of the deck planks 2 years after installation.

The resistance to fungal attack of the various surface treatments of the wood was assessed by

Table II-7.—Surface treatments of wood members and roofing-felt treatments<sup>a</sup> used in five simulated piers

Treatment and Felt Type	Carried	Concentration (%)
Pentachlorophenol (penta)	oil	10
Copper-8-quinolinolate	oil	1 (Cu basis)
Fluor-chrome-arsenic-phenol (FCAP) (as a slurry)	water	12
Ammonium bifluoride (ABF)	water	20
Timbor® (DOT)	water	9
FCAP-flooded felt	water	2
ABF-flooded felt	water	20
DOT-flooded felt	water	-9
Roofing felt alone	water	--

a. Felt was applied beneath the stringers and beneath the decking planks.



removing increment cores and placing them on 1-percent malt extract agar in petri dishes. At each sampling the wood and agar were observed over a 30-day period for evidence of fungal growth, and any fungal growth was examined for characteristics typical of basidiomycetes, a class of fungi containing important wood degraders. Two cores were removed from the underside of each cap adjacent to the creosote support planks, one from each end. Four cores were removed from every fourth stringer on a rotating basis so that each stringer was evaluated every fourth year: two from the stringer directly under the overlaying deck plank and two at the stringer/cap junction.

The decking was sampled at the junction of abutting deck boards, at the deck and stringer junction, and at mid-span between two stringers. One core was removed from one location on each deck at each sampling point, rotating locations so that each board had been sampled at all three locations after three sampling times.

The levels of decay fungi in all of the members varied over time with position and the supplemental chemical applied. Fungal colonization tended to increase with time in all treatments, suggesting that the protective level of supplemental treatments declined over time below the threshold for fungal attack.

The levels of decay fungi in the caps varied widely with both the chemical treatment and the presence or absence of kerfs (**Table II-8**). Kerfed caps were generally associated with lower levels of basidiomycetes, particularly over the first 6 years of the test, the exception being the penta treatment after 1 year, in which the kerfed caps had higher basidiomycete levels. The reason for the differences are unclear, although they may reflect fungi present at the time of installation rather than colonization through checks in the wood. Fungal levels in penta-treated wood removed 4, 6, or 13 years after installation were generally lower in kerfed samples. Kerfing should reduce the development of deep checks that serve as moisture reservoirs in the larger timbers (Graham, 1983); such sites provide stable temperature and humidity for the growth of decay fungi. Kerfed caps had relatively few large, deep checks, even 16 years after installation,

while checking in non-kerfed caps was more variable.

Supplemental treatments to the caps reduced the incidence of decay in most treatments. Application of the water-soluble ABF or FCAP was associated with far lower levels of fungal attack. Application of DOT provided slightly lower levels of protection, suggesting either that the boron in this formulation was susceptible to leaching or that inadequate levels of chemical were initially applied. Both boron and fluoride have been previously shown to move through Douglas-fir heartwood and should protect against fungal attack (Lebow and Morrell, 1989; Morrell et al., 1989).

Copper-8-quinolinolate, an oil-soluble chemical, also performed well earlier in the kerfed caps. Penta provided relatively little protection, a disturbing finding in light of the decades-long recommendation for use of that chemical to protect wood damaged during installation (AWPA, 1996). The reason for the differential performance of penta and copper-8-quinolinolate is unclear; both are presumed to be chemicals that do not move appreciable distances into the wood from the point of application. The declining protection noted between 6 and 13 years with virtually all treatments suggests that fungal invasion of the caps might have been prevented by another supplemental treatment in that time interval.

The use of roofing felt to shield the caps and to provide a base for chemical appeared to reduce the incidence of decay fungi. With roofing felt alone, levels of fungal isolation were lower than in the untreated control, and the presence of a saw kerf appeared to improve the protective effect over the first 6 years. Results with the addition of either FCAP or DOT were more variable, although with both treatments protection increased in comparison to the control.

Basidiomycete levels in the decking and stringers varied widely over the 16-year exposure (**Table II-9**). In general, those treated with water-soluble ABF and FCAP contained lower levels of fungi than those treated with penta or DOT. The combination of DOT and felt again performed better than DOT alone. Copper-8-quinolinolate

Table II-8. The percentage of basidiomycete-containing increment cores taken at intervals after initial treatment of kerfed and nonkerfed Douglas-fir caps in five simulated piers.

Treatment	1 year		4 years		6 years		13 years		16 years		18 years	
	Kerfed	Nonkerfed	Kerfed	Nonkerfed	Kerfed	Nonkerfed	Kerfed	Nonkerfed	Kerfed	Nonkerfed	Kerfed	Nonkerfed
Pentachlorophenol	25	0	25	37	13	50	38	75	75	50	50	63
Copper-8-quinolinolate	0	25	0	37	0	13	25	75	25	25	50	25
FCAP	0	0	0	0	13	0	13	13	0	0	13	13
ABF	0	0	0	0	0	0	25	13	25	13	0	0
DOT	0	13	25	37	50	50	25	38	13	50	63	63
FCAP	0	0	0	0	25	13	0	0	0	13	13	13
DOT-flooded felt	0	0	0	0	0	13	13	0	13	13	13	0
Felt alone	0	0	0	0	0	13	25	13	25	13	25	13
Control	0	0	13	50	25	88	25	38	50	50	38	38



Table II-9. The percentage of basidiomycete-containing increment cores taken 2 to 18 years after initial treatment of Douglas-fir decking near water-trapping joints in five simulated piers.<sup>a</sup>

Treatment	Fungal Colonization (%)																	
	Butt Joint						Decking/Stringer Junction						Decking Midspan					
	2 yr	6 yr	13 yr	16 yr	18 yr		2 yr	6 yr	13 yr	16 yr	18 yr		2 yr	6 yr	13 yr	16 yr	18 yr	
Pentachlorophenol	25	0	0	25	25		0	25	75	40	75		0	0	75	33	50	
Copper-8-quinolinolate	0	25	0	0	75		0	25	0	0	75		0	25	0	25	100	
FCAP	0	25	0	0	0		0	50	25	25	20		0	50	25	0	33	
ABF	0	0	0	0	0		0	25	0	25	25		0	25	0	0	0	
DOT	0	50	25	25	0		0	75	50	25	33		0	0	0	75	25	
FCAP-flooded felt (b,c)	0	0	0	0	0		0	0	0	0	0		0	25	0	0	0	
ABF-flooded felt (b,c)	0	25	0	0	33		0	0	0	0	0		0	0	0	33	20	
DOT-flooded felt (b,c)	0	0	0	0	20		0	25	25	0	33		0	25	25	33	25	
Felt alone (b)	25	50	25	25	0		0	25	25	25	40		25	50	50	50	67	
Control	25	25	0	0	33		0	25	50	50	0		0	50	25	25	20	

<sup>a</sup> One core was removed annually from each of 12 decking planks (butt joint, decking/stringer junction, or decking midspan) until all areas were sampled in each plank.

<sup>b</sup> Felt was applied between decking and stringer and stringer and cap.

<sup>c</sup> After 2 years, a second treatment was applied.

also provided good protection for stringers for the first 13 years, but roofing felt without supplemental chemicals provided little or no protection. It is possible that the felt served to trap moisture at the junctions.

Fungal colonization in the decking followed similar trends to those found for the stringers, although the performance of some treatments was even more variable. For example, FCAP performed sporadically in the decking, as did copper-8-quinolinolate. Decking is generally exposed to more frequent wetting and wet/dry cycles. As a result, chemical protection might diminish more rapidly because of leaching in decking members.

Decay in most large timbers is believed to be enhanced by water-trapping joints (Helsing and Graham, 1976), but the levels of basidiomycete colonization did not always reflect the presence of such joints (Table II-10). For example, fungal colonization in untreated decking at the decking

and stringer junction was similar to that in samples removed from the mid-span of the boards. A similar trend was noted for decking with untreated felt. Fungal colonization was generally low at all locations in decking receiving FCAP or ABF alone or on felt. Once again, colonization in DOT-treated samples was near that of the control when the felt was not included. While fungi continue to be isolated from the decks, advanced decay in the treated decking remains minimal. Brown rot attack has been noted around checks in the untreated control decking.

The application of preservatives to untreated Douglas-fir timbers at the time of construction appears to decrease levels of fungal colonization. The protective effect apparently declines with time, and re-application to supplement the original protection may be advisable.

Table II-10. The percentage of basidiomycetes-containing increment cores taken at 1 to 18 years after initial treatment of Douglas-fir stringers and decking in five simulated piers.

Treatment	Fungal Colonization (%)										
	Stringers					Decking					
	1 yr	4 yr	6 yr	13 yr	18 yr	1 yr	4 yr	6 yr	13 yr	16 yr	18 yr
Pentachlorophenol	30	20	25	30	47	0	25	8	30	33	50
Copper-8-quinolinolate	5	5	5	5	40	0	17	25	0	8	83
FCAP	0	10	0	5	20	0	8	42	17	8	17
ABF	0	5	0	5	30	8	0	16	0	8	8
DOT	5	40	20	15	20	8	25	42	25	42	17
FCAP-flooded felt <sup>a</sup>	0	5	0	15	5	0	0	8	0	0	0
ABF-flooded felt <sup>a</sup>	5	0	0	10	5	8	0	8	0	8	17
DOT-flooded felt <sup>a</sup>	0	10	10	15	20	33	8	24	17	8	25
Felt alone <sup>a</sup>	0	20	30	15	20	25	25	42	33	33	33
Control	10	25	25	10	35	17	25	33	25	25	17

<sup>a</sup> Felt was applied between decking and stringer, and between stringer and cap.

# OBJECTIVE III

## EVALUATE PROPERTIES AND DEVELOP IMPROVED SPECIFICATIONS FOR WOOD POLES

### A. DEVELOPING IMPROVED PATTERNS FOR THROUGH BORING DOUGLAS-FIR POLES.

In previous reports, we have described a series of tests designed to evaluate the effectiveness of through boring for limiting internal decay at the groundline and the effective zone around an individual through bored hole. The purpose of these exercises was to develop a through boring pattern that used the least number of holes per unit area, while minimizing the risk of internal decay.

In field surveys of through bored poles in service in the Bonneville Power Administration, we found that most poles had excellent preservative penetration in the through bored zone. We rarely found poles with less than 85% preservative penetration in the through bored zone. One interesting note to our original survey was that we failed to detect any evidence of internal decay in the through bored zone in any pole sampled, even when the penetration in that zone was as low as 70%. These findings suggested that there may be some latitude with regard to the percentage of the cross section that must be treated in order for through boring to be effective. This approach makes some sense when one considers that skips or gaps in a through bored pole will tend to be surrounded by a heavily treated zone, making it difficult for fungi and insects to gain access to this small area of untreated wood. Furthermore, untreated areas are unlikely to be contiguous. Thus, a decay fungus would have to move from one untreated zone to another across a heavily treated zone where it would be killed. As a result, it may be possible to reduce the number of holes drilled in a given zone while maintaining a reasonable degree of reliability.

Decreasing the number of holes reduces labor costs associated with through boring, reduces potential strength impacts associated with the holes, and decreases the amount of oil impregnated into a pole in the groundline. All of

these factors should combine to reduce the cost of through boring.

Last year, we reported on trials to assess the distribution of preservative around through bored holes in Douglas-fir pole sections treated with creosote. We used creosote in place of the more commonly used pentachlorophenol because the light oil used in the latter treatment was difficult to accurately detect in split sections. We found that average longitudinal preservative penetration was 214 mm (+/-97 mm) above or below the treatment hole. Average preservative penetration laterally away from the treatment hole was 18.4 mm (+/- 4 mm). We used these figures as a guideline to develop through boring patterns with varying degrees of treatability. For example, the older BPA through boring pattern at the groundline used a series of 11 mm diameter holes drilled 225 mm apart longitudinally. The next hole was then moved downward 75 mm and over 50 mm. Each downward sloping line of holes was approximately 225 mm longitudinally from the next row. In addition, the outer holes were spaced a minimum of 62.5 mm in from the edge of the pole to reduce potential effects on bending properties (**Figure III-1**).

The results of our penetration measurements suggests that the longitudinal distance between holes could be increased substantially beyond 225 mm. A spacing of 400 mm between holes uses the average penetration of 200 mm as the guideline for treatment. Clearly, this pattern could result in some skips or gaps in treatment, but these should largely be surrounded by treatment. As a result the presence of gaps should markedly increase decay risk. The lateral spacing poses a bit more of a challenge. The original BPA specification calls for 50 mm between holes. Our data suggests that average penetration on each side of the hole was 18 mm. Thus, the current 50 mm specification appears to be applicable for any new pattern; however, we also evaluated the potential for

extending the lateral distance between holes to 80 mm based upon the range of penetration values found in our experimental sample. This increased distance would again increase the potential for skips or gaps, but these gaps would also likely be surrounded by treatment and should therefore be less susceptible to fungal attack.

The use of wider longitudinal and lateral spacing patterns would reduce the total number of holes required from 45 holes per square meter

of a 388 mm diameter pole for the original pattern to 30 per square meter for the 400 mm spacing and 15/m<sup>2</sup> for the 600 mm spacing. Clearly, these wider spacings would increase the risk that untreated wood would be left within the pole, but this risk should be reduced if the initial treatment surrounds the untreated pockets to the extent that fungi cannot penetrate the wood. Next year, we intend to investigate the treatment patterns using the above spacings.

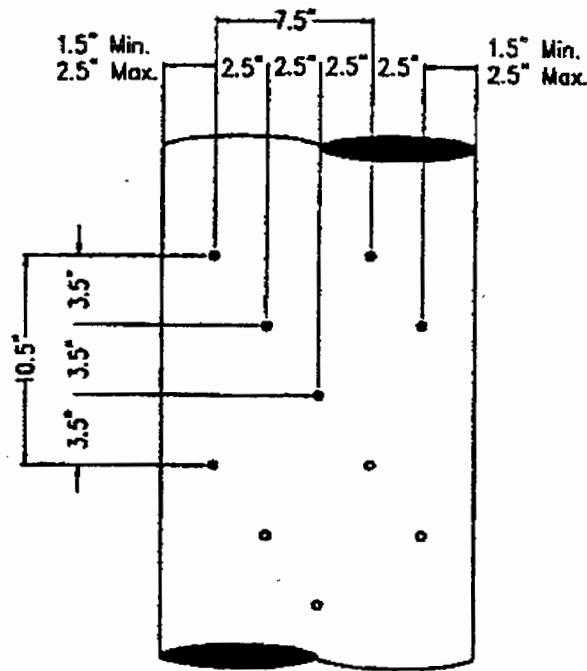

HOLE PATTERN DETAIL

Figure III-1. Typical spacing for through boring holes used by Bonneville Power Administration.

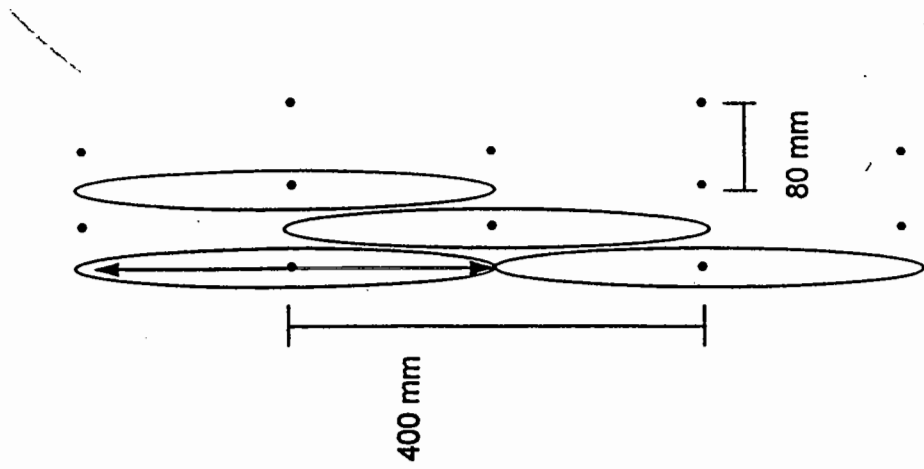

Figure III-2. Possible 400 m longitudinal spacing for through-boring holes to provide average coverage of pole cross section.

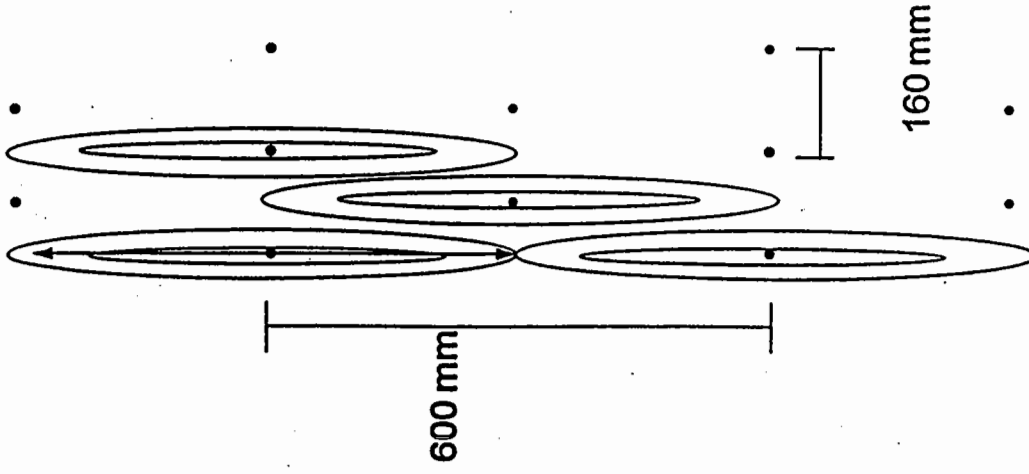

Figure III-3. Possible 600 m longitudinal spacing for through-boring holes to provide a minimum coverage of pole cross section based upon average preservative penetration plus standard deviation.

## **B. EVALUATION OF INSPECTION DEVICES FOR DETECTING AND ESTIMATING DECAY IN DOUGLAS-FIR POLES**

Over the past decade, a number of devices have emerged for the inspection of utility poles in service. These include acoustic devices that use either the time it takes for a sound wave to traverse a wood sample or those that examine the changes in acoustic waves as they pass through the wood, electronic drills that measured resistance to drilling, and computer programs for calculating residual strength of a pole based upon various wood measurements. While each of these tools has some potential for enhancing inspection precision, there are few comparative tests of these devices in comparison with existing inspection procedures.

Last year, as part of our efforts to develop more comparative information on utility practices, we initiated a project to assess various pole inspection devices. The goal was to identify a population of approximately 50 poles in the Corvallis area in varying stages of decay. The poles were then to be inspected in service using various inspection devices, including a conventional sound and bore procedure then returned to the laboratory, where they would be tested to failure in cantilever loading, then dissected to determine the locations of various defects. The ability of each device to detect these defects or to predict residual strength would then be assessed.

We have identified a population of 30 poles in the area ranging from 18 to 47 years old and in various conditions ranging from sound to reject (**Table III-1**). The poles were inspected in place using PoleTest, PURL1, and the Resistograph at various locations on each pole. The poles were are in the process of being pulled and returned to the Forest Research Laboratory. Once all of the poles have been removed, we

will test each pole to failure, then dissect with a chainsaw to map the internal defects. In addition, we intend to use a computer program, POLECALC to predict residual strength. The goal of this project is to develop comparative data on all 3 devices and the program on a single population of poles under similar conditions.

## **C. A SURVEY OF UTILITY MAINTENANCE AND REMEDIAL TREATMENT PRACTICES**

The rapid changes in utility management have been accompanied by marked shifts in how utilities perceive the wood poles in their systems. This is especially manifested in the need to extend the useful life of poles already in the system. One problem we have noted within utilities has been an increasing hesitancy to share information as competition for customers looms on the horizon. Yet, some problems are common to many utilities, making sharing of information essential for maximizing performance and profitability. An excellent example of the potential for information sharing is in the procurement and maintenance of wood poles. In 1983, a survey conducted by Graham and Goodell provided a comprehensive look at maintenance practices by North American utilities (Goodell and Graham, 1983). Much has happened in the intervening 25 years, but there have been no follow-up surveys to document these changes.

Last year, we developed a survey instrument to provide information on utility size, pole species used, maintenance practices and perceptions about initial and remedial treatments. The survey was mailed to approximately 1100 utility engineers across the United States using a list graciously provided by Engineering Data Management (Fort Collins, CO).

Table III-1. Poles to be used to assess the effectiveness of selected inspection devices.

Map No.	Pole No.	Tag No.	Area	Species	Class	Length	Year	Mfg.
1304	90605	354	Fayetteville Rd	DFP	3	40	1955	BAXCO
1204	295622	355	Oakville Rd	DFP	4	40	1965	BAXCO
1204	76001	357	Lamb Rd	DFP	4	40	1970	McFarland
1204	171800	358	Lamb Rd	DFP	?	35	?	?
1204	83302	359	Peoria Rd	DFP	3	35	1961	BAXCO
1104	327005	360	Highway 34	DFP	3	40	1964	BAXCO
1104	323006	361	Emmon's	DFP	4	35	1963	McFarland
1105	364601	362	School Farm	DFP	?	40	1962	?
1104	188070	363	Children's Farm	DFP	?	35	?	?
1104	187104	364	Children's Farm	DFP	4	40	1977	?
1104	295901	365	Garden Ave	DFP	?	35	?	?
1104	203400	366	Garden Ave	DFP	?	35	?	?
1104	300840	367	Golf City	WC	4	30	?	?
1105	357640	368	AT&T	DFP	?	?	?	?
1105	355406	369	Polk	DFP	?	30	?	?
1105	355444	370	Tyler	DFP	?	40	?	?
1205	101906	371	35 <sup>th</sup> and Long	DFP	3	40	1980	McFarland
1205	101901	372	35 <sup>th</sup> & Country Club	DFP	4	40	1952	BAXCO
1205	31001	373	35 <sup>th</sup> by Church	DFP/ Cellon	3	45		BAXCO
1205	31105	374	35 <sup>th</sup> by creek	DFP/ Cellon	4	45		Koppers
1205	31201	375	35 <sup>th</sup> by Western View School	DFP	3	55		BAXCO
1205	31701	376	Rogue Wave N	DFP	?	40		?
1205	31602	377	Rogue Wave S	DFP	?	45		McFarland
1205	31507	378	35 <sup>th</sup> & Western NE	DFP	4	45		BAXCO
1205	30502	379	35 <sup>th</sup> and Western NW	DFP	?	?		?
1205	31541	380	35 <sup>th</sup> and Western SW	DFP	4	40		BAXCO
None	No no.	381	35 <sup>th</sup> and Western SE	DFP	5	30		?
1205	31501	382	35 <sup>th</sup> and Western SW	DFP	4	45		?
1205	31502	383	35 <sup>th</sup> and Hillwood	DFP	3	55		BAXCO

**UTILITY POLE INSPECTION  
AND MAINTENANCE PRACTICES  
OREGON STATE UNIVERSITY,  
COOPERATIVE POLE RESEARCH PROGRAM  
Corvallis, Oregon**

In order to assist Utilities in their efforts to identify methods for prolonging the useful life of poles in their systems, the Oregon State University Cooperative Pole Research Program has designed this questionnaire to assemble comparative data on pole inspection and maintenance practices. Please take a few minutes to fill this out. The information you provide will be held in strict confidence.

1. In which state(s) is your utility located? \_\_\_\_\_

2. What type is your utility (check one)

- Electric  
 Telephone  
 Telecommunications  
 Other (please specify) \_\_\_\_\_

3. What is the ownership structure of your utility? (check one)

- Investor owned  
 Publicly owned  
 Other (please specify) \_\_\_\_\_

4. How many wood poles are in your system? \_\_\_\_\_ Total poles

5. At what upper KV limit do you stop using wood poles? \_\_\_\_\_ KV

6. Please indicate the approximate species makeup of the wood poles in your system.

Douglas-fir \_\_\_\_\_%  
southern pine \_\_\_\_\_%  
western redcedar \_\_\_\_\_%  
ponderosa pine \_\_\_\_\_%  
lodgepole pine \_\_\_\_\_%  
other \_\_\_\_\_% (please specify) \_\_\_\_\_  
Total = 100%



7. How many wood poles did your company purchase in 1997? \_\_\_\_\_ # of wood poles.

8. Based on the map below, please indicate the degree of biological hazard in your service area? \_\_\_\_\_ 1 - 5

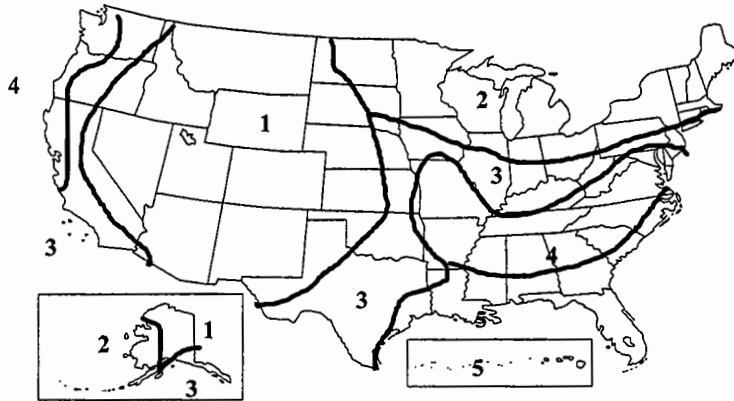

9. Indicate the type of initial treatments used on the poles you currently purchase.

- Pentachlorophenol \_\_\_\_\_%
- ACZA (Chemonite®) \_\_\_\_\_%
- Creosote \_\_\_\_\_%
- CCA \_\_\_\_\_%
- Copper naphthenate \_\_\_\_\_%
- Other \_\_\_\_\_% (please specify) \_\_\_\_\_
- Total = 100 %

10. Please check each of the following that you use on your Douglas-fir poles.

- Through-boring
- Radial drilling
- Deep Incising
- Do not use Douglas-fir poles

11. Who performs your new pole inspections? (check all that apply)

- In-house
- Third party

- Treating plant
- No inspection

12. What is the expected pole service life for the species you use in your system? (please check one answer for each species you use).

Years	Douglas-fir	southern pine	western redcedar	ponderosa pine	lodgepole pine	Other
10-20						
21-30						
31-40						
41-50						
51-70						
71-90						
> 90						

13. Do you have a regular inspection and maintenance program?

- Yes, (please continue with #14)
- No (please go to Question #17)

14. Who does your inspection/maintenance?

A.  In-house

- 1.  Line crews as part of line patrols
- 2.  Dedicated crews

B.  Outside (contractor)

- 1. Do you audit contractor inspection/maintenance? YES NO (CIRCLE ONE)
- 2. What percentage of poles are audited? \_\_\_\_\_ %

15. What is your typical inspection cycle for wood poles?

transmission poles \_\_\_\_\_ years

distribution poles \_\_\_\_\_ years

16. Please check all items below included in your inspection program for each species you use.

Inspection Procedure	Douglas-fir	southern pine	western redcedar	ponderosa pine	lodgepole pine	Other
visual						
sounding						
boring/drilling at the groundline						
boring/drilling below groundline						
moisture meter						
Shigometer						
Poletest						
Other						

17. What percentage of poles in your system experience carpenter ant attack? \_\_\_\_\_%

18. What treatment do you use to control carpenter ant infestations in your poles?

\_\_\_\_\_

19. What percentage of poles in your system experience woodpecker attack? \_\_\_\_\_%

20. How much did you spend on pole repair and replacement due to damage caused by woodpeckers in 1997?

\$ \_\_\_\_\_

21. What treatments do you use for woodpecker prevention or control (check all that apply).

Hardware cloth

Fiberglass barriers

Epoxy filler

Other (please specify) \_\_\_\_\_

22. Please mark all remedial treatments that you currently use in your program.

- |                                      |  |
|--------------------------------------|--|
| <input type="checkbox"/> CuRap20     | <input type="checkbox"/> Metham sodium (ISK-Fume, Wood-Fume) |
| <input type="checkbox"/> CuNapRap    | <input type="checkbox"/> Chloropicrin (Timber-Fume)          |
| <input type="checkbox"/> CopRNap     | <input type="checkbox"/> Methylisothiocyanate (MITC-Fume)    |
| <input type="checkbox"/> Patox       | <input type="checkbox"/> Sodium Fluoride                     |
| <input type="checkbox"/> PolNu       | <input type="checkbox"/> Borate rods (Impel)                 |
| <input type="checkbox"/> PolNu 15-15 | <input type="checkbox"/> Other (please specify) _____        |
| <input type="checkbox"/> Osmoplastic |  |

23. Please rate the following remedial treatments regardless of whether you use them, by circling the number you feel best describes each. Rate each treatment on both performance and safety.

POOR	1	2	3	4	5	EXCELLENT
------	---	---	---	---	---	-----------

Internal Remedial Treatments	Performance					Safety				
Metham sodium (ISK-Fume, Wood-Fume)	1	2	3	4	5	1	2	3	4	5
Chloropicrin (Timber-Fume)	1	2	3	4	5	1	2	3	4	5
Methylisothiocyanate (MITC-Fume)	1	2	3	4	5	1	2	3	4	5
Sodium fluoride (Fluor Rods)	1	2	3	4	5	1	2	3	4	5
Borate rods (Impel)	1	2	3	4	5	1	2	3	4	5
_____ Other	1	2	3	4	5	1	2	3	4	5

External Remedial Treatments	Performance					Safety				
Cu Rap 20	1	2	3	4	5	1	2	3	4	5
CuNapRap	1	2	3	4	5	1	2	3	4	5
CopRNap	1	2	3	4	5	1	2	3	4	5
Patox II	1	2	3	4	5	1	2	3	4	5
PolNu	1	2	3	4	5	1	2	3	4	5
PolNu 15-15	1	2	3	4	5	1	2	3	4	5
Osmoplastic	1	2	3	4	5	1	2	3	4	5
_____ Other	1	2	3	4	5	1	2	3	4	5

24. Which of the following wood substitutes/alternatives have you used in the last five years?

- Laminated wood poles
- Light duty steel
- Fiberglass
- Concrete
- Other (please specify) \_\_\_\_\_

25. What is your job title? \_\_\_\_\_

26. What is your primary field of training? (check one)

- |  |   |
|--|---|
| <input type="checkbox"/> Electrical engineer | <input type="checkbox"/> Mechanical engineer          |
| <input type="checkbox"/> Civil engineer      | <input type="checkbox"/> Forest products              |
| <input type="checkbox"/> Forestry            | <input type="checkbox"/> Other (please specify) _____ |

27. Have you had formal training in the area of wood as a material? YES NO

28. Please rank the following sources of information about wood poles according to how frequently you use them. Rank the most frequent as "1" down to the least frequent as "6".

- |                                |   |
|--------------------------------|---|
| (____) SHORT COURSES           | (____) CONTRACTORS                          |
| (____) TRADE JOURNALS          | (____) RURAL ELECTRIFICATION ADMINISTRATION |
| (____) OTHER UTILITIES         | (____) OTHER (PLEASE SPECIFY) _____         |
| (____) UTILITY POLE CONFERENCE |   |

Thank you for completing this questionnaire. Please return in the enclosed business reply envelope. No postage is required. If you wish to receive results of this study and a copy of OSU's Wood Pole Maintenance Manual, please attach your business card or provide your name and address below:

\_\_\_\_\_

\_\_\_\_\_

\_\_\_\_\_

\_\_\_\_\_

To date, we have received 173 completed surveys and had 70 surveys returned because of incorrect addresses. A second mailing of surveys is currently underway in order to improve the response rate. In addition, we have tabulated the first 107 survey responses for specific questions to provide a preliminary overview of the data.

The responses tabulated represented 107 electric utilities and one phone company. The results show that a majority of respondents were from public utilities or coops (69% of respondents). As a result, the number of poles per utility varied widely, from as little as 1500 poles to 3,000,000 poles. The average number of poles per respondent was 194,880 poles. The 87 utilities that provided information, replaced an average of 3220 poles per year/utility, a replacement rate of 1.65% per year. Although there are a variety of questions concerning chemical preferences, we have not tabulated the responses to these questions. We also inquired about the relative maintenance cycles used for transmission and distribution poles as well as the incidence of carpenter ant or woodpecker attack.

Most utilities (57 of 78 responses) inspected transmission poles on a 6 to 15 year maintenance cycle with most falling between 6 and 10 years. Distribution poles were inspected on a similar schedule suggesting that most utilities were attempting to meet the spirit of the National Electric Safety Code guidelines. A number of utilities appeared to have little or no inspection program for their distribution system.

Infestation levels of both carpenter ants and woodpeckers were relatively low at most utilities. Forty of 107 utilities responding to this question experienced no carpenter ant attack, while 54 experienced an ant attack rate of 1 to 5% of their poles. Four utilities experienced infestations of 10% or more of their poles with two utilities reporting attack on 20% of their poles. Eighteen of 96 utilities responding to the woodpecker question experienced no attack, while 72 experienced attack on 1 to 5% of their poles. Average losses to woodpeckers were \$48,840 per utility per year with a range from \$500 to \$500,000. Clearly, woodpecker and

carpenter ant infestations are localized problems with total woodpecker losses for the 96 reporting utilities approaching 5 million dollars per year. As data is analyzed, we plan to look more at regional differences in problems and practices.

The final question analyzed in the preliminary evaluation was what specifications were incorporated for Douglas-fir poles. Forty six utilities did not use Douglas-fir in their specifications. Of the remaining utilities that responded, most included deep incising in their specification, followed by through boring and radial drilling. A single utility specified kerfing. A number of utilities permitted more than one method for improving treatment at groundline, presumably to provide alternatives for treaters.

The preliminary results indicate that most utilities experience relatively low rates of replacement and have relatively low rates of carpenter ant and woodpecker attack. Once we encourage additional responses, we plan to analyze the remainder of the questions and provide more detailed results.

Table III-2. Responses to the Utility Pole Inspection and Maintenance Practices Survey.

1. Utility Type: 107 Electric; 1 telephone
2. No. of Poles: (97 responses) Avg. 194,880 poles/utility; 1,500 to 3,000,000 poles
3. No. of poles changed per year: (87 responses) 3,220 poles per year per utility

Ownership	
Investor Owned	28
Public	41
Coop	34
Gov/Municipal	3
None	2

Utilities using each for Douglas-fir (%)	
Throughboring	24
Radial Drilling	18
Deep Incising	35
Do not use Douglas-fir	46

Percent of Poles Attacked by:				
	0	1-5	6-10	>10
Carpenter Ants	41	54	8	4 (20%)
Woodpeckers	18	72	7	9 (80%)

Cost of Woodpecker Damage per Year (47 respondents) \$48,840/year (500 to \$500,000)

Typical Inspection Cycle (%)					
Pole size	1-5	6-10	11-15	16-20	>20 years
Transmission	16	47	10	3	2
Distribution	7	54	12	2	10

#### D. POLE DISPOSAL IN THE PACIFIC NORTHWEST

A properly treated wood utility pole provides a long, reliable service life. Eventually, however, even a properly treated pole must be replaced. If it is still sound, the pole can be removed for reuse within the system. This is particularly true for western redcedar poles, but it can also hold true for poles of other species. Some poles, however, are not salvageable and are subject to disposal.

For decades, utilities disposed of poles with little concern. In rural areas, the poles were given to landowners adjacent to the right-of-way or were cut up and left by the side of the road,

where they eventually disappeared. The remaining poles were placed in a dumpster and hauled to the local landfill.

The increased regulation of pesticides, and wood preservatives in particular, changed this approach for many utilities. First, the Environmental Protection Agency reviewed the use of all wood preservatives and decided that creosote, pentachlorophenol, and the inorganic arsenicals would all be restricted use pesticides. While this designation applied only to the chemicals and not the resulting treated product, the restricted use classification led many utilities to reevaluate how they handled treated wood. One common response was to provide a consumer information sheet to those receiving poles to ensure that they understood the handling aspects of the products.

The EPA also began to evaluate disposal of a wide variety of materials into the nation's landfills and began requiring the use of a Toxicity Characteristic Leaching Procedure (TCLP) to characterize the risk posed by wastes containing regulated materials such as wood preservatives. For wood, this procedure involved grinding the wood to a powder-like consistency, extracting the material, and analyzing the extract for EPA priority pollutants. Regulated levels were established based on the Clean Water Act and in addition, some states devised their own biological tests. Material that failed either test would be subject to disposal in a secure, lined landfill specifically designed to accept hazardous wastes.

Fortunately, extensive testing of treated wood using the TCLP procedures showed that virtually all materials passed these procedures and were disposable in any landfill. Some utilities still experienced difficulties in pole disposal, but these problems appeared to reflect a hesitancy on the part of landfill operators to accept large volumes of wood, which was relatively bulky, for a given weight.

In 1994, the EPA proposed lowering the TCLP limits for pentachlorophenol and creosote by a factor of 2 (Malecki, 1992). This proposal would have placed virtually all treated wood into the more restricted classification. The cost of such a proposal was prohibitive, and additionally, there was serious concern about the

existence of adequate landfill capacity to dispose of all treated material in this manner. Extensive testing by the Utility Solid Waste Advisory Group (USWAG) showed that the testing methodology applied to treated wood was inappropriate and the EPA declined to pursue more restrictive regulations (EPRI, 1990; Goodrich-Mahoney, 1992; Murarke et al., 1996). While the EPA continues to endorse reuse as the preferred disposal method, landfilling remains a viable option for poles that cannot otherwise be recycled.

The concerns about disposal of treated wood by utilities are in no way inconsequential. It is estimated that utilities have 160 to 170 million wood poles in service. Even at a 1% annual rate of replacement, utilities would dispose of 1.6 to 1.7 million poles per year. Using a Class 4, 40-foot long pole as the typical pole, this translates into nearly 55 million cubic feet of disposable wood. If all of this material was disposed of in conventional lined municipal solid waste facilities at \$40/cubic yard, the cost would be approximately 88 million dollars per year. Requiring this material to be disposed of in secure lined hazardous waste facilities increases this figure 10-fold to 800 million dollars per year.

As a result, disposal of treated wood remains a key concern of many utilities and has been addressed in a number of pole conferences.

In 1988, Hess surveyed utilities in the Pacific Northwest and received 65 responses. Most utilities indicated that they used pentachlorophenol-treated wood and more than half of them provided personnel training concerning safe handling of these materials. A majority of utilities gave away poles and made efforts to ensure that those receiving the wood were aware of its characteristics. Most poles that were not recycled or given away were transported to municipal solid waste facilities. Only six respondents stated that disposal of treated wood was influencing their choice of preservatives for new poles.

Nearly a decade has passed since the Hess survey and utilities are facing a dizzying array of choices as deregulation unfolds. The benefits and liabilities associated with an existing pole plant may strongly influence the its financial health. Disposal of treated wood after its useful

service may impact the "bottom line" on use of wood poles. As a part of the Utility Pole Conference, we resurveyed utilities in the western United States to determine how disposal attitudes had changed over the intervening 10 years.

**Survey Methods:** The survey instrument used by Hess (1988) formed the basis for a new survey. The survey was expanded to determine the size of the utility, the number of poles subject to disposal, and the cost of disposal.

The survey was mailed to 18 investor-owned utilities and 167 public utilities, cooperatives and municipal utilities in British Columbia, California, Idaho, Montana, Nevada, Oregon, Utah, Wyoming. Those surveyed were members of either the Western Electric Power Institute or the Northwest Public Power Association.

The responses were tabulated and duplicate responses from the same utility were compared and if they were similar, only one response was tabulated. The results were also compared with those from 1988 to determine if attitudes and programs had changed.

**Results:** A total of 62 surveys were returned for a 33.5% response rate (**Table III-3**). Response rates appeared to be lower among public utilities, cooperatives, and municipalities. The respondents had nearly 8.2 million poles in their systems and disposed of nearly 44,480 poles a year. These figures suggest that the respondents removed and replaced 0.55% of their poles per year, an excellent testimony to wood longevity. A majority of utilities that responded used treated wood for poles and crossarms.

As in the 1988 survey, pentachlorophenol remains the most commonly used preservative, followed by copper naphthenate and creosote. Arsenicals such as chromated copper arsenate (CCA) or ammoniacal copper zinc arsenate (ACZA) remain the choice for a relatively small percentage of the poles in the utility system. It is interesting to note that the number of utilities with some copper naphthenate in their systems more than doubled over the last 10 years. This preservative was widely touted as a penta replacement.

Most utilities provided training concerning treated wood to their personnel, although the



frequency of this training varied. A slight majority of utilities provided protective clothing to line personnel, but this appeared to primarily constitute supplying gloves.

A majority of utilities responding continue to give away poles. Only eight respondents send poles to a hazardous waste landfill and a number of these only did so when unable to give away the wood. Twelve utilities sold their used poles and two resawed the wood for other products.

Sixty-one percent of the utilities giving away poles provided a consumer information sheet to the receiver, 56% required that the receiver sign an indemnification agreement, and nearly all of those requiring this document maintained a permanent record of the transaction. These results indicate that, while utilities continue to give away used poles, they have taken steps to ensure that those receiving this wood understand its properties. However, only 13 percent of respondents labeled poles properly to warn against burning.

The bulk of utilities were subject to State or Federal regulations regarding disposal. Only two respondents were subjected to additional local regulation. Pole disposal appeared to represent a relatively minor cost to the majority of utility

respondents. Forty-five of the fifty-four respondents to this question stated that they spent less than \$50,000 per year on pole disposal and a number of these spent nothing. Seven utilities spent \$50,000 to \$250,000 per year and two utilities reported spending over \$500,000 a year on pole disposal. With a few exceptions, disposal costs appear to represent a relatively minor expense for a utility.

Most utilities reported that they had no difficulty in locating landfills willing to accept treated wood. The lack of difficulty in identifying disposal options and the relatively small cost of disposal suggests that this factor should have little effect on selection of preservatives for new poles. However, over 40% of respondents stated that disposal options had influenced their preservative selection. Only six of 65 respondents gave a similar answer in the 1988 survey. These results suggest that utility perceptions concerning pole disposal deviate from the reality. The implications of this trend on utility preference is unknown, but it suggests that wood pole and crossarm producers must continue to educate utilities concerning the economical disposal options available.



## UTILITY POLE CONFERENCE SURVEY OF HANDLING AND DISPOSAL PRACTICES OF NORTHWEST UTILITIES

In order to assist utilities in assessing their needs with regard to pole disposal, Oregon State University, in cooperation with the Northwest Public Power Association and the Western Electric Power Institute have designed this survey. Please take a few minutes to fill this out. The information you provide will be held in strict confidence.

1. Which of the following treated wood products are used by your utility?

- Poles
- Crossarms
- Construction timbers and beams

2. What type of wood preservatives are used?

- Pentachlorophenol
- Creosote
- Inorganic arsenicals
- Copper naphthenate

3. Approximate number of wood poles in your system \_\_\_\_\_ (x1000).

### HANDLING PRACTICES

4. Does your utility provide training about the safe use and handling of treated wood?

- Yes
- No

5. How often is the training offered?

- Annually
- During new employee training
- Other

6. Is protective clothing provided for the handling of wood products?

- During construction:     Yes  
    No
- During maintenance:     Yes  
    No

7. If yes, which of the following are provided?

- Gloves
- Suits
- Pants
- Coveralls
- Jackets

### DISPOSAL PRACTICES

8. How many poles are removed from service each year for disposal \_\_\_\_\_.

9. How do you dispose of used poles that are no longer serviceable?

- Give away
  - Landfill (sanitary)
  - Hazardous waste landfill
  - Incinerator or co-generation
  - Other (please specify)
- \_\_\_\_\_

10. If you landfill, have you experienced difficulty in obtaining access to this disposal option?

- Yes
- No

**If you give poles away, please answer questions 10 through 12.**

11. Are warning signs placed on the wood products, restricting the use to outdoor use and warning about toxic fumes caused by burning treated wood?

- Yes
- No

12. Is a consumer information sheet given to the person receiving the treated wood?

- Yes  
 No

- Provincial  
 Agriculture Canada  
 Other

13. a. Is an indemnification agreement signed by the person receiving the treated wood?

- Yes  
 No

14. How much do you spend each year on disposal of treated wood (x \$1,000)?

- 0-50  
 50-100  
 100-250  
 250-500  
 > 500  
 U.S. \$  
 Canadian \$

b. Are copies of the signed agreements permanently filed?

- Yes  
 No

**FUTURE PLANS**

13. Which regulations (if any) regulate the disposal of your treated wood products?

- State  
 U.S. Environmental Protection Agency

15. Have current or possible future handling and disposal problems with treated wood affected your choice of preservative?

- Yes  
 No

Table III-3. Responses to the Pole Disposal Survey

Commodities Subject to Disposal	No. of Respondents
Poles	62
Crossarms	57
Construction Timbers/Beams	26

Preservative Used	No. of Respondents
Pentachlorophenol	59
Creosote	14
Inorganic Arsenicals	3
Copper Naphthenate	20

Number of Poles in System/Year	No. of Respondents
<10,000	12
10,000 - 30,000	15
30,001 - 50,000	10
50,001 - 100,000	1
100,001 - 200,000	5
200,001 - 500,000	5
> 500,001	3
Average (Standard Deviation)	156,860 (244,000)

Number of Poles Disposed	No. of Respondents
< 50	9
50-100	15
101-500	25
501-1,000	2
1,001-5,000	2
5,001-10,000	2
10,000	1
Average (Standard Deviation)	809 (1352)

Does utility provide training?	No. of Respondents
Yes	38 (66%)
No	20 (34%)

How often is training offered?	No. of Respondents
Annually	12
New employee training	11
Other	23

Is protective clothing provided during:	No. of Respondents
Construction	
Yes	31 (53%)
No	28 (47%)
Maintenance	
Yes	31 (53%)
No	27 (47%)

Clothing Provided	No. of Respondents
Gloves	32
Suits	2
Pants	1
Coveralls	8
Jackets	3

Pole Disposal Options	No. of Respondents
Give away	48
Landfill	28
Hazardous landfill	8
Incinerator	3
Sell	12
Resaw	2
Other	4

Have you experienced difficulty in locating landfills?	No. of Respondents
Yes	9 (22%)
No	32(78%)

Are warning signs attached to poles restricting use to outdoors and warning against burning?	No. of Respondents
Yes	7 (13%)
No	47 (87%)

Do you attach consumer information sheets to poles that are given away?	No. of Respondents
Yes	36 (61%)
No	23 (39%)

Is an indemnification agreement signed by person receiving wood?	No. of Respondents
Yes	32 (54%)
No	27 (46%)

Are copies of this agreement permanently filed?	No. of Respondents
Yes	30 (55%)
No	25 (45%)

Who regulates disposal of your treated wood products?	No. of Respondents
State	34
US EPA	28
Provincial	2
Ag Canada	-
Other	2 (local)

How much do you spend each year on pole disposal?	No. of Respondents
< %50,000	45
\$50-100,000	1
\$100,000 to 250,000	6
\$250,000 to 500,000	-
> 500,000	2

Has pole disposal affected your choice of wood preservation on new poles?	No. of Respondent
Yes	27 (44%)
No	34 (56%)

### **E. EVALUATING THE LOAD CAPACITY OF GLULAM DAVIT ARMS AFTER TWENTY YEARS OF EXPOSURE**

In the late 1960s, many utility companies searched for ways to minimize the visual impact of their overland transmission structures. A change from straight to upswept transmission arms, thought to be visually more appealing, was adopted by many of these utilities. At the same time, utilities were searching for preservative treatments that left the wood cleaner. The development of the Cellon® and Dow® processes answered many of these needs. The processes dissolve pentachlorophenol in liquified petroleum or methylene chloride, instead of the heavier oils more commonly used to treat utility poles. Once the pressure is released at the end of the treatment process, the volatile solvents evaporate, thus leaving the pole clean and dry (Davies, 1971; McOrmand et al., 1978; Parmeswaren et al., 1985; Resch and Argenbright, 1971; Wilcox, 1975). Although the Cellon® and Dow® treatments were later found to have significant performance problems in soil-contact exposures (Hand and Lindgren, 1975; Lew and Wilcox, 1981), they were widely used, particularly in the western United States.

Approximately 20 years ago, an Oregon-based electrical cooperative placed many new lines in service. The utility poles used in these lines had upswept, glue-laminated timber (glulam) davit arms treated by the Cellon® process. The National Electrical Safety Code (NESC) (Institute of Electrical and Electronic Engineers, 1977) requires an overload capacity of 4.0 for wood transmission arms for new installations. Replacement of wooden arms is required when the overload capacity of the arms drops to 2.67, a reduction to 66 percent of the original allowable load.

Recently, above-ground inspection revealed that some upswept arms were checked and potentially weakened. These arms were removed from service and returned to the utility cooperative. The utility also had stored arms that had never been in service and decided to have one tested destructively. The arm failed at a load that was less than the overload capacity required by the NESC. This raised the question

concerning how 20 years of service would affect the performance of davit arms.

The purpose of this paper is to present an analysis of the probable capacity and stiffness properties of the glulam davit arms after 20 years of line service. Although davit arms are selected on the basis of both vertical and horizontal load requirements, only vertical loading is addressed in this discussion.

In the early years of electrification in the United States, cost and availability were the driving factors for distribution system design (Coe, 1967). The goal of widespread electrification at the lowest possible cost was accomplished by installing overhead lines that were sufficiently durable to survive many years of service under a wide range of environmental conditions. Wooden utility poles and cross arms worked well for this. Although cost and electricity availability were still major objectives of design in the late 1960s, other concerns were emerging—in particular, the visual impact of utility lines on the viewscape.

Under pressure for beautification, power companies were faced with two options: either install utilities underground or develop more visually appealing distribution structures (Coe, 1967). Underground utilities were then, and still are today, the most expensive electrical distribution option. Power companies chose to develop more visually appealing structures. The new designs were primarily intended for use in rural areas where there were no trees to conceal utility structures (Coe, 1967).

During the late 1960s, glulam was becoming recognized as a viable alternative to solid wood for utility structures. Glulam has many advantages over solid sawn wood; these advantages include reduced variability, efficient utilization of fiber, and fabrication of curved and tapered sections in large sizes.

Glulam was used for poles in many locations across the United States. In addition, designers extended the use of glulam to cross arms, and developed a variety of unique utility structures. Many of these structures were impractical or not cost-competitive with existing materials, but some utilities used curved/tapered davit arms widely. Although the curved/tapered davit arms

were not exposed to the severe environment typical of soil contact, they were exposed extensively to ultraviolet light, as well as to repeated freeze-thaw and wet-dry cycles and mechanical fatigue. These environmental and mechanical effects could combine to affect the integrity of the glueline, thus potentially weakening the structures.

**Materials and Methods:** A nonparametric statistical approach, as described in ASTM D 2915 (1996b), was used to identify a minimum sample size of 28 specimens. This sample size produced a confidence level of 75 percent when the first order statistic was used as the tolerance limit. In addition, this sample size was adequate for estimating mean stiffness with at least the same degree of confidence. The samples were taken from the utility's inventory of davit arms removed from service. After removal, the arms had been stored outside for an unknown period of time at a site that receives less than 250 mm of rainfall per year.

The glulam davit arms were used to support transmission lines in eastern Oregon, where precipitation is low and a marked change in temperature occurs seasonally. The davit arms received at the laboratory for testing had two different geometries. **Figure III-4** and **Table III-4** give the dimensions and radius of curvature at the neutral axis ( $R_m$ ) for the two configurations, referenced as type A and type B. Type A had a larger upward angle, approximately 30 degrees to the horizontal at the heel, whereas type B was pitched at approximately 22 degrees to the horizontal at the heel. The davit arms were glulam made with 26F Douglas-fir (*Pseudotsuga menziesii* [Mirb.] Franco) lumber and phenol resorcinol adhesive. They had been treated by the Cellon® process prior to installation. The type A davit arms had been painted, but the actual date of painting could not be determined.

The arms were designed to be mounted in a metal bracket attached to the utility support structure. Each arm used in this study was still attached to its metal mounting bracket. The metal mounting brackets were similar in construction for the two configurations.

When received at the laboratory, the arms

were placed inside and allowed to air dry. No attempt was made to condition the arms to an equilibrium moisture content. The metal mounting brackets were removed, and visible features, such as knots, finger joints, delamination, and severe checking, were mapped.

A standard method was not available for davit arm testing; therefore, we followed a procedure based on ASTM D 198 (1996a). The arms were subjected to flexure in a universal testing machine. A fixture (shown in **Fig. III-5a**) was fabricated so that the arm with its bracket could be mounted in the testing machine. Each davit arm specimen was bolted into the bracket as used in service. A displacement transducer was attached to the traversing crosshead of the testing machine so that displacement of the arm tip could be measured. The heel of the arm was also instrumented to measure rotation in the bracket; however, it was found that rotation was negligible. The davit arm was loaded in the same direction as its service load through the eye bolt located at the end of the arm where the transmission wire had been hung (**Fig. III-5b**). A universal linkage connected the davit arm to the traversing head of the testing machine. The universal testing machine was operated under displacement control. We estimated that a loading rate of 15 mm/min would be appropriate to reach a maximum load in 10 minutes. An electronic load cell was used to measure loading force. Load and deflection data were recorded throughout the test by a computer-controlled data acquisition system.

Once the ultimate load was reached, the davit arm was removed from the fixture and the failure mode assessed. A specimen for measuring moisture content was cut from the arm. Later, the davit arms were each cut between the shear plate and the heel of the arm to assess the degree of wood failure in the failure region.

**Results and Discussion:** The original design notes for the type B arms assumed an ultimate fiber-bending stress at failure of 38 MPa. This stress and the section modulus at the heel of the member, where the cross section was nominally 79 by 203 mm, were used to estimate the



ultimate vertical breaking load at 15 kN. Catalog specifications for arms of the type B configuration showed a rated ultimate load of 14 kN. Given an overload capacity factor of 4.0, the allowable load would have been 3.5 kN. Correspondence accompanying the davit arms indicated that one of the arms had been tested to 8.9 kN without failure; this load was 2.5 times the design load. A deflection of 60 mm was recorded at 8.9 kN. The stiffness could be stated as 148.5 kN/mm according to the ratio of the measured deflection to the load. The maximum bending stress was expected to occur at the outer fibers on the tensile side of the davit arm on the vertical plane passing through the minimum section having the shear bolt. In our tests, this occurred at the top surface of the davit arm. The neutral axis was shown to be at the top of the shear bolt. Thus, the distance to the outer fiber was the distance from the top of the shear bolt to the top surface.

The bending stress was first computed according to simple beam theory, in keeping with the original design analysis. By this approach, the bending stress ( $f_b$ ) shown in **Table 1** was determined by:

$$f_b = \frac{12PL_e c}{bd_c^3}$$

where  $P$  = breaking load,  $L_e$  = distance from centerline of the eye bolt to the vertical plane passing through the shear bolt,  $c$  = vertical distance from the top of the shear bolt to the top of the beam,  $b$  = thickness, and  $d_c$  = depth of the beam in the vertical plane passing through the shear bolt. By this method, the mean ultimate bending stress was 21.63 MPa for type A, and 27.95 MPa for type B davit arms.

In keeping with current design standards, the davit arms were not straight and, for that reason, the calculated bending stress was increased by a shape factor,  $K_\theta$  (AITC, 1994). Thus, the maximum bending stress at the critical section also was calculated as:

$$f_{bc} = K_\theta \frac{12PL_e c}{bd_c^3} \quad (2)$$

here the variables are as previously defined. The shape factor  $K_\theta$  was estimated by (AITC, 1994):

$$K_\theta = D + E(d_c/R_m) + F(d_c/R_m)^2 \quad (3)$$

where  $D$ ,  $E$ , and  $F$  are dimensionless coefficients from Table 5.10 in AITC (1994),  $d_c$  = depth of the member in the vertical plane of the shear bolt, and  $R_m$  = radius of curvature of the centerline of the member. The angle from horizontal at the top surface in the vertical plane passing through the shear bolt was used as the reference angle in  $K_\theta$ . For type A and type B arms,  $K_\theta$  was 2.387 and 1.961, respectively. The modified bending stress results for type A and type B arms are given in **Table III-5**.

The variability is crucial in the fiber stress approach to allowable load determination. The coefficient of variation for types A and B was 15.4 and 17.1 percent, respectively. These values were typical of glulam in the original condition. Thus, there was no change in the variability of the maximum bending stress in the population.

A Student's t-test was used to test the hypothesis that the two types of davit arms did not differ significantly. The maximum bending stresses and ultimate loads of the two configurations were significantly different ( $\alpha = 0.01$ ).

Shear stress was calculated at the shear bolt section using conventional beam theory, because this was the practice used by the original design engineer. The net area of the section perpendicular to the radial centerline of the member was used; the section reduction equivalent to the area of the bolt hole was taken

into account but the effect of the shear plate on the cross-sectional area was neglected. The assumptions embodied in Equation [4] were that the neutral axis passed through the geometric center of the davit arm and that maximum shear stress,  $f_v$ , occurred at that plane in the davit arm.

$$f_v = \frac{1.5V}{bd} \quad (4)$$

where  $V$  = the shear force at the shear bolt,  $b$  = thickness of the davit arm, and  $d$  = depth of the davit arm through the shear bolt on a plane perpendicular to the radial longitudinal plane.

Finite-element modeling of davit arm type A demonstrated that the neutral axis location was influenced by the forces carried by the shear bolt. For straight single-tapered cantilevered members, the maximum shear stress is located at the neutral axis only where the moment is zero, i.e., at the loaded tip (10). Elsewhere, the maximum shear stress can occur within the section or at the tapered edge, depending on the degree of taper. The finite-element analysis indicated that the maximum shear stress occurred at the top surface on the section passing through the shear bolt perpendicular to the longitudinal midplane; this point is located on the top surface about 50 mm from the vertical plane of the shear bolt toward the heel. At this section, the maximum shear stress, is expected to be (10):

$$f_{xy} = \frac{(1.5V)}{bh_o} \quad (5)$$

where  $K_v = 8/9$ ,  $V$  = the shear force at the section, and  $h_o$  = the davit arm depth at the free tip.

The ratio of free-end depth ( $h_o$ ) to depth at the critical section ( $h$ ) was 0.67. The form of the shear stress distribution where this depth ratio exists is expected to be linear from zero at the bottom to that given in Equation [5] at the top

(Maki and Kuenzi, 1965). In this case, the shear calculated according to the tapered beam functions, 3.0 MPa and 3.8 MPa for arm types A and B, respectively, was significantly different from that calculated according to simple beam theory, 4.1 MPa and 5.0 MPa for types A and B, respectively. Furthermore, the location of the maximum shear stress is not where it is assumed to be according to simple beam theory. The tapered beam analysis suggested that initial failures resulting from shear would be expected toward the outer fiber. In addition, the shear span-depth ratio between the shear bolt and the heel bolt was small, approximately 1.5:1. Thus, failures were expected to initiate in the outer laminae of the high shear region and to radiate toward the heel of the arm.

The hypothesis that the maximum shear stresses of the two davit arm types were statistically the same was tested by a Student's t-test. As a result, the inference was that the maximum shear stresses (based on simple beam theory and curved/tapered beams) were significantly different ( $\alpha = 0.01$ ). Given this difference, in combination with the statistical outcome of the bending stress findings, we decided to keep the two configurations separate, rather than pool the results to determine allowable service loads.

When loaded, the davit arms exhibited a linear load-deflection relationship until the first failure. The first failure occurred between 50 and 80 percent of the ultimate load.

For this study, bending stiffness was defined as the ratio of load to deflection in the linear portion of the load-deflection trace. This expression was used because the tapered and curved geometry made the solution for the elastic modulus exceedingly complex. According to the load-deflection relationship, the mean stiffness of the type A davit arms was 105.8 N/mm, and that of the type B davit arms was 108.7 N/mm. A Student's t-test, used to determine whether or not the type A and type B stiffnesses were equal, indicated that the stiffnesses of the davit arms of the two geometries were not significantly different.

Many of the failures were shearlike failures in the outer gluelines at the top of the member.

Some members failed by splitting from the shear bolt to the heel. These failures were probably the result of type-I fracture. Prior testing of a single davit arm by others (Hughes Brothers, personal communication, 1995) yielded tensile failures resulting from bending on the top surface of the davit arm. It is not known whether the difference in failure mode was a result of aging, the method of testing, or differences in moisture content.

The failure surfaces showed a significant amount of interlaminar weathering. The average wood failure was approximately 77 percent. Approximately 21 percent of the inner surfaces of the failure pathway showed some degree of weathering. This suggests that delamination was occurring at the edges of the davit arms. Given the limited penetration of ultraviolet light into the wood, the effects on gluelines appear to be a function of the cyclic environmental conditions to which the arms were exposed.

Davit arm load capacity has traditionally been assigned as the mean capacity divided by 4.0, where 4.0 is the overload capacity (IEEE, 1977). This assignment of load capacity appears to offer a factor of safety equal to 4.0. However, the method fails to incorporate the variability of the population. Recently, Hernandez et al. (1995) recommended that glulam utility structures be designed on the basis of a fiber stress value. This is a departure from the empirical ultimate load used by the NESC. The fiber stress basis provides a mechanism to explicitly incorporate variability into the assigned working load.

The allowable load capacity can be determined by rearranging Equation [2] and substituting the allowable bending stress ( $F'_b$ ) for calculated stress, as in:

$$P = \frac{F'_b b d_c^3}{12 K_\theta L_e c} \quad (6)$$

The original design specifications for a type B arm showed that the wood was to have the

base allowable bending stress  $F_b = 18$  MPa. If the original bending stress is modified for duration of load ( $C_D$ ) with dead load plus snow load, then  $F'_b = 18 (1.15)$  MPa, and Equation [6] for a type B davit arm yields  $P = 3.8$  kN. For a type A arm, the load capacity would have been 3.18 kN. Thus, the allowable load developed by the simple NESC rule and the engineering analysis resulted in initial allowable loads that differed by only 7 percent.

According to experimental data for the types A and B davit arms with the derivation of Hernandez et al. (1995), the allowable bending stresses were determined as:

$$F'_b = \frac{f_{bcm} [1 - K(CV)]}{2.1} C_D \quad (7)$$

where  $f_{bcm}$  = mean bending stress for the curved/tapered davit arms,  $CV$  = coefficient of variation,  $K$  = factor for one-sided tolerance limits for normal distributions (3), and  $C_D = 1.15$ . The  $K$  factor reflects the degree of confidence required for the application. For some applications, a confidence level of 75 percent is adequate. However, for other applications a 95 percent confidence level, or even a 99 percent confidence level, may be needed to fulfill the risk requirements of the user. A  $K$  factor based on 95 percent confidence seems appropriate for an infrastructure application in which a failure could result in considerable expense and electrical service interruption. The constant 2.1 in Equation [7] is used to adjust the test duration to normal use and includes a factor of 10/13 for manufacture and use. According to Equation [7],  $F'_b$  is 15.0 MPa and 13.1 MPa for types A and B, respectively, after 20 years of service.

In Table 2, the mean ultimate load capacity of the type A arms was 8.0 kN, whereas for type B arms, the mean capacity was 10.1 kN. According to the NESC approach, the overload capacity for types A and B, respectively, are now 2.50 (1,776/710) and 2.65 (2,257/849). Both of these values are at or below the minimum overload criteria of 2.67 (IEEE, 1977).

Application of the NESC rule based on mean strength values, but neglecting the variation, would lead to the decision to remove the arms from service.

When the load capacity is based on the fiber stress analysis, the capacity of type A arms is 0.84 of the original value (594/710). The ratio of original to current capacity for type B arms is 0.61 (518/849). The effect of confidence level on allowable load is demonstrated by type B davit arms, which would have an allowable capacity of 3.5 kN at a 75 percent confidence level. However, at a 99 percent confidence level, the allowable capacity would be 2.0 kN. The choice of confidence level swings the ratio of residual strength from 0.93 to 0.52 of original capacity. The choice of confidence level dictates whether one concludes that the davit arms should remain or that they should be removed from service. We should employ the same criteria for replacement in the fiber stress evaluation as in the NESC rule, which requires 66 percent of the original capacity. Thus, at a 95 percent confidence level for allowable stress determination and according to the information showing delamination, we conclude that the type B arms should be removed from service, but that the type A arms could remain.

It is appropriate to indicate that the fiber stress design practice for glulam utility structures (Hernandez et al., 1995) would adjust the bending stress for tension laminations ( $C_t = 0.85$ ), type of loading ( $C_L = 0.62$ ), and curvature ( $C_c = 0.96$ ) (1), in addition to duration of load, to obtain an allowable bending stress. Thus, these davit arms would have had lower initial allowable loads.

**Summary:** The development and assessment of capacities for davit arms are crucial to uninterrupted electrical service where davit arms are installed in the service lines. This paper addresses vertical loads, but the approach also can be used for horizontal load capacity. The NESC method of allowable capacity determination and assessment is based on ultimate capacity and does not incorporate the variability of the population. Assignment of allowable capacity on the basis of fiber stress and

engineering analysis is a rational alternative approach for design and assessment and explicitly incorporates the variability of the population.

For example, davit arms from an eastern Oregon electrical cooperative were removed after 20 years of service and tested to evaluate residual working loads. Two types of davit arms, referred to as A and B, were studied. The principal difference between the two arm types was the radius of curvature of the centerline ( $R_m = 4,216$  mm for type A and 4,420 mm for type B); further, the type A arms had been painted. In general, we found that:

- ▶ The type A and type B arms had similar stiffness after 20 years of service. The stiffness after 20 years of service was 71 percent of the single stiffness measurement known prior to service.
- ▶ The mean ultimate capacity of the type B arms after 20 years of service was significantly lower than the original value.
- ▶ The maximum bending stress was significantly different between type A and type B arms, but in both types the maximum bending stress occurred at the outer fiber in the vertical section through the shear bolt.
- ▶ The maximum shear stress was significantly different between type A and type B arms. For these curved/tapered configurations, the maximum shear stress occurred near the outer fiber on a section passing through the shear bolt and perpendicular to the curved midplane.
- ▶ When evaluated as a curved/tapered beam, the initial failure modes and locations appeared to be shear failures and corresponded with the high shear stress region.
- ▶ The NESC method of evaluation indicated that the arms are below the minimum 2.67 overload capacity, and should be removed from service.
- ▶ Analysis of capacity according to a fiber stress and engineering analysis approach that incorporated testing results suggested that the type B arms should be removed from service,

especially when combined with other performance indicators, such as lowered bending stiffness and delamination. The type A arms were performing at the lower limit of the allowable performance envelope.

- ▶ Ultimately, the decision about when to replace the davit arms is a function of capacity, as well as other risk assessment and liability factors that a given utility recognizes.

Table III-4. Physical measurements for Type A and Type B davit arms.

Measurement <sup>a</sup>	Type A	Type B
L (mm)	1,829	1,829
L <sub>c</sub> (mm)	1,295	1,257
l (mm)	150	150
D (mm)	610	406
d (mm)	189	195
d <sub>c</sub> (mm)	208	210
c (mm)	125	134
R <sub>m</sub> (mm)	4,216	4,420
Θ <sub>b</sub>	24	20
Θ <sub>h</sub>	30	22
h <sub>o</sub>	137	137
b (mm)	79	79
<sup>a</sup> as delineated in Figure 1; b = thickness		

Table III-5. Results of testing type A (n = 17) and type B (n = 11) davit arms.

Property	Type A		Type B	
	Mean	CV (%)	Mean	CV (%)
Maximum				
load (kN)	7,903	15.4	10,111	17.1
Stiffness				
(kN/mm)	105.8	12.9	108.7	15.7
Moisture				
content (%)	11.4	16.5	10.9	15.0
f <sub>b</sub> (MPa)	21.63	15.4	27.99	17.1
f <sub>bc</sub> (MPa)	51.64	–	54.82	–
f <sub>v</sub> (MPa)	4.14	–	5.06	–
f <sub>xy</sub> (MPa)	3.01	–	3.83	–

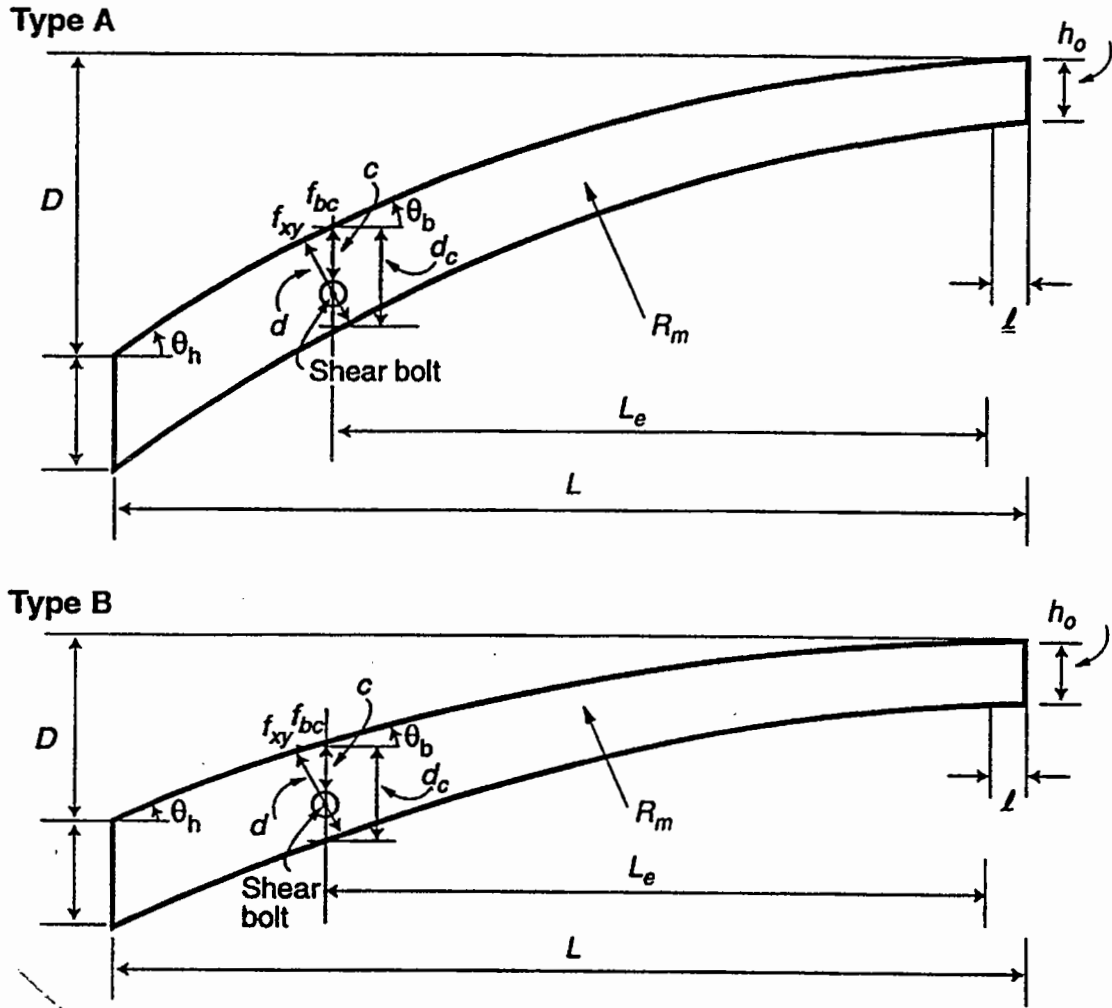

Figure III-4. Geometries of the two types of davit arms tested.

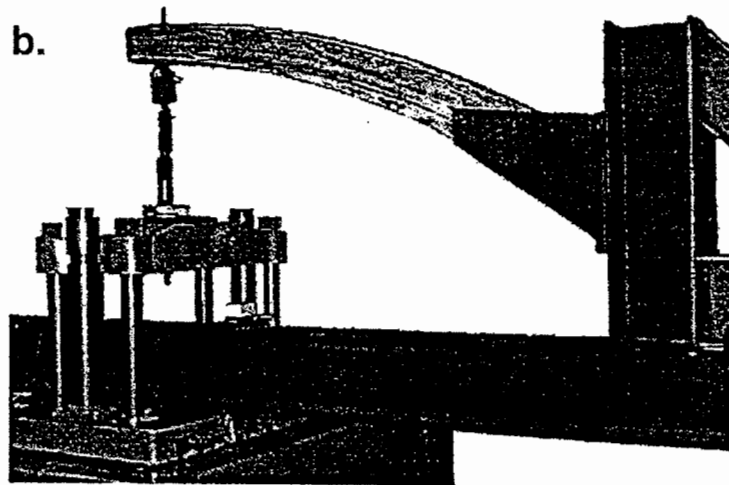
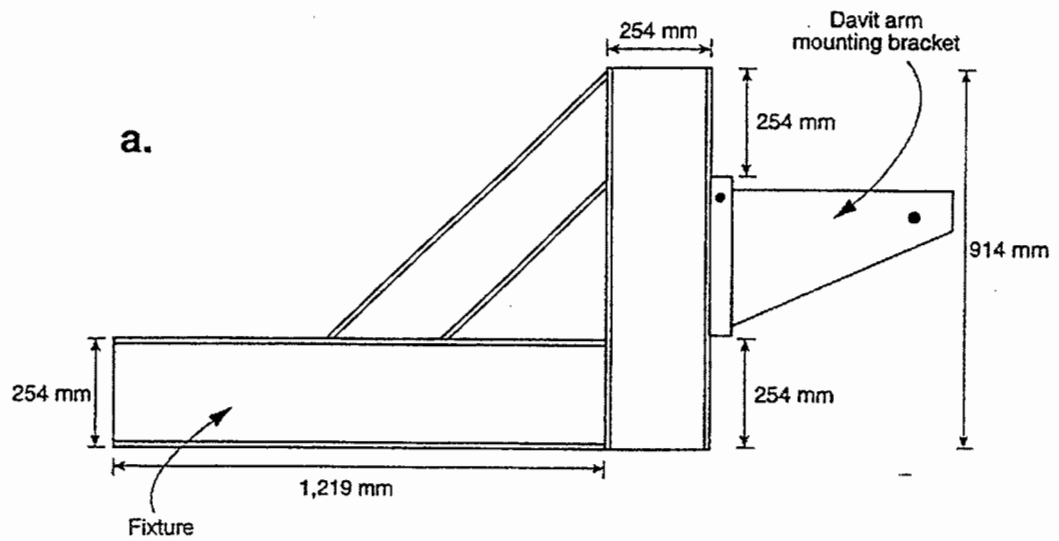

Figure III-5. (a) Fixture used to mount the davit arms in the universal testing machine. This fixture was fabricated from steel I-beams and affixed to the base of the testing machine. (b) A davit arm while subjected to loading.



# OBJECTIVE IV

## PERFORMANCE OF EXTERNAL GROUNDLINE BANDAGES

The treatment of wood with an American Wood Preservers' Association standardized chemical to the recommended retention using pressure processes normally assures a utility of a pole which will perform reliably under a variety of climatic conditions; however, in some locations specific chemical/wood species combinations can become susceptible to a gradual decay around the outer surface of the pole. The decay occurs as the result of a gradual depletion of chemical from the wood surface; a process that permits the growth of a group of preservative tolerant fungi that cause a decay type known as soft rot. Soft rot attack is normally a slow process, but its occurrence on the outer surface and its tendency to gradually reduce the effective cross section of the pole make it especially important for utility poles.

Soft rot attack is normally controlled by application of supplemental preservative pastes to the below ground portion of the pole at 10 to 15 year intervals. For many years, these pastes contained combinations of creosote, pentachlorophenol, dinitrophenol, sodium fluoride and chromium. The outcome of the 1977 EPA evaluations of wood preservatives resulted in the listing of chromium, creosote and pentachlorophenol as restricted use pesticides that could only be used under the direct supervision of an applicator who had passed an appropriate state administered test. This development encouraged many commercial formulators of preservative pastes to reformulate their systems to eliminate the restricted -used components. The result were a series of formulations based upon copper naphthenate, boron, or sodium fluoride. While each of these chemicals had a long history of fungicidal performance, relatively little was known about their performance in a groundline system. To alleviate these gaps, we initiated a series of field trials on untreated Douglas-fir

pole sections at our Corvallis test site. In addition, we established field trials in both New York and California on in-service poles. The Corvallis test has been completed, while the two utility test sites are still under evaluation. This past year, we also installed several recently developed formulations in pole tests at our Corvallis test site.

### A. EVALUATION OF SELECTED GROUNDLINE BANDAGES IN DOUGLAS-FIR, WESTERN REDCEDAR, AND PONDEROSA PINE IN MERCED, CALIFORNIA

While controlled field trials using otherwise untreated Douglas-fir have provided excellent data for the various chemicals and have demonstrated the comparable performance of these newer systems, it is also desirable to generate data on groundline bandages on in-service poles of other species exposed at alternative sites.

The Merced area in central California was selected for this purpose because it tends to be slightly drier than Corvallis, experiences higher temperatures, and most importantly, the cooperation utility in this area had three wood species available for evaluation.

A total of 27 Douglas-fir, 27 western redcedar, and 15 Ponderosa pine poles was presampled by removing one plug/pole at the groundline. The outer 25 mm of each plug was removed and ground to pass a 20 mesh screen. The resulting powder was analyzed for pentachlorophenol using an Asoma 8620 x-ray fluorescence analyzer. These results were then used to partition the poles into three equal groups so that each group contained poles with similar ranges of preservative retentions.

Poles in a selected group were excavated to a depth of 45 cm and one of three groundline bandage systems was applied according to manufacturer's specifications.

CUNAP® and CuRap20® were the same formulations evaluated on untreated Douglas-fir poles at the Corvallis test site, while Patox II (Osmose Wood Preserving Inc., Buffalo, NY) was a newer formulation containing 70.3% sodium fluoride as the only active ingredient.

The ability of the three formulations to move into the selected wood species was assessed 1-, 2-, 3-, and 5 years after application by removing three increment cores from equidistant points around each pole approximately 15 cm below the groundline. These cores were divided into zones corresponding to 0 to 4, 4 to 10, 10 to 16, and 16 to 24 mm from the wood surface. Samples from the same zone from a respective treatment group were combined prior to grinding to pass a 20 mesh screen. Samples from poles treated with CuRap® or CUNAP WRAP® were analyzed for residual copper content by x-ray fluorescence. Samples treated with boron were analyzed by hot water extraction followed by the Azomethine H method (AWPA, 1995). Samples treated with Patox II were analyzed on a blind sample basis by Osmose Wood Preserving, Inc. using the method described in AWPA Standard A2-94, Method 7 (AWPA, 1995).

Copper levels in Cunap Wrap treated samples continue to decline 7 years after initial application of wraps (**Figure IV-1**). Surface copper levels (0-4 mm) were highest in Douglas-fir and ponderosa pine poles. Copper levels further inward were similar for both of these species but were extremely low in western redcedar. The lower levels in cedar probably reflect the shallow sapwood present in this species. Douglas-fir sapwood ranges from 25 to 75 mm thick, while ponderosa pine has a deep sapwood. Diffusion into the poles is likely to be far better in sapwood. All of copper levels measured fell below the minimum retentions required for initial treatment of poles with copper naphthenate. While the low copper levels may be a concern

in an otherwise untreated sample, the presence of an initial loading of pentachlorophenol coupled with the copper might still provide supplemental protection.

Copper levels in Curap 20 treated samples were markedly higher than those found with Cunap Wrap, although the levels appear to be declining (**Figure IV-2**). Copper levels near the surface were nearly 2 times the minimum retention for copper naphthenate treatment of Douglas-fir poles (1.2 kg/m<sup>3</sup>). Boron levels in Curap 20 treated poles were generally detectable but below the threshold for fungal protection (0.5 % boric acid equivalent) 7 years after treatment. Boron is a water diffusible compound that should be lost relatively easily from the wood, but our result suggest that this loss is relatively slow under the drier conditions typical of this test site. We will continue to monitor chemical levels in these poles to determine how long the boron remains in the wood.

Fluoride levels in Patox II treated poles also declined over the last 2 years (**Figure IV-3**). Fluoride levels in the outer assay zone remained above 0.5 % (wt/wt) in both Douglas-fir and ponderosa pine 7 years after treatment, but were about one half of that level in western redcedar. Fluoride levels declined with increasing distance from the surface in both ponderosa pine and Douglas-fir, but remained constant in cedar. The results indicate that fluoride has become well distributed in the outer pole surface in all three species, although the levels presence near the surface are at or below the levels considered to be a threshold for protection of wood against fungal attack in the absence of an initial treatment. Like the other treatments, however, the fluoride is intended to supplement the initial treatment. Thus, threshold levels may not be necessary for protection since the initial treatment still provides some protection.

We will continue to monitor these tests to determine when retreatment is necessary.

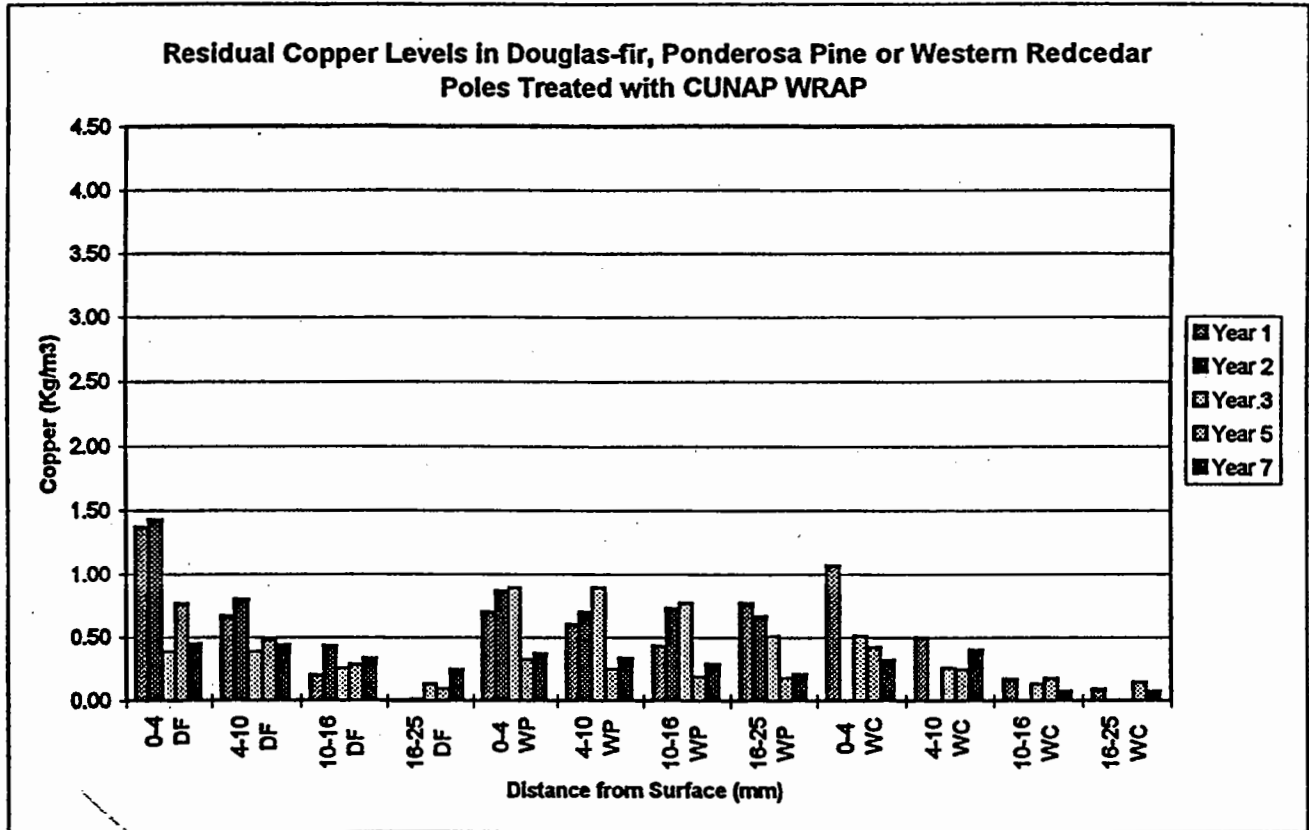

Figure IV-1. Copper levels in at selected distances from the wood surface in the below ground region of Douglas-fir, ponderosa pine, and western redcedar poles 1 to 7 years after application of Cunap wrap

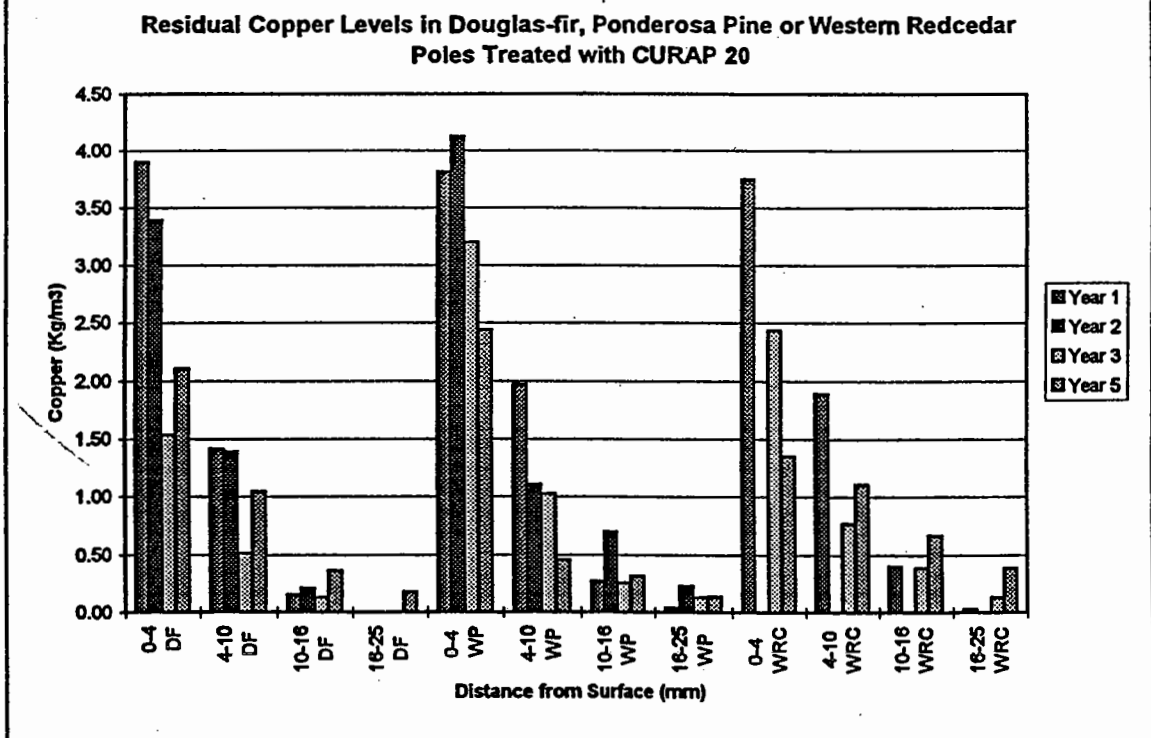
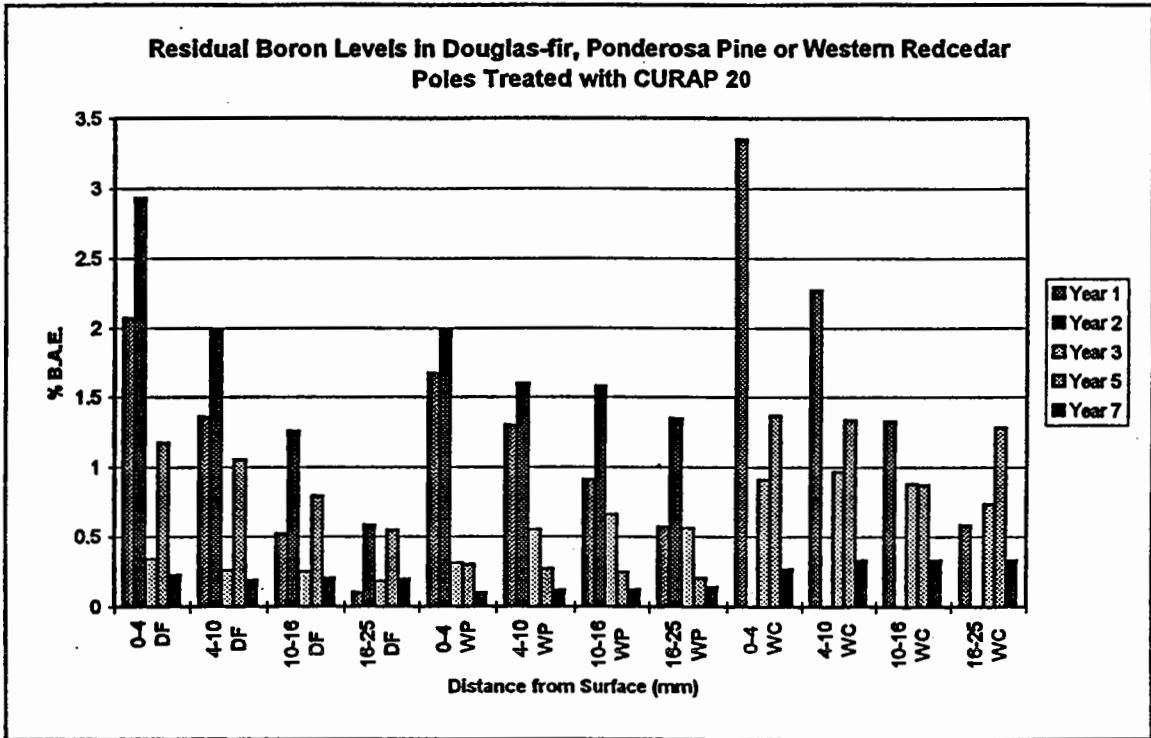

Figure IV-2. Copper and boron levels in at selected distances from the wood surface in the below ground region of Douglas-fir, ponderosa pine, and western redcedar poles 1 to 7 years after application of CuRap 20.

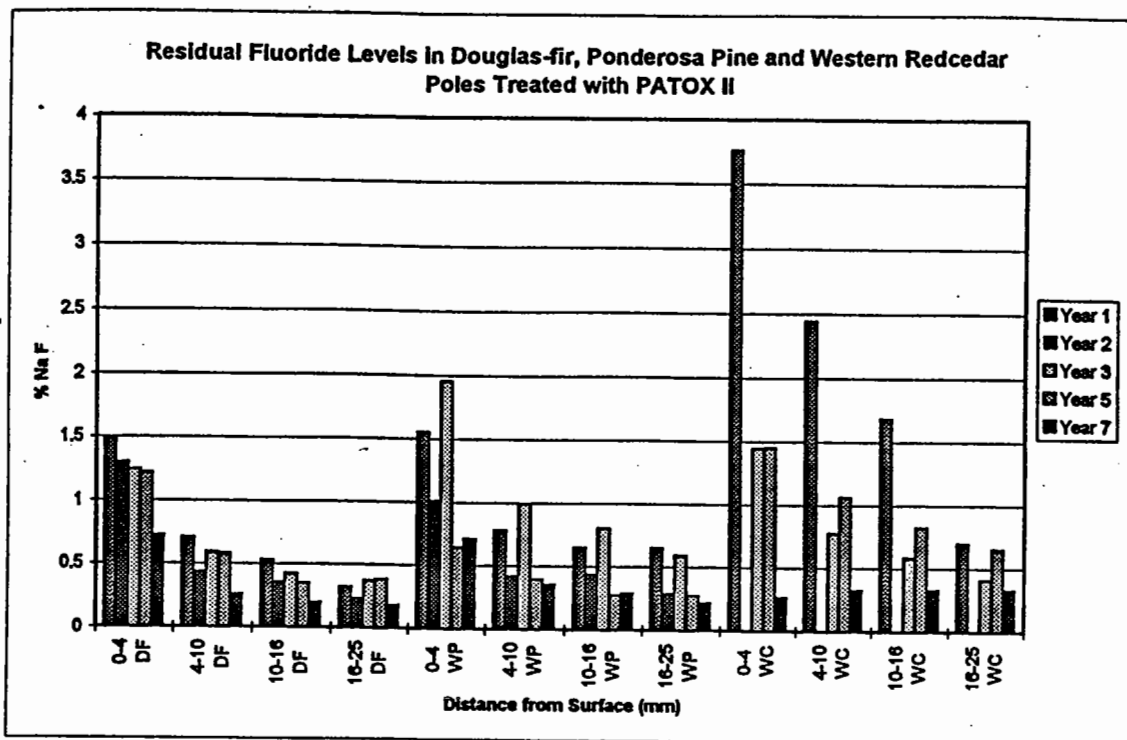

Figure IV-3. Fluoride levels in at selected distances from the wood surface in the below ground region of Douglas-fir, ponderosa pine, and western redcedar poles 1 to 7 years after application of Pattox II.

### B. EVALUATION OF SELECTED GROUNDLINE BANDAGES ON SOUTHERN PINE AND WESTERN REDCEDAR IN BINGHAMTON, NEW YORK.

In order to generate additional data on groundline bandage systems on the southern pine, the species most often receiving this treatment, a field test was established in Binghamton, New York. Western redcedar and southern pine distribution poles ranging in age from 13 to 69 years were treated with CUNAP WRAP<sup>®</sup>, CuRap20<sup>®</sup>, or Pattox II as described earlier (Table IV-1).

The poles were sampled in 1997 with the assistance of NYSEG personnel. The sampling was performed in a manner similar to that used for the California site, where plugs were cut from the poles of three equidistant locations on each pole, 150 mm below the groundline. The cores were cut into zones corresponding to 0 to 4, 4 to 10, 10 to 16, and 16 to 14 mm from the wood surface. Samples from the same

treatment group from a given zone were combined prior to being ground to pass a 20 mesh screen. The resulting material was analyzed for copper, fluoride, or boron as described in Section IV-A.

Chemical levels near the wood surface were generally highest near the wood surface and declined with increasing distance inward. As in the California field test, the boron and fluoride components were more evenly distributed than the copper naphthenate, reflecting the water solubility of the former two compounds (Table IV-2). The initial target retentions for copper naphthenate treatment of southern pine and western redcedar poles are 0.96 and 1.20 kg/m<sup>3</sup>, respectively.

Using these values as guidelines, we can see that the southern pine poles treated with CuRap 20 contained the required level of copper, while those treated with Cunap wrap did not. Western redcedar poles contained lower levels of copper regardless of formulation and neither treatment met the required retention. The lower retentions do not

Table IV. Characteristics of poles used to evaluate groundline preservatives in Binghamton, New York.

OSU #	NYSEG #	Wood Species	Initial Treatment	Class Height	Year Treated	Circumference (in)	Bandage Applied
1	E-33	southern pine	creosote	3-35	1956	32	Osmose
2	E-32	southern pine	pentachloroph enol	5-35	1975	32	Osmose
3	E-31	southern pine	creosote	5-35	1950	32	Osmose
4	E-28	southern pine	creosote	4-35	1942(est)	39	Osmose
5	E-27	southern pine	creosote	4-40	1949(est)	36	Osmose
6	E-26	southern pine	creosote	5-35	1942(est)	30	Osmose
7	E-25	southern pine	creosote	4-40	1942(est)	35	Osmose
8	E-24	southern pine	creosote	4-35	1942(est)	34	CuRap20
9	E-23	southern pine	creosote	4-35	1942(est)	35	CuRap20
10	E-22	southern pine	creosote	5-35	1942(est)	32	CuRap20
11	E-21	southern pine	creosote	5-35	1951	31	CuRap20
12	E-201/2	southern pine	pentachloroph enol	3-45	1984	40	CuRap20
13	E-20	western redcedar	creosote	4-40	1940(est)	39	CuRap20
14	E-19	southern pine	creosote	4-35	1950(est)	27	CuRap20
15	E-18	southern pine	creosote	4-35	1950(est)	32	CuRap20
16	E-17	southern pine	creosote	5-35	1950(est)	31	CuRap20
17	E-16	southern pine	creosote	5-35	1942(est)	28	CuRap20
18	E-151/2	southern pine	creosote	4-40	1950(est)	33	Osmose
19	E-15	southern pine	creosote	4-40	1950(est)	33	Osmose
20	E-14	southern pine	penta	4-40	1975(est)	40	CuRap20
21	E-12	southern pine	creosote	5-35	1950(est)	30	Curap20
22	E-11	southern pine	creosote	4-35	1950(est)	35	CUNAP
23	E-10	southern pine	creosote	4-35	1950(est)	33	CUNAP
24	E-9	southern pine	penta	4-40	1983	35	CuRap20

Table IV. Characteristics of poles used to evaluate groundline preservatives in Binghamton, New York.

OSU #	NYSEG #	Wood Species	Initial Treatment	Class Height	Year Treated	Circumference (in)	Bandage Applied
25	E-7	western redcedar	creosote	2-50	1938(est)	55	Osmose
26	E-8	western redcedar	creosote	2-50	1938(est)	47	CuRap20
27	E-9	western redcedar	creosote	3-50	1938(est)	42	CUNAP
28	E-11	western redcedar	creosote	3-50	1938(est)	48	Osmose
29	E-12	western redcedar	creosote	2-50	1938(est)	52	CUNAP
30	E-13	western redcedar	creosote	3-50	1938(est)	47	CuRap20
31	E-15	western redcedar	creosote	3-45	1938(est)	44	CuRap20
32	1	southern pine	creosote	4-40	1950(est)	35	CuRap20
33	1	southern pine	creosote	4-40	1967	34	CUNAP
34	2	southern pine	creosote	3-40	1967	40	CUNAP
35	3	southern pine	creosote	5-35	1968(est)	32	CUNAP
36	4	southern pine	creosote	5-35	1950(est)	33	CuRap20
37	5	southern pine	creosote	5-35	1937(est)	31	CUNAP
38	6	southern pine	creosote	3-45	1967	38	CUNAP
39	16	western redcedar	creosote	3-45	1938(est)	49	Osmose
40	17	southern pine	creosote	2-50	1965	43	CUNAP
41	18	western redcedar	creosote	3-50	1938(est)	44	CuRap20
42	19	western redcedar	creosote	3-50	1938(est)	50	CUNAP
43	20	western redcedar	creosote	3-50	1938(est)	47	Osmose
44	20A	western redcedar	creosote	3-50	1929(est)	49	CuRap20
45	21	western redcedar	creosote	3-45	1938(est)	44	CUNAP
46	22	western redcedar	creosote	3-45	1938(est)	41	Osmose
47	24	western redcedar	creosote	3-45	1938(est)	44	CuRap20
48	25	southern pine	penta	2-50	1976	45	CUNAP
49	27	southern pine	penta	5-35	1955	31	CuRap20
50	28	southern pine	penta	4-40	1985	36	CUNAP

necessarily mean that the treatment will fail since the poles also contain the residual levels of the initial treatment chemical (either creosote or penta). Boron levels in the outer 2 sampling zones were above the threshold for fungal growth (0.5 % BAE) for both southern pine and western redcedar and were above that level 10 to 15 mm from the surface in southern pine. Boron levels in the 2 inner zones were lower in western redcedar, perhaps reflecting the shallow sapwood in this species and a slower rate of diffusion through heartwood. Fluoride levels in Patox II treated samples were well above the threshold in the outer zone and declined steadily with distance from the surface. Once again, fluoride levels in the inner 2 zones were much lower in western redcedar.

The results indicate that all three paste components are performing in a manner similar to that found in the California site. The tendency for the paste components to move at slightly lower rates in western redcedar probably does not pose a concern since the wood in the inner zones is most likely heartwood which already exhibits some resistance to microbial attack. These poles will be sampled in the coming year to establish a more complete performance record on these wood species.

### **C. PERFORMANCE OF COPPER AND PROPICONAZOLE BASED PASTES ON DOUGLAS-FIR POLE SECTIONS**

Last year, we reported on the movement of a propiconazole based groundline paste through Douglas-fir heartwood blocks maintained at selected wood moisture contents.

These results encouraged us to establish a large scale field test.

Forty Douglas-fir poles sections (250 to 300 mm in diameter by 1.6 m long) were set to a depth of 0.6 m at the Peavy Arboretum test site. The site was slightly uphill from the test site that was used for the earlier groundline wrap test in an attempt to avoid the high water table that characterized the earlier test site. The posts were treated with a propiconazole based paste (Janssen Pharmaceutica), a copper/fluoride/boron based wrap (Dr. Wolman GmbH), or CuRap 20 (ISK BioSciences). The posts were treated by coating the zone from slightly above the groundline to 300 mm below that zone with a 5 mm thick layer of a paste containing 1% propiconazole. The paste was then covered with a Bell Labs Kraft paper/plastic wrap to retain chemical and limit microbial colonization of the wood surface. The surrounding soil was then replaced around the pole sections. Propiconazole was applied to 7 poles, the Cu/F/B paste was applied to 15 sections, and the CuRap was applied to 5 sections. These sections will be examined for propiconazole, copper, fluoride or boron migration in a manner similar to that used for the New York and California test sites. In addition, selected Cu/ F/B sections will be dissected at periodic intervals after treatment and stained with the appropriate indicators to detect movement of each paste component into the wood.

#### **Outcomes of this Objective**

- ▶ Reformulated groundline bandages are performing similarly to earlier systems.
- ▶ Boron is most susceptible to loss, although rate of loss varies with site conditions.



Table IV-2. Residual copper, fluoride or boron at selected distances from the surface below the groundline of southern pine and western redcedar poles 2 years after application of CuRap20, Cunap Wrap or Patox II.

Distance from wood surface (mm)	CuRap 20				Cunap Wrap			Patox II	
	Southern pine		W. redcedar		Southern pine	W. redcedar	Southern pine	W. redcedar	
	% BAE	Cu (kg/m <sup>3</sup> )	%BAE	Cu (kg/m <sup>3</sup> )	Cu (kg/m <sup>3</sup> )	Cu (kg/m <sup>3</sup> )	NaF (%)	NaF (%)	
0 to 4	0.82 (0.69)	1.90 (1.38)	0.81(0.57)	1.10 (1.00)	0.54 (0.26)	0.56 (0.53)	1.30 (0.59)	0.81 (0.27)	
4-10	0.60 (0.29)	0.94 (0.77)	0.68 (0.45)	0.34 (0.37)	0.20 (0.11)	0.44 (0.33)	0.84 (0.39)	0.49 (0.16)	
10-15	0.53 (0.28 )	0.42 (0.26)	0.36 (0.19)	0.10 (0.09)	0.11 (0.09)	0.32 (0.22)	0.73 (0.40)	0.48 (0.22)	
15-25	0.35 (0.12)	0.19 (0.12)	0.12 (0.07)	0.03 (0.02)	0.05 (0.05)	0.26 (0.19)	0.64 (0.45)	0.34 (0.08)	

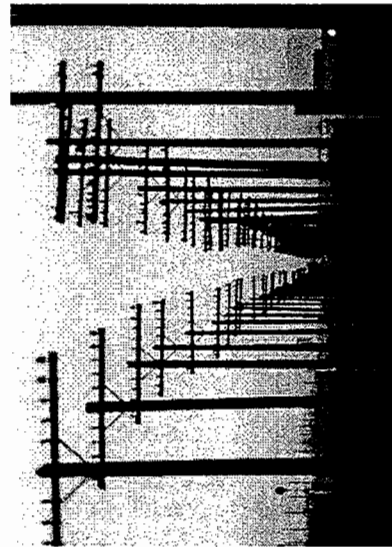

# OBJECTIVE V

## PERFORMANCE OF COPPER NAPHTHENATE-TREATED WESTERN WOOD SPECIES

### A. DECAY RESISTANCE OF COPPER NAPHTHENATE-TREATED WESTERN RED-CEDAR IN A FUNGUS CELLAR

The naturally durable heartwood of western redcedar makes it a preferred species for supporting overhead utility lines. For many years, utilities used cedar without treatment or only treated the butt portion of the pole to protect the high hazard ground contact zone. The cost of cedar, however, encouraged many utilities to full-length treat their cedar poles. While most utilities use either pentachlorophenol or creosote for this purpose, there is increasing interest in alternative chemicals. Among these chemicals is copper naphthenate, a complex of copper and naphthenic acids derived from the oil refining process. Copper naphthenate has been in use for many years, but its performance as an initial wood treatment for poles remains untested on western redcedar.

Copper naphthenate performance on western redcedar was evaluated by cutting sapwood stakes (12.5 by 25 by 150 mm long) from either freshly sawn boards or from the aboveground, untreated portion of poles which had been in service for about 15 years. Weathered stakes were included because of a desire by the cooperators to retreat cedar poles for reuse. In prior trials, a large percentage of cedar poles removed from service due to line upgrades were found to be serviceable and the utility wanted to recycle these in their system. The stakes were conditioned to 13% moisture content prior to pressure treatment with copper naphthenate in diesel oil to produce retentions of 0.8, 1.6, 2.4, 3.2, and 4.0 kg/m<sup>3</sup>. Each retention was replicated on ten stakes.

The stakes were exposed in a fungus cellar maintained at 28°C and approximately 80% relative humidity. The soil was a garden loam

with a high sand content. The original soil was amended with compost to increase the organic matter. The soil is watered regularly, but is allowed to dry between waterings to simulate a natural environment. The condition of the stakes has been assessed annually on a visual basis using a scale from 0 (failure) to 10 (sound).

The samples continue to follow the same trends noted last year (Table V-1). The weathered samples continue to deteriorate at a slightly faster rate than the non-weathered samples, although both sets of stakes treated to the ground contact retentions with copper naphthenate remain sound. Non-weathered stakes treated with diesel alone continue to remain serviceable, while weathered stakes treated with diesel alone have failed. The results continue to demonstrate that the recommended retention levels of copper naphthenate will perform well on western redcedar.

### B. EVALUATION OF COPPER NAPHTHENATE TREATED DOUGLAS-FIR POLES IN SERVICE

In recent years, there have been a number of reports of early failures of copper naphthenate treated southern pine poles. These reports have been surrounded by litigation that limited the amount information available to other utilities and made it difficult to judge whether the failures were the result of poor handling practices or resistance to the preservative.

Copper naphthenate has been used to a limited extent on the west Coast since 1988 to treat Douglas-fir poles with no reports of early failures. Since treatment practices differ substantially between southern pine and Douglas-fir, and since the performance characteristics of these species also vary widely, we elected to survey copper naphthenate treated Douglas-fir poles within Oregon and California.

The poles in Oregon were inspected by removing increment cores from locations 75 mm below and 300 mm above the groundline. The cores were divided into zones corresponding to - to 13, 13 to 25, 25 to 38, 38 to 51, 51 to 64, 64 to 76 and 76 to 102 mm from the wood surface. The zones from a given set of cores were combined prior to grinding to pass a 20 mesh screen. The resulting wood meal was analyzed for copper using an ASOMA 8620 x-ray fluorescence analyzer using the CCA-wood mode. The resulting number should be viewed with some caution since the copper in the copper naphthenate/oil matrix may differ from that found in CCA, leading to potential analytical errors, but the results should provide a relative guide to the levels of copper present in the wood. A total of 24 poles were inspected in Oregon in 1997. The poles had all been radially drilled in the groundline zone prior to treatment. In addition, 42 poles were inspected in 1998 and the results of the latter assays will be reported in the next annual report.

The analyses from the first 24 poles showed that copper levels were generally above the levels required by the American Wood Preservers' Association Standard C4 for copper naphthenate treatment of Douglas-fir poles in both the outer and inner zones (**Figure V-1-5**). The exceptions were the above ground portion of one 3 pole sample from Tangent, Oregon. In general, copper levels tended to be slightly lower 300 mm above ground than in the below ground sample. These differences suggest that some downward migration of preservative had occurred. Such migration would be beneficial since higher levels of copper in the soil contact zone are far more critical than elevated copper above the groundline.

The second sample of copper naphthenate treated poles were located in California. Increment cores were removed from 3 locations 30 and 120 mm above the groundline in Cool (5 poles), Nicholas (3 poles), and San Ramon (1 pole). All were installed in 1988. In addition, one pole treated with copper naphthenate in liquified petroleum gas (Cellon) was inspected in

San Ramon and 15 Cellon treated poles were inspected at Booneville. None of the poles was through bored or radially drilled prior to treatment. As expected, copper levels generally declined rapidly with increasing depth from the surface (**Figure V-6-10**). Copper levels were at or below the initial retention requirement in the Nicholas and San Ramon poles. Copper levels in poles from the Cool site were slightly above the minimum in the outer zone and at or below the minimum 13 to 25 mm below the surface. Copper levels in both sets of Cellon treated poles were well above the minimum retention in the outer 25 mm and were still above that levels 25 to 38 mm from the surface.

Copper levels were similar 300 and 1200 mm above the groundline, suggesting relatively little redistribution of preservative had occurred in these zones. In addition, comparisons with previous analyses indicate that there has been little or no change in copper levels in poles from Cool or Booneville (**Figure V-11-12**). The absence of consistent differences in retention between the heights in the Cellon treated poles is not surprising since there is little or no solvent to migrate downward in these poles, but the absence of a difference in the oil treated poles differs from that found in Oregon.

Culturing of increment cores removed from the poles revealed that both groundline cores from 2 poles contained viable decay fungi. Both of these poles were Cellon treated (**Table V-2**). None of the other cores contained viable decay fungi although many contained non-decay fungi. None of the cores exhibited any evidence of decay.

The results suggest that the oilborne copper naphthenate treated Douglas-fir poles in both California and Oregon are performing well with little or no evidence of either excessive preservative loss or fungal attack. We will continue to monitor copper naphthenate poles to ensure that they are performing as expected.

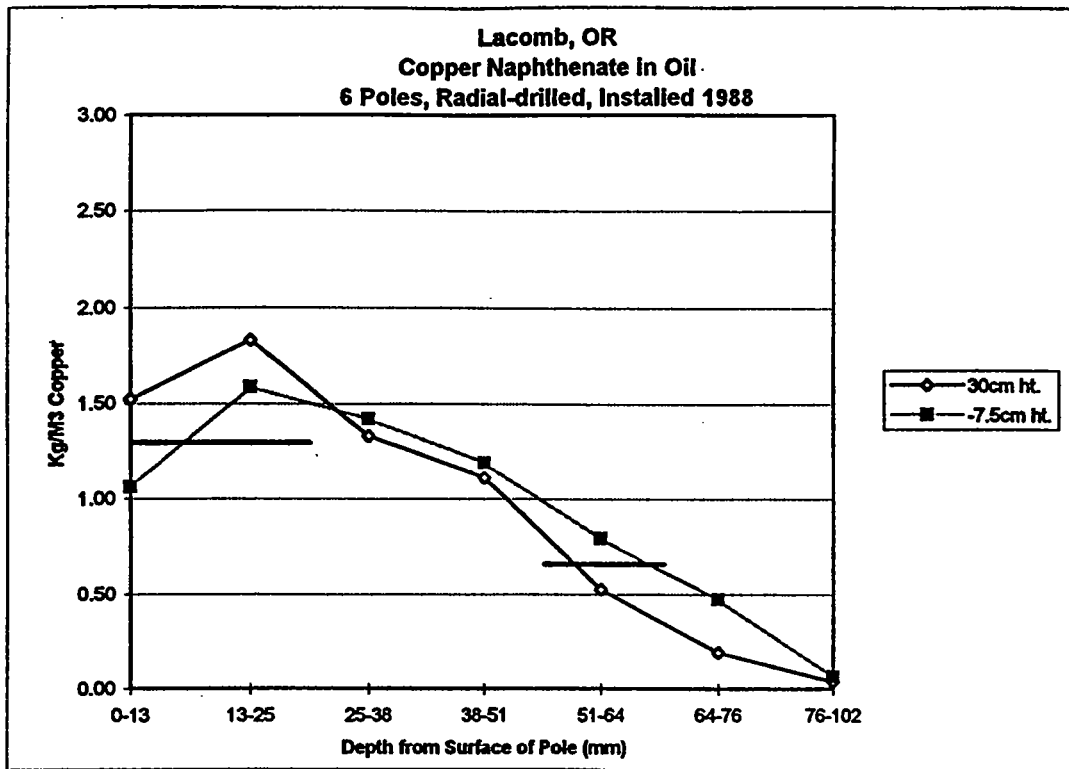

Figure V-1. Copper levels at selected depths in six radially-drilled copper naphthenate-treated Douglas-fir poles 10 years after installation in Lacomb, Oregon.

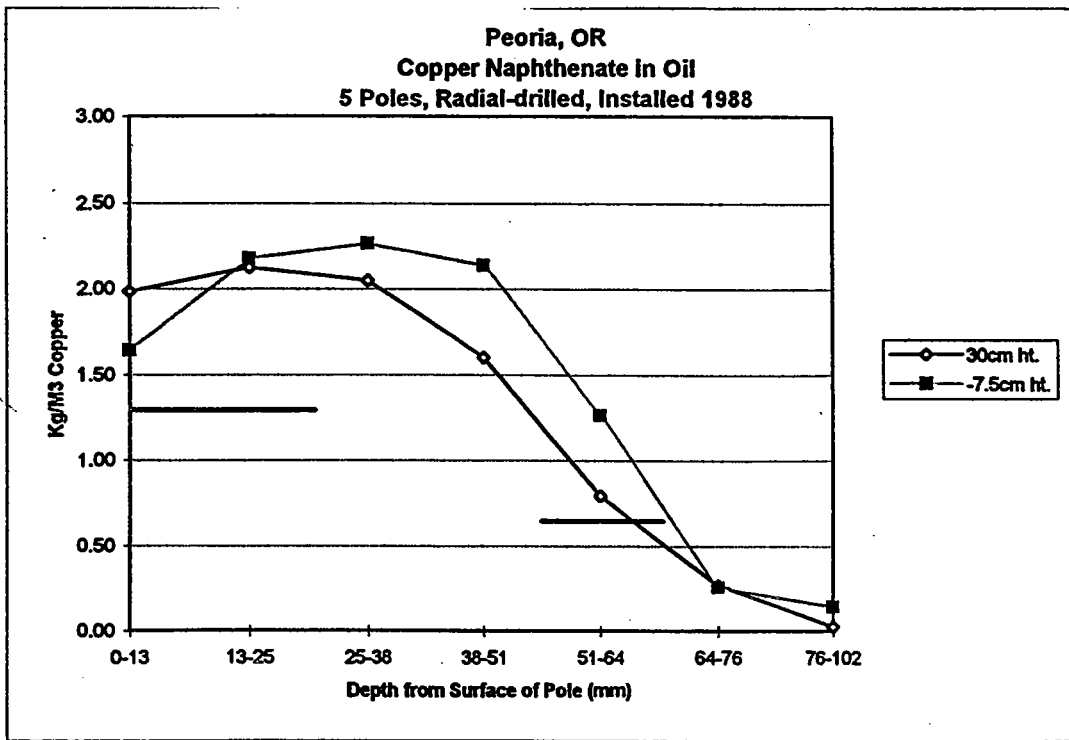

Figure V-2. Copper levels at selected depths in five radially-drilled copper naphthenate-treated Douglas-fir poles 10 years after installation in Peoria, Oregon.

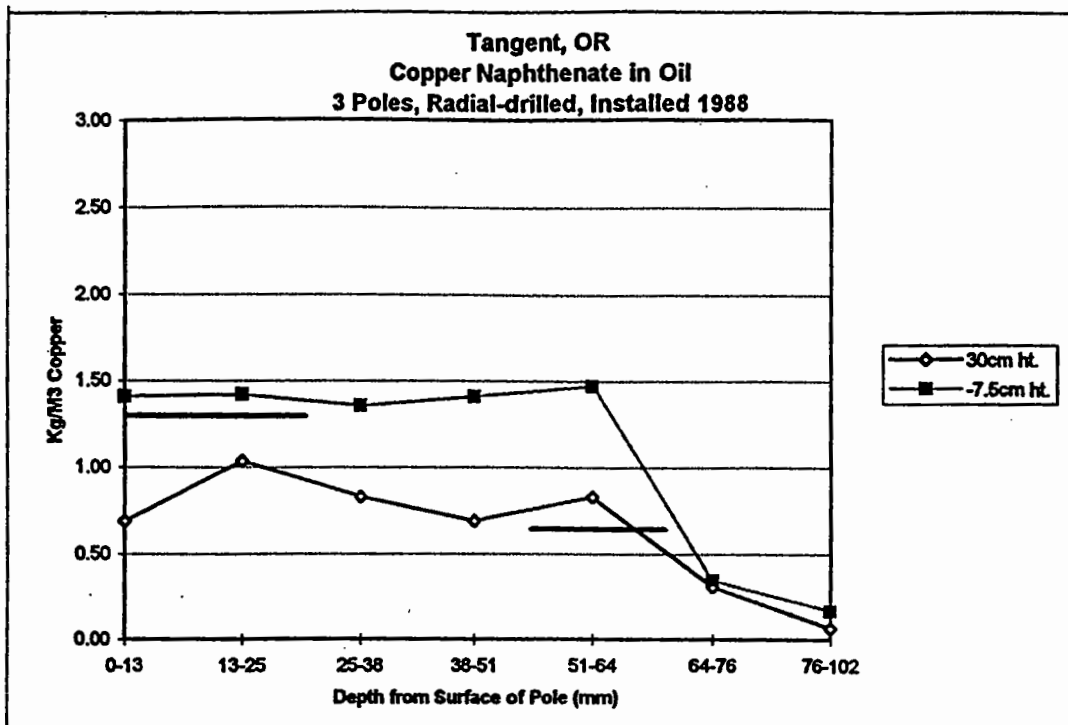

Figure V-3. Copper levels at selected depths in three radially-drilled copper-naphthenate treated Douglas-fir poles 10 years after installation in Tangent, Oregon.

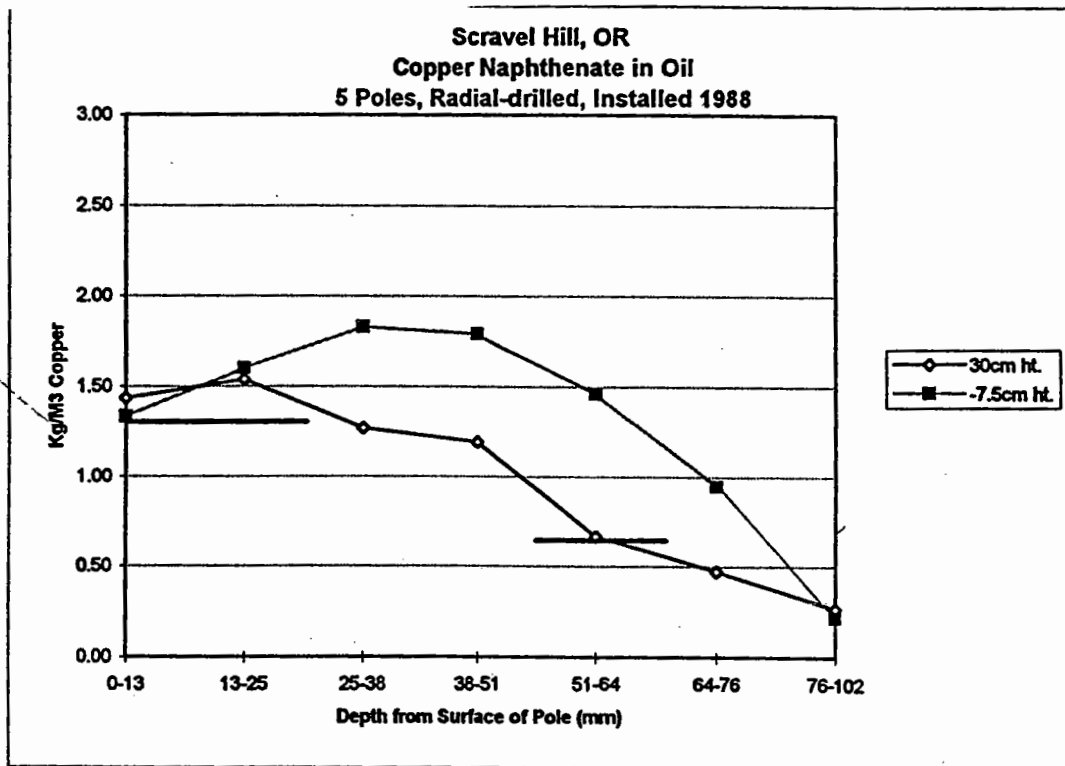

Figure V-4. Copper levels at selected depths in five radially-drilled copper naphthenate-treated Douglas-fir poles 10 years after installation in Scrael Hill, Oregon.

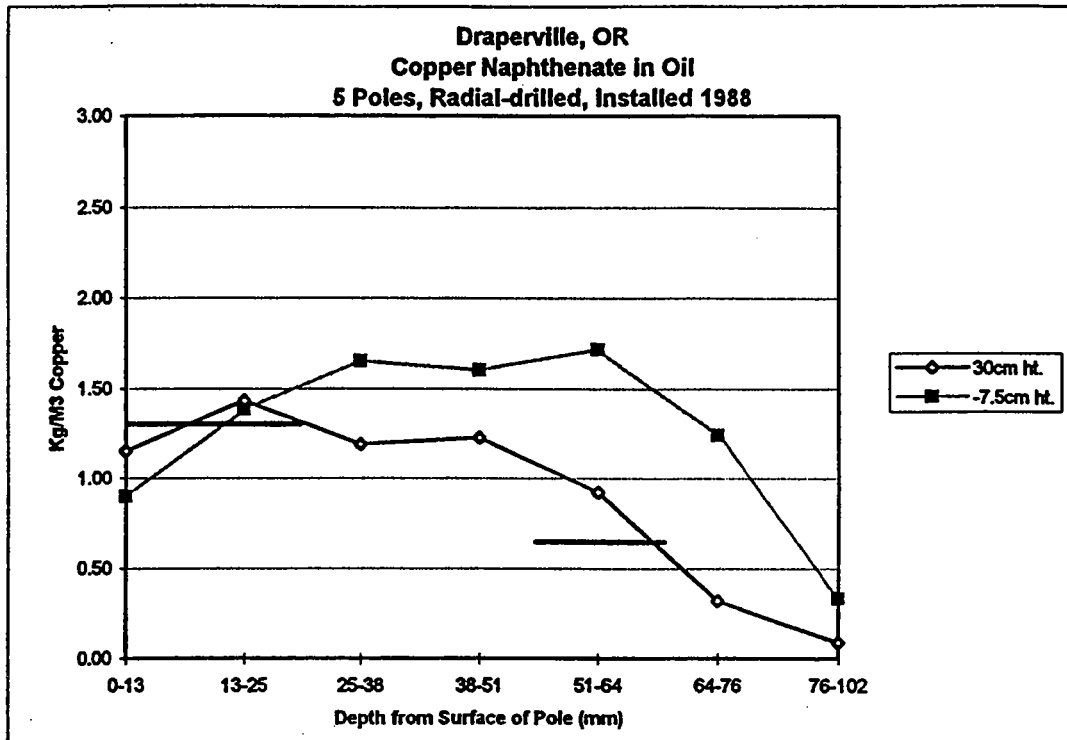

Figure V-5. Copper levels at selected depths in five radially-drilled copper naphthenate-treated Douglas-fir poles 10 years after installation in Draperville, Oregon.

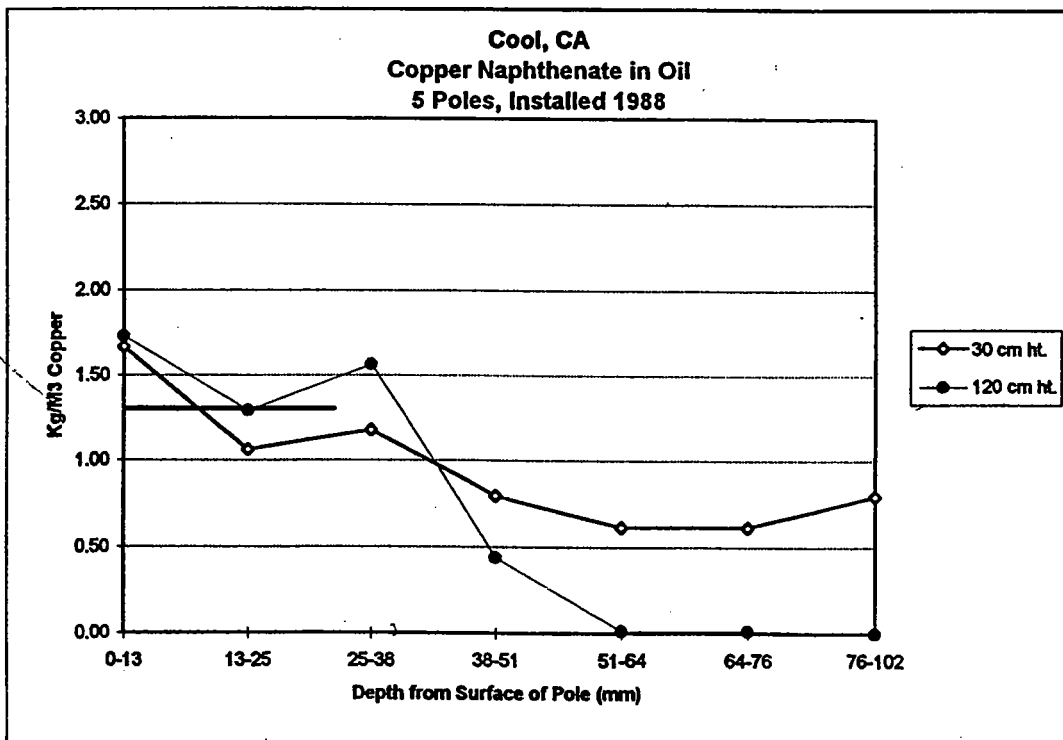

Figure V-6. Copper levels at selected depths in five copper naphthenate-treated Douglas-fir poles 10 years after installation in Cool, California.

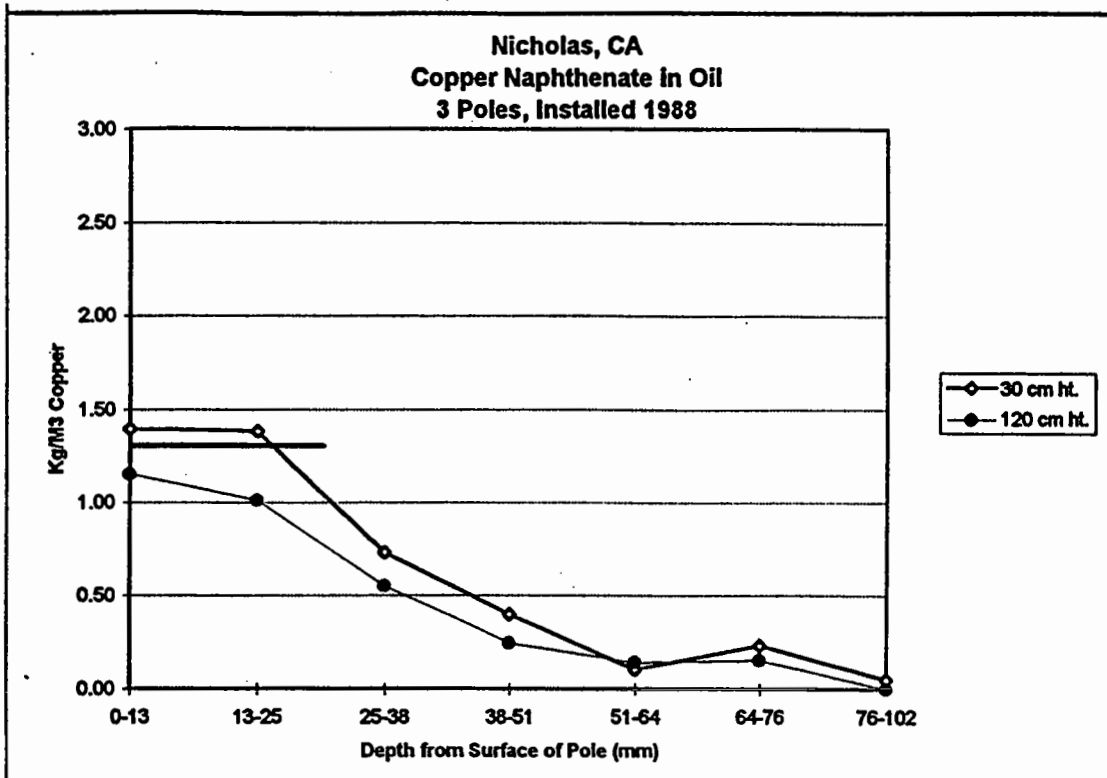

Figure V-7. Copper levels at selected depths in three copper naphthenate-treated Douglas-fir poles 10 years after installation in Nicholas, California.

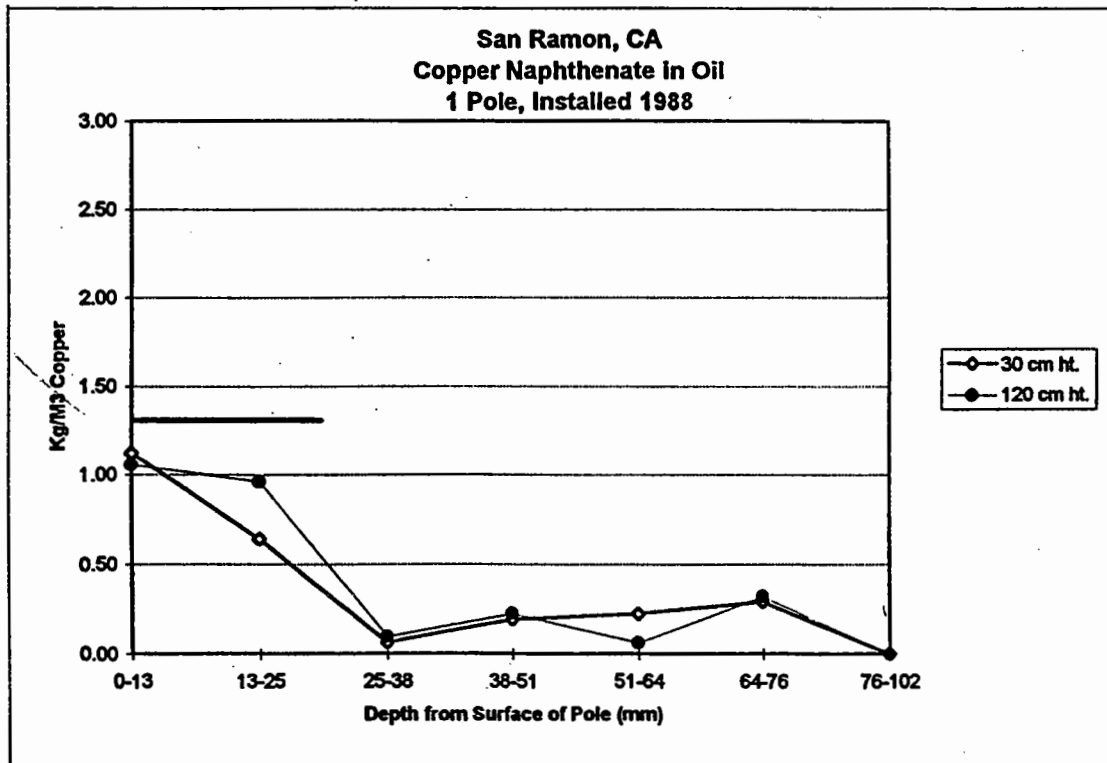

Figure V-8. Copper levels at selected depths in one copper naphthenate-treated Douglas-fir poles 10 years after installation in San Ramon, California.

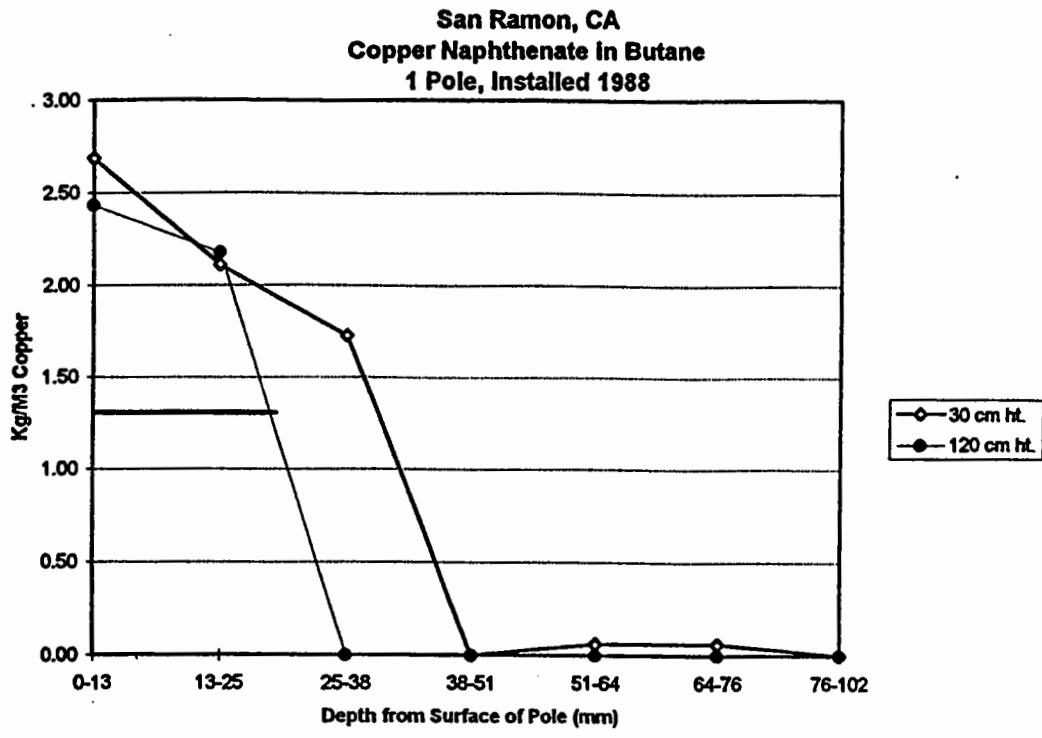

Figure V-9. Copper levels at selected depths in one copper naphthenate in liquified petroleum gas-treated Douglas-fir pole 10 years after installation in San Ramon, California.

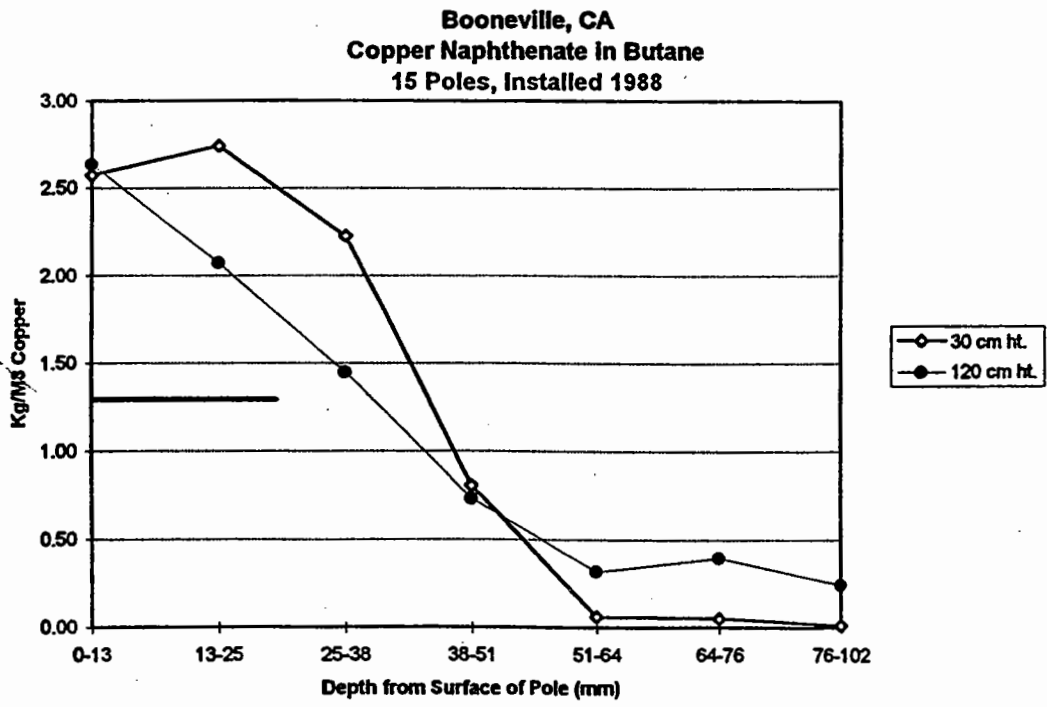

Figure V-10. Copper levels at selected depths in 15 copper naphthenate in liquified petroleum gas-treated Douglas-fir poles in Booneville, California.



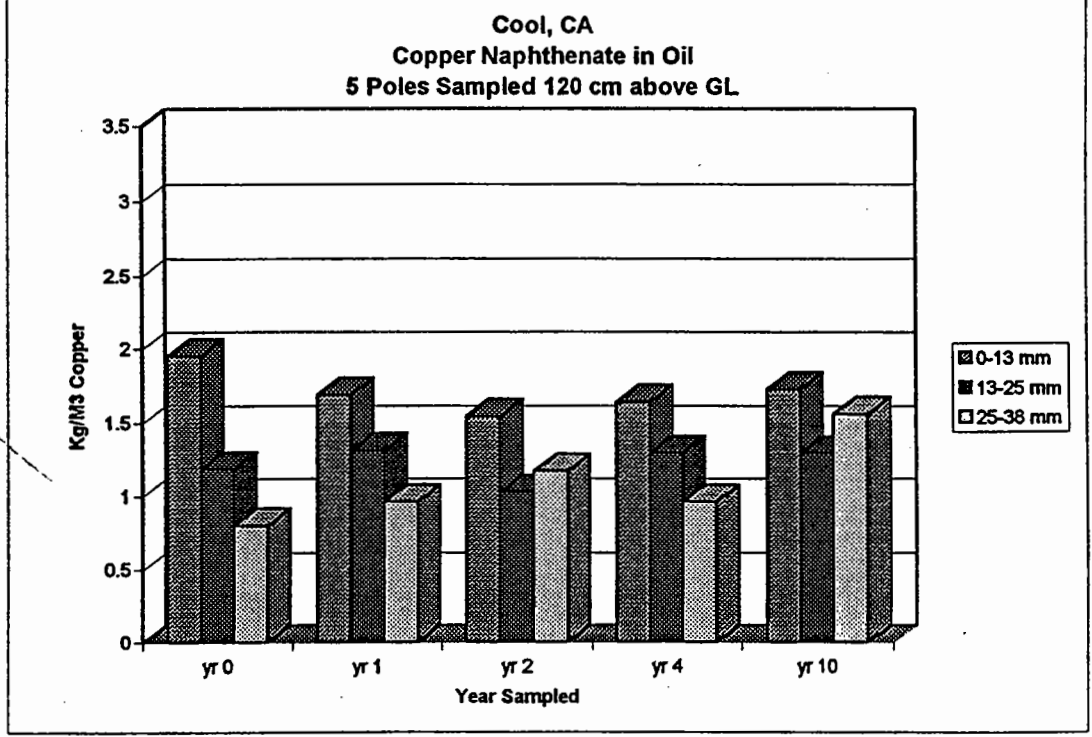
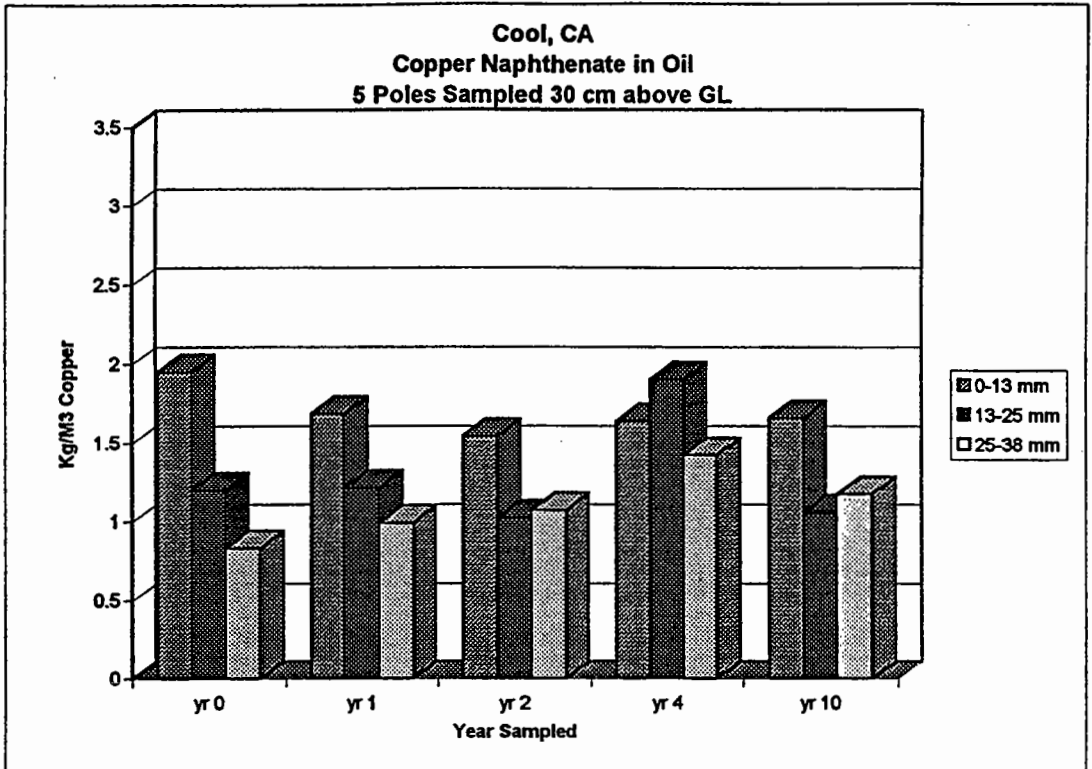

Figure V-11. Copper levels a) 30 or b) 120 cm above the groundline at selected distances from the wood surface of copper naphthenate-treated Douglas-fir poles 0 to 10 years after installation in Cool, California.

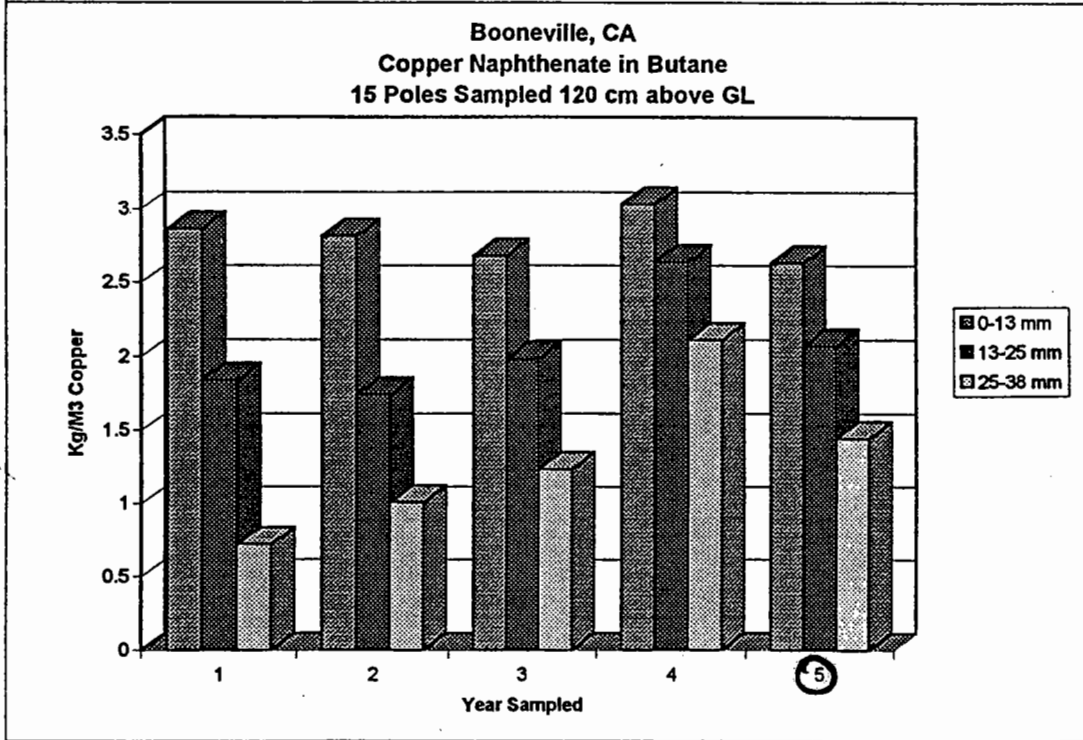
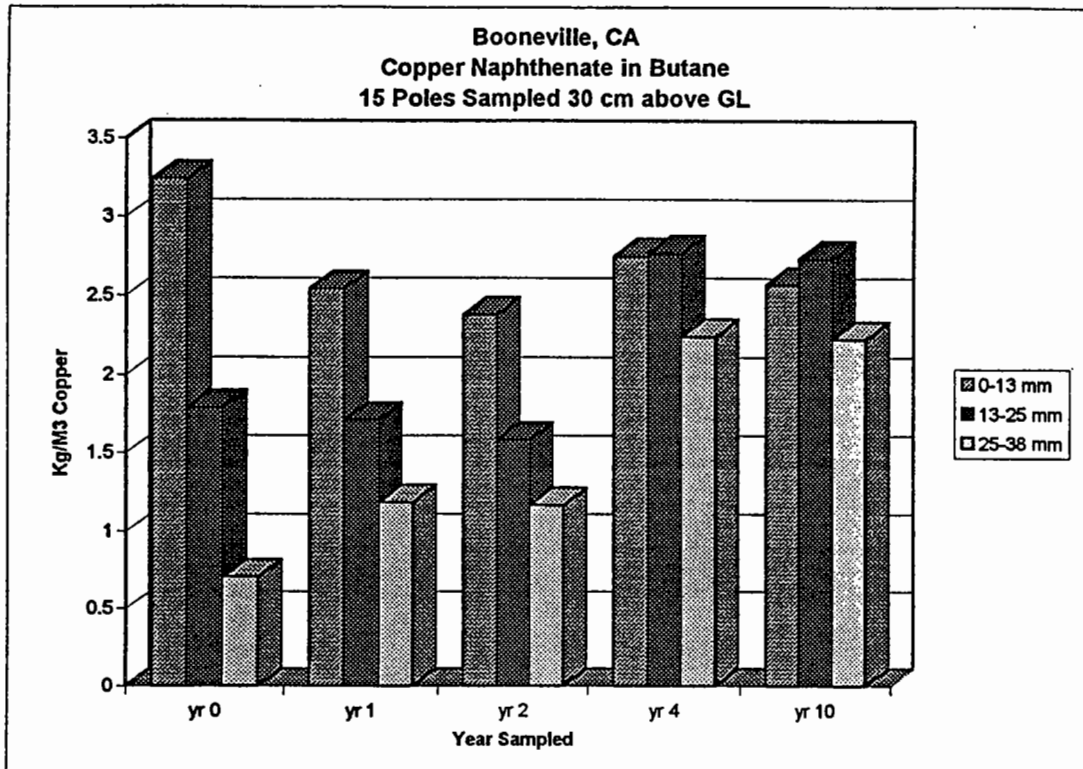

Figure V-12. Copper levels a) 30 or b) 120 cm above the groundline at selected distances from the wood surface of copper naphthenate treated Douglas-fir poles 0 to 10 years after installation in Booneville, California.

Table V-2. Isolation frequency of decay fungi and non-decay fungi from copper naphthenate-treated Douglas-fir poles in California, 10 years after installation.

Site	Pole Numbers	Solvent	Fungal Frequency (%)			
			Distance from Groundline (mm)			
			100mm	300 mm	600 mm	1200 mm
Booneville	1	butane	100 <sup>0</sup>	-	-	-
Booneville	2	butane	0 <sup>0</sup>	-	-	-
Booneville	3	butane	0 <sup>0</sup>	-	-	-
Booneville	4	butane	0 <sup>0</sup>	-	-	-
Booneville	5	butane	0 <sup>0</sup>	-	-	-
Booneville	9	butane	0 <sup>0</sup>	-	-	-
Booneville	10	butane	0 <sup>0</sup>	-	-	-
Booneville	11	butane	0 <sup>0</sup>	-	-	-
Booneville	12	butane	0 <sup>100</sup>	-	-	-
Booneville	14	butane	0 <sup>100</sup>	-	-	-
Booneville	15	butane	0 <sup>50</sup>	-	-	-
Booneville	16	butane	0 <sup>0</sup>	-	-	-
Booneville	18	butane	100 <sup>0</sup>	-	-	-
Booneville	20	butane	0 <sup>0</sup>	-	-	-
Booneville	21	butane	0 <sup>50</sup>	-	-	-
San Ramon	15	butane	0 <sup>0</sup>	0 <sup>0</sup>	0 <sup>0</sup>	0 <sup>0</sup>
Cool	1	oil	0 <sup>100</sup>	-	-	-
Cool	2	oil	0 <sup>50</sup>	-	-	-
Cool	3	oil	0 <sup>50</sup>	-	-	-
Cool	4	oil	0 <sup>100</sup>	-	-	-
Cool	6	oil	0 <sup>50</sup>	-	-	-
Nicholas	1	oil	0 <sup>100</sup>	-	-	-
Nicholas	2	oil	0 <sup>50</sup>	-	-	-
Nicholas	3	oil	0 <sup>100</sup>	-	-	-
San Ramon	13	oil	0 <sup>0</sup>	0 <sup>0</sup>	0 <sup>0</sup>	0 <sup>33</sup>

Values represent percent of cores containing decay fungi. Superscripts represent percent of non-decay fungi present in same cores. Values represent averages of two samples at 10 cm and three samples at other heights. Poles at San Ramon were remedially treated with three vials of MITC-fume in 1993.

Table V-1. Condition of western redcedar sapwood stakes treated to selected retentions with copper naphthenate in diesel oil and exposed in a soil bed for 6 to 100 months.

Target Retention <sup>1</sup> (kg/m <sup>3</sup> )	Weathered Samples										New Samples											
	Actual Retention (kg/m <sup>3</sup> )					Average Decay Rating <sup>2</sup>					Actual Retention (kg/m <sup>3</sup> )	Average Decay Rating <sup>2</sup>					Actual Retention (kg/m <sup>3</sup> )	Average Decay Rating <sup>2</sup>				
	6 mos	14 mos	26 mos	40 mos	52 mos	64 mos	76 mos	88 mos	100 mos	6 mos		14 mos	26 mos	40 mos	52 mos	64 mos		76 mos	88 mos	100 mos		
Control	4.7	0.9	0.4	0.1	0	0	0	0	0	0	—	6.6	3.2	1.3	1.1	1.1	1.0	0.9	0.5	0.4		
diesel	8.5	6.8	5.3	3.8	3.4	3.4	2.0	1.4	0.8	—	9.9	8.4	8.0	8.6	8.4	8.0	8.0	7.7	7.3	7.3		
0.8	9.0	8.0	7.5	6.9	5.7	5.6	5.3	5.1	4.8	0.8	10.0	9.6	9.4	9.5	9.6	9.3	9.3	9.3	9.3	9.5		
1.6	9.5	8.9	8.8	9.0	8.0	7.8	7.4	7.3	6.8	1.5	10.0	9.4	9.3	9.2	9.4	9.1	9.2	9.2	9.2	9.5		
2.4	9.6	9.2	9.1	8.6	8.2	8.2	7.9	7.7	6.8	1.9	10.0	9.4	9.4	9.2	9.3	9.2	9.1	9.1	9.1	9.5		
3.2	9.6	9.1	9.0	8.8	8.1	8.1	8.1	8.1	8.0	2.6	10.0	9.2	9.2	9.0	8.9	8.9	9.1	9.1	9.1	9.5		
4.0	9.9	9.2	9.1	9.1	8.7	8.3	8.2	8.2	8.0	3.4	10.0	9.5	9.4	9.4	9.3	9.2	9.2	9.2	9.2	9.4		

<sup>1</sup> Retention measured as (kg/m<sup>3</sup>) (as copper).

<sup>2</sup> Values represent averages of 10 replicates pretreatment, where 0 signifies completely destroyed and signifies no fungal attack.



## Literature Cited

American Institute of Timber Construction. 1994. Timber Construction Manual. John Wiley and Sons, New York. 904 pp.

American Society for Testing and Materials. 1996. Standard methods of static tests of lumber in structural sizes. ASTM D 198. *In: Annual Book of ASTM Standards, Vol. 04.10.* ASTM, West Conshohocken, Pa. pp. 57-71.

American Society for Testing and Materials. 1996b. Standard practice for evaluating allowable properties for grades of structural lumber. ASTM D 2915. *In: Annual Book of ASTM Standards, Vol. 04.10.* ASTM, West Conshohocken, Pa. pp. 397-408.

American Wood Preservers' Association. 1996a. Standard A2 Analysis of waterborne preservatives and fire retardants formulations. Methods 16. Determination of boron in treated wood using azornethine-H or carminic acid. *In: Book of Standards, AWPA, Granbury, TX.* Pages 147-148.

American Wood Preservers' Association. 1996b. Standard E10-91. Standard method of testing wood preservatives by laboratory soil-block cultures. *In: Book of Standards, AWPA, Granbury, TX.* Pages 305-315.

American Wood-Preservers' Association. 1996c. Standard M1-96. Standard for the purchase of treated wood products. *Book of Standards. AWPA, Stevensville, Md.* pp. 229-231.

Carey, J.K. and A.F. Bravery. 1987. A technique for determining the efficacy of water diffusible preservative plugs for implanting in joinery in service. International Research Group on Wood Preservation Document No. IRG/WP/2291. Stockholm, Sweden. 12 pages.

Cockcroft, R. and J.F. Levy. 1973. Bibliography on the use of boron compounds in the preservation of wood. *Journal Institute of Wood Science* 6(3):28-37.

Coe, R.N. 1967. Symposium on pole line appearance. *In: Proceedings of the American Wood-Preservers' Association, Vol. 63.* AWPA, Washington, D.C. pp. 46-60.

Cserjesi, A.J. and G.W. Swann. 1969. A sub-surface inoculation technique for study of boron-diffusion treatment to arrest incipient decay in wood. *Bi-Monthly Research Notes, Canadian Forest Service, Ottawa, Canada.* Volume 25(2):13-15.

Davies, D.L. 1971. Durability of poles treated with penta in an LP gas system. *In: Proceedings of the American Wood-Preservers' Association, Vol. 67.* AWPA, Washington, D.C. pp. 37-46.

deJonge, J.T. 1986. The efficacy of boron preparations. International Research Group on Wood Preservation Document No. IRG/WP/3400. Stockholm, Sweden. 7 pages.

Electric Power Research Institute, 1990. Pentachlorophenol (PCP)-treated wood poles and crossarms: toxicity characteristic leaching procedure (TCLP) results. Prepared by Environmental Management Services, EPRI EN-7062, Interim Report.

Findlay, W.P.K. 1959. Boron compounds for the preservation of timber against fungi and insects. Proceedings, German Wood Research Association 6<sup>th</sup> Wood Protection Congress, Hamburg. 8 pages.

Findlay, W.P.K. 1953. The toxicity of borax to wood-rotting fungi. Timber Technology 61(No. 2168):275-277.

Goodrich-Mahoney, J. 1992. TCLP test date on utility pole and crossarms treated with penta and creosote. IN: Treated Wood Life-Cycle Management Workshop Proceedings. American Wood Preservers' Institute, Vienna, Virginia, pages 195-213.

Graham, R.D. 1983. Improving the performance of wood poles. Proceedings American Wood-Preservers' Association 79:222-228.

Graham, R.D. and E.M. Estep. 1966. Effect of incising and saw kerfs on checking of pressure-treated Douglas-fir spar crossarms. Proceedings, American Wood Preservers' Association 62:155-158.

Hand, O.F. and P. Lindgren. 1975. Durability of Cellon treated Douglas-fir and distribution of Cellon pentachlorophenol in Douglas-fir poles. Tech. Rep. ERGA 75-6. Branch of Laboratories, Bonneville Power Administration, Vancouver, Wash. 24 pp.

Hartford, W. 1973. Chemical and physical properties of wood preservatives and wood-preservative systems. Wood Deterioration and its Prevention by Preservative Treatments. Vol. II. D.D. Nicholas, ed. Syracuse University Press, Syracuse, N.Y. pp. 1-120.

Helsing, G.G. and R.D. Graham, 1981. Control of wood rot in waterfront structures. Program SG55. Extension Marine Advisory, Oregon State Univ., Corvallis, Oreg.

Helsing, G.G. and R.D. Graham. 1976. Saw kerfs reduce checking and prevent internal decay in pressure-treated Douglas-fir poles. *Holzforschung* 30(6):184-186.

Helsing, G.G., J.J. Morrell, and R.D. Graham. 1986. Service life of Douglas-fir piles: methods for protecting cut-off tops from decay. *Forest Products Journal* 36(2):21-24.

Hernandez, R., R.C. Moody, and R.H. Falk. 1995. Fiber stress values for design of glulam timber utility structures. Res. Pap. FPL-RP-532. USDA Forest Serv., Forest Prod. Lab., Madison, Wis. 23 pp.

Hess, R. 1988. Handling and disposal practices of northwest utilities. IN: Proceedings Wood Pole Conference, Northwest Electric Light and Power Association, Portland, Oregon, pages 26-27.

Highley, T.L. 1984. In-place treatments from waterborne preservatives for control of decay in hardwoods and softwoods above ground. *Material und Organismen* 19(2):95-104.

Highley, T.L. 1983. Protecting piles from decay: End treatments. *Int. J. Wood Preserv.* 3(2):73-76.

Highley, T.L. 1980. In-place treatments for control of decay in waterfront structures. *Forest Products Journal* 30(9):49-51.

Highley, T.L. and T.C. Scheffer. 1978. Controlling decay in above-water parts of waterfront structures. *Forest Products Journal* 28(2):40-43.

Highley, T.L. and T.C. Scheffer. 1975. In-place treatment of simulated waterfront structures for decay control. *Material und Organismen* 10:57-66.

Institute of Electrical and Electronic Engineers, Inc. 1977. National Electrical Safety Code, American National Standard, C2. IEEE, New York.

Lebow, S.T. and J.J. Morrell. 1989. Penetration of boron in Douglas-fir and western hemlock lumber. *Forest Products Journal* 39(1):67-70.

Lew, J.D. and W.W. Wilcox. 1981. The role of selected deuteromycetes in the soft-rot of wood treated with pentachlorophenol. *Wood and Fiber* 13:252-264.

Lloyd, J.D. 1997. International status of borate preservative systems. In: *Proceedings, Second International Conference on Wood Protection with Diffusible Preservatives and Pesticides*. Proceedings No. 7284, Forest Products Society, Madison, Wisconsin. Pages 45-54.

Maki, A.C. and E.W. Kuenzi. 1965. Deflection and stresses of tapered wood beams. Res. Pap. FPL-34. USDA Forest Serv., Forest Prod. Lab., Madison, Wis. 53 pp.

Malecki, R. 1992. Regulations regarding the disposal of treated wood. IN: *The Proceedings of Wood Pole Seminar, September 17-18, 1992, Syracuse, New York*.

McOrmand, R.R. III, J. Ochrymowych, and R.D. Arsenault. 1978. Pentachlorophenol-liquified petroleum gas treatment of poles; preservative depletion and performance study. In: *Proceedings of the American Wood-Preservers' Association, Vol. 74*. AWWPA, Washington, D.C. pp. 64-80.

Morrell, J.J., P.G. Forsyth, and M.A. Newbill. 1994. Distribution of biocides in Douglas-fir poles 42 months after application of groundline preservative systems. *Forest Products Journal* 44(6):24-26.

Morrell, J.J., M. Newbill, and R.D. Graham. 1990. Evaluation of protective treatment for field-drilled bolt holes. *Forest Products Journal* 40(11/12):49-50.

Morrell, J.J., M.A. Newbill, G.G. Helsing, and R.D. Graham. 1987. Preventing decay in piers of nonpressure-treated Douglas-fir. *Forest Products Journal* 37(7/8):31-34.

Morrell, J.J., R.D. Graham, M.E. Corden, C.M. Sexton, and B.R. Kropp. 1989. Ammonium bifluoride treatment of air-seasoning Douglas-fir poles. *Forest Products Journal* 39(1):51-54.

Murarka, I.P., R. Malecki, B. Taylor, B. Hensel, and J. Roewer. 1996. Release, migration, and degradation of pentachlorophenol around in-service utility poles. *Proceedings American Wood Preservers' Association*, pages 180-187.

Newbill, M.A. and J.J. Morrell. 1992. Laboratory evaluation of chemicals for preventing decay of preservative-treated wood after field damage. *Wood Protection* 2(1):19-22.

Parmeswaran, N., W.W. Wilcox, and W.A. Côté. 1985. Transmission electron microscopy and x-ray microanalysis of potassium permanganate staining of pentachlorophenol in treated Douglas-fir. *Holzforschung* 39:259-266.

Resch, H.R. and D.G. Arganbright. 1971. Location of pentachlorophenol by electron microbe and other techniques in Cellon treated Douglas-fir. *Forest Products Journal* 21(1):38-43.

Sexton, C.M., P.G. Forsyth, and J.J. Morrell. 1994. A comparison of agar exposure and vermiculite burial methods for preparing basidiomycete-colonized wood. *Material und Organismen* 28:39-46.

Sheard, L. 1990. Evaluation of Boracol, Boracol Rh and Impel boron rods- a literature review. Unpublished Report, Danish Technological Institute, Taastrup, Denmark. 11 pages.

Wilcox, W.W. 1975. Micro-bioassay of pentachlorophenol within wood cell walls. *Forest Products Journal* 25(10):37-43.

Williams, L.H. and T.L. Amburgey. 1987. Integrated protection against lyctid beetle infestations. IV. Resistance of boron-treated wood (*Virola* spp.) to insect and fungal attack. *Forest Products Journal* 37(2):10-17.

Zabel, R.A. and J.J. Morrell. 1992. *Wood microbiology: decay and its prevention*. Academic Press, San Diego, CA. 476 pages.